

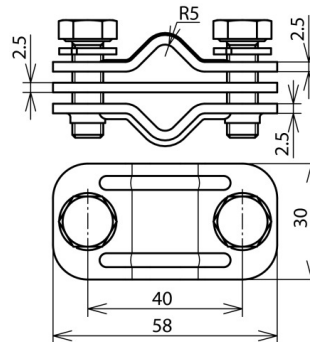

UTK 200 2X10 FL30 ZP V2A (459 200)



Figure without obligation



Disconnecting clamp with spring washer for connecting air-termination rod and conductor or down conductor and earth entry rod. Tested for lightning current carrying capability up to 200 kA (10/350 μ s).

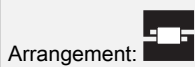

Type	UTK 200 2X10 FL30 ZP V2A
Part No.	459 200
Material	StSt
Clamping range Rd / Rd	10 / 10 mm
Clamping range Rd / FI	10 / 30 mm
Screw	M8 x 25 mm
Material of screw	StSt
Distance of screws	40 mm
Material thickness	2.5 mm
Lightning current carrying capability (10/350 μ s)	^{*)}
Standard	based on EN 62561-1
Weight	132 g
Customs tariff number (Comb. Nomenclature EU)	85389099
GTIN	4013364155527
PU	1 pc(s)

*) For exact assignment see test certificate.

We reserve the right to introduce changes in performance, configuration and technology, dimensions, weights and materials in the course of technical progress. The figures are shown without obligation.