



EFPM M10 12 V4A (478 012)

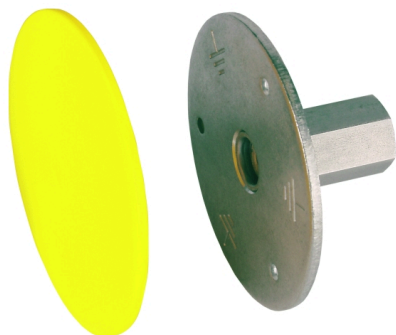
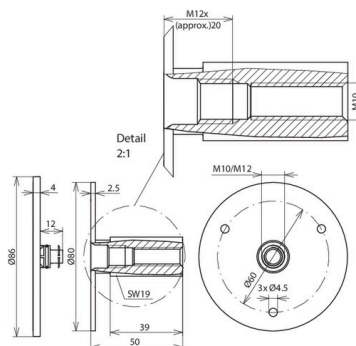

Figure without obligation



Type	EFPM M10 12 V4A
Part No.	478 012
Connection thread	M10 / M12
Material of plate	StSt (V4A)
Material No.	1.4571 / 1.4404 / 1.4401
ASTM / AISI:	316Ti / 316L / 316
Connection plate Ø	80 mm
Short-circuit current (AC 50 Hz / DC) (1 s; ≤ 300 °C)	9.3 kA (with copper cable lug)
Minimum lengths of M10 screws	35 mm (thread length 40 mm)
Minimum lengths of M12 screws	15 mm (thread length 20 mm)
Standard	EN 62561-1
Weight	182 g
Customs tariff number (Comb. Nomenclature EU)	85389099
GTIN	4013364069183
PU	20 pc(s)

We reserve the right to introduce changes in performance, configuration and technology, dimensions, weights and materials in the course of technical progress. The figures are shown without obligation.