



ZMTK 8.10 FL30 CU STTZN (460 557)

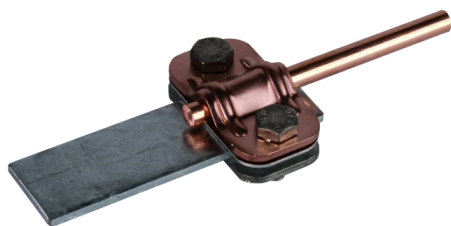
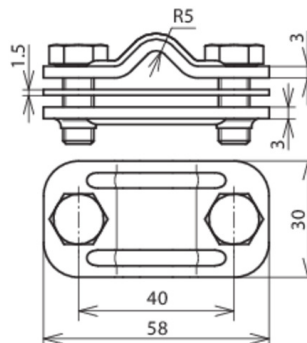

Figure without obligation



Arrangement:

Type	ZMTK 8.10 FL30 CU STTZN
Part No.	460 557
Material	Cu / St/tZn
Clamping range Rd / Fl	8-10 / 30 mm
Screw	M8 x 20 mm
Material of screw	StSt
Distance between screws	40 mm
Material thickness (t1)	3 / 1.5 mm
Lightning current carrying capability (10/350 µs)	100kA *)
Standard	EN 62561-1
Weight	80 g
Customs tariff number (Comb. Nomenclature EU)	85389099
GTIN	4013364034242
PU	50 pc(s)

*) For exact classification, see test certificate.

We reserve the right to introduce changes in performance, configuration and technology, dimensions, weights and materials in the course of technical progress. The figures are shown without obligation.