



RRS 120 B11 CU (420 127)

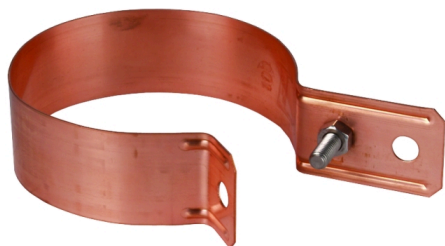
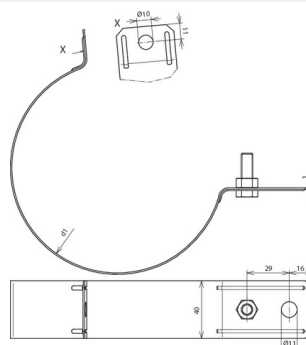

Figure without obligation



Arrangement:

Type	RRS 120 B11 CU
Part No.	420 127
Material	Cu
Clamping range pipe Ø (d1)	120 mm
Hole Ø	11 mm
Screw	⚙ M8 x 25 mm
Material of screw / nut	StSt
Lightning current carrying capability (10/350 µs)	100 kA *)
Standard	EN 62561-1
Weight	186 g
Customs tariff number (Comb. Nomenclature EU)	85389099
GTIN	4013364045804
PU	1 pc(s)

*) For exact assignment, see test certificate.

We reserve the right to introduce changes in performance, configuration and technology, dimensions, weights and materials in the course of technical progress. The figures are shown without obligation.