



RRS 100 B11 CU (420 107)

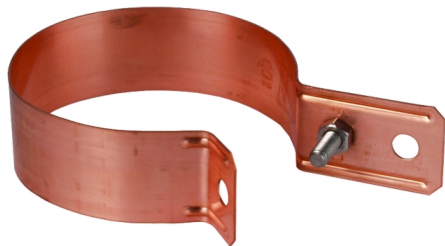
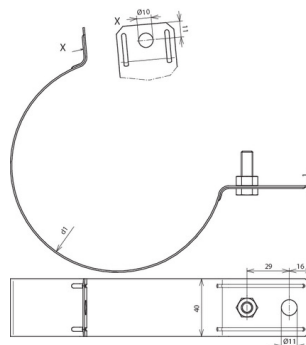

Figure without obligation



Arrangement:

Type	RRS 100 B11 CU
Part No.	420 107
Material	Cu
Clamping range pipe Ø (d1)	100 mm
Hole Ø	11 mm
Screw	⚙ M8 x 25 mm
Material of screw / nut	StSt
Lightning current carrying capability (10/350 µs)	100 kA *)
Standard	EN 62561-1
Weight	158 g
Customs tariff number (Comb. Nomenclature EU)	85389099
GTIN	4013364045828
PU	1 pc(s)

*) For exact assignment, see test certificate.

We reserve the right to introduce changes in performance, configuration and technology, dimensions, weights and materials in the course of technical progress. The figures are shown without obligation.