



FK KB 6.10 KBF0.7 10 CU (365 027)

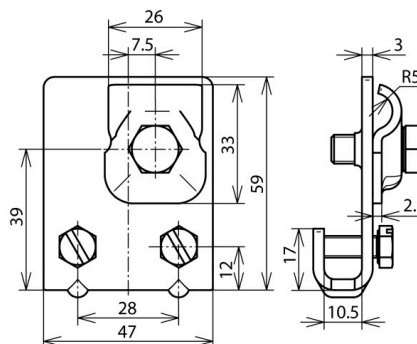

Figure without obligation



Arrangement:

Type	FK KB 6.10 KBF0.7 10 CU
Part No.	365 027
Clamping range of seam	0.7-10 mm
Material of clamp	Cu
Material thickness (t1)	3 mm
Clamping range Rd	6-10 mm
Screw	☛ M6 x 16 / ☛ M8 x 20 mm
Material of screw / nut	StSt
Lightning current carrying capability (10/350 µs)	☛ 50kA ^{*)}
Standard	EN 62561-1
Weight	146 g
Customs tariff number (Comb. Nomenclature EU)	85389099
GTIN	4013364035133
PU	50 pc(s)

*) For exact assignment see test certificate.

We reserve the right to introduce changes in performance, configuration and technology, dimensions, weights and materials in the course of technical progress. The figures are shown without obligation.