

KS 10 B11 STTZN (345 010)

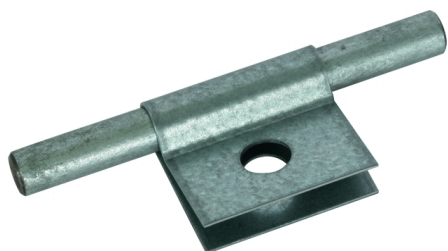
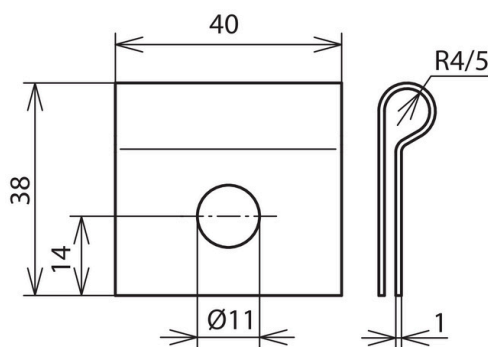

Figure without obligation



Type	KS 10 B11 STTZN
Part No.	345 010
Clamping range Rd	10 mm
Material	St/tZn
Fixing hole Ø	11 mm
Weight	25 g
Customs tariff number (Comb. Nomenclature EU)	85389099
GTIN	4013364025080
PU	100 pc(s)

We reserve the right to introduce changes in performance, configuration and technology, dimensions, weights and materials in the course of technical progress. The figures are shown without obligation.