

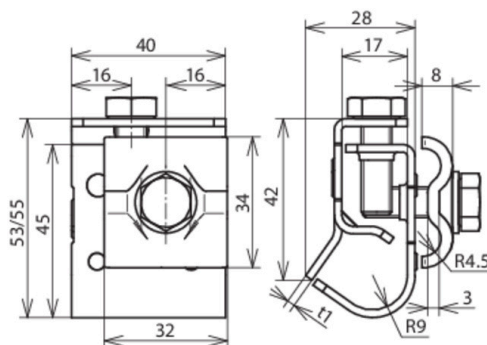

DRK DUL 8.10 W16.22 V2A (339 059)



Figure without obligation



Arrangement:

Type	DRK DUL 8.10 W16.22 V2A
Part No.	339 059
Clamping range bead	16-22 mm
Material of gutter clamp	StSt
Clamping range Rd	8-10 mm
Material of conductor clamp	StSt
Width / material thickness	40 / 2 mm
Screw	M8 x 20 / 25 mm
Material of screw	StSt
Lightning current carrying capability (10/350 μs)	100 kA / 50 kA *)
Standard	EN 62561-1
Weight	132 g
Customs tariff number (Comb. Nomenclature EU)	85389099
GTIN	4013364096301
PU	25 pc(s)

*) See test certificate for exact classification.

We reserve the right to introduce changes in performance, configuration and technology, dimensions, weights and materials in the course of technical progress. The figures are shown without obligation.