



KS 8.10 8.10 FL30 OV CU (314 307)

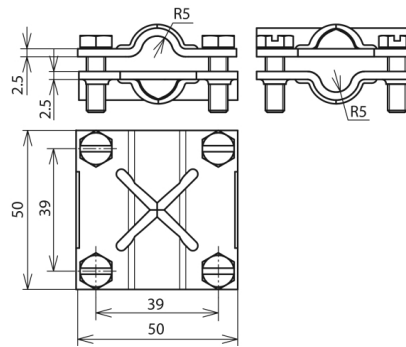
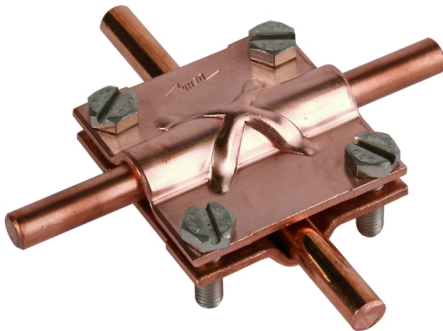

Figure without obligation



Arrangement:

Type	KS 8.10 8.10 FL30 OV CU
Part No.	314 307
Material of clamp	Cu
Clamping range Rd / Rd	8-10 / 8-10 mm
Clamping range Rd / FI	8-10 / 30 mm
Clamping range FI / FI	30 / 30 mm
Screw	⚙️ M6 x 20 mm
Material of screw	StSt
Dimensions	50 x 50 x 2.5 mm
Lightning current carrying capability (10/350 μs)	100kA ^{*)}
Standard	EN 62561-1
Weight	132 g
Customs tariff number (Comb. Nomenclature EU)	85389099
GTIN	4013364096417
PU	50 pc(s)

^{*)} For exact assignment see test certificate.

We reserve the right to introduce changes in performance, configuration and technology, dimensions, weights and materials in the course of technical progress. The figures are shown without obligation.