

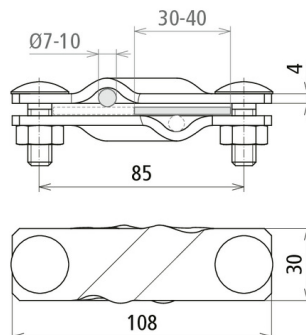

## SVK 7.10 7.10 FL40 STTZN (308 320)



Figure without obligation



Type	SVK 7.10 7.10 FL40 STTZN
Part No.	308 320
Material of clamp	St/tZn
Clamping range Rd / Rd	7-10 / 7-10 mm
Clamping range Rd / FI	7-10 / 30-40 mm
Clamping range FI / FI	30-40 / 30-40 mm
Screw	☛ M10 x 30 mm
Material of screw / nut	St/tZn
Dimensions (l1 x d1)	108 x 4 mm
Lightning current carrying capability (10/350 µs)	/  *)
Standard	EN 62561-1
Short-circuit current (a.c. 50 Hz / d.c.) (1 s; ≤ 300 °C)	14.0 kA
Weight	266 g
Customs tariff number (Comb. Nomenclature EU)	85389099
GTIN	4013364028531
PU	25 pc(s)

\*) For exact assignment see test certificate.

We reserve the right to introduce changes in performance, configuration and technology, dimensions, weights and materials in the course of technical progress. The figures are shown without obligation.