



## VK A UNI ST (308 025)

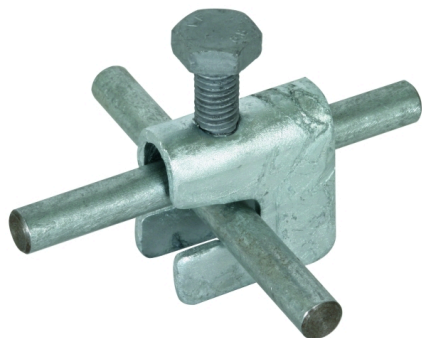
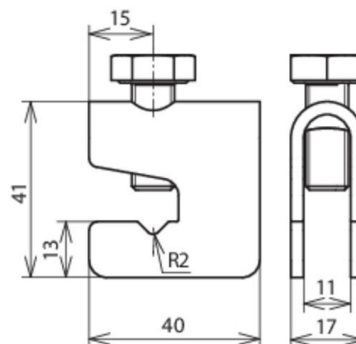

Figure without obligation



Type	VK A UNI ST
Part No.	308 025
Material	St/tZn
Clamping range Rd / Rd	(+) 6-10 / 6-10 mm
Clamping range Rd / FI	(+) 6-10 / 30 mm
Clamping range FI / FI	(II) 30 / 30 mm
Screw	☛ M10 x 25 mm
Material of screw	StSt
Standard	EN 62561-1
Short-circuit current (a.c. 50 Hz / d.c.) (1 s; ≤ 300 °C)	9 kA
Weight	100 g
Customs tariff number (Comb. Nomenclature EU)	85389099
GTIN	4013364035881
PU	50 pc(s)

We reserve the right to introduce changes in performance, configuration and technology, dimensions, weights and materials in the course of technical progress. The figures are shown without obligation.