

## DLH FS 8 H36 L170 BR V2A (204 938)

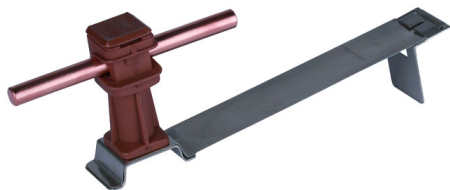
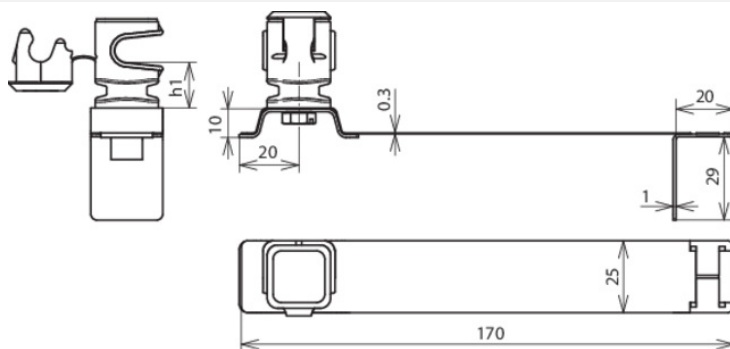

Figure without obligation



Type	DLH FS 8 H36 L170 BR V2A
Part No.	204 938
Type of roof conductor holder	FLEXIsnap
Material of roof conductor holder	StSt
Length of brace	170 mm
Height of conductor holder (h1)	36 mm
Material of conductor holder	plastic
Colour of conductor holder	brown •
Conductor support Rd	8 mm
Type of conductor holder	DEHNsnap
Female thread	M6
Type of roofing	interlocking tiles
Conductor routing	loose
Fixing possibility	for hooking at interlocking tiles, with flexible brace
Weight	47 g
Customs tariff number (Comb. Nomenclature EU)	85389099
GTIN	4013364029989
PU	50 pc(s)

We reserve the right to introduce changes in performance, configuration and technology, dimensions, weights and materials in the course of technical progress. The figures are shown without obligation.