

D BEB 5 - L1500 / EBS 15-03-19 (419 503)

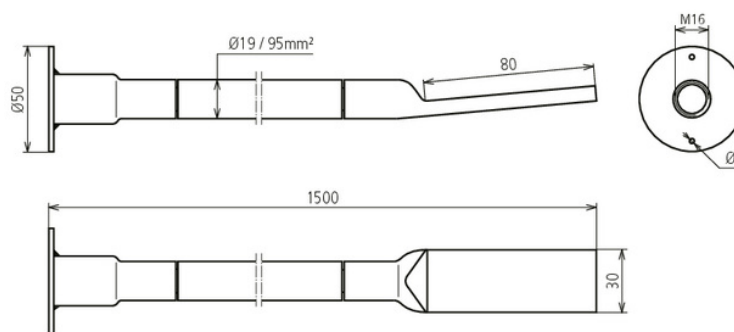

Figure without obligation



Copper cable earthing bridges

The earthing bridges are designed for earthing, current return circuits and equipotential bonding in railway line applications. This version is installed flush with the surface. The copper-plated steel lug pressed onto the copper cable is welded to the earthing reinforcement. The flexibility of the cable makes installation in the reinforcement easier for the user. The earthing bridges also have technical approval from DB Netz AG and can be reliably used in planning.

Type	D BEB 5 - L1500 / EBS 15-03-19
Part No.	419 503 NEW
Material of plate	StSt
Material No.	1.4301
Material of socket	St / Cu
Material of lug	St / Cu
Material of cable	Cu
Short-circuit current	> 25 kA
Test current	40 kA / 100 ms
Standard	Ril 997.0205A01
Short-circuit current (AC 50 Hz / DC) (1 s; ≤ 300°C)	12.6 kA
Thread	M16
Diameter of connection plate	50 mm
Cable	NY-Y-O
Cable cross-section	95 mm ²
Cable diameter	19 mm
Dimensions of lug	80 x 30 mm
Length	1500 mm
DB drawing No.	3 Ebs 15.03.19 - 32
Weight	2.100 g
Customs tariff number (Comb. Nomenclature EU)	85389099
GTIN	4013364458413
PU	1 pc(s)

We reserve the right to introduce changes in performance, configuration and technology, dimensions, weights and materials in the course of technical progress. The figures are shown without obligation.