

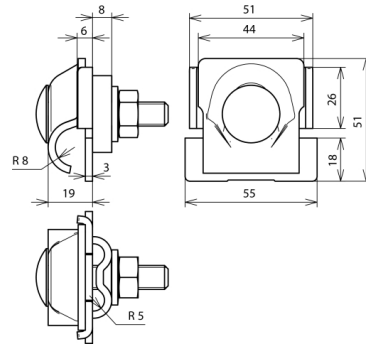

FSK 2X8.10 16 FRM10X50 AL (380 116)



Figure without obligation



Type	FSK 2X8.10 16 FRM10X50 AL
Part No.	380 116
Material of clamp	Al
Clamping range of air-termination rod	16 mm
Clamping range Rd	2x 8-10 mm
Material thickness	3 mm
Screw	⬆ M10 x 45 mm
Material of screw / nut	StSt
Material of plate	StSt
Lightning current carrying capability (10/350 μs)	*)
Standard	EN 62561-1
Weight	100 g
Customs tariff number (Comb. Nomenclature EU)	85389099
GTIN	4013364133280
PU	50 pc(s)

*) For exact assignment see test certificate.

We reserve the right to introduce changes in performance, configuration and technology, dimensions, weights and materials in the course of technical progress. The figures are shown without obligation.