



UEK 8.10 AQ4 50 HKSM8 V2A (540 250)

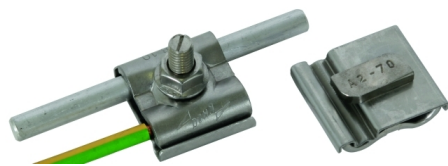
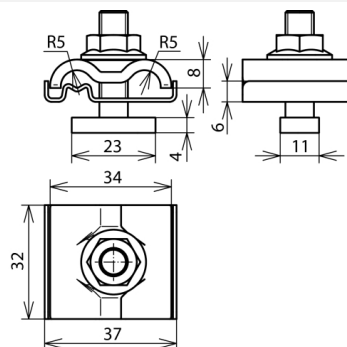

Figure without obligation



Earthing clamps for integrating mounting systems, e.g. of PV installations in the functional equipotential bonding/functional earthing (black conductor possible) and lightning equipotential bonding according to IEC/EN 62305-3.

The StSt contact plate (intermediate element) allows different conductor materials (Cu, Al, St/tZn and StSt) to be connected to the normal mounting systems, e.g. to aluminium, without the risk of contact corrosion.

The double clamp design allows easy and quick interconnection of the profiles, e.g. by feed-through wiring.



Arrangement:

Type	UEK 8.10 AQ4 50 HKSM8 V2A
Part No.	540 250
Material of clamp	StSt
Clamping range Rd	8-10 mm
Connection (solid / stranded)	4-50 mm ²
Screw	hammer-head bolt M8 x 30 mm
Self-locking nut	width across flats 13 mm
Material of screw / nut	StSt
Lightning current carrying capability (10/350 µs)	100kA ^{*)}
Standard	EN 62561-1
Weight	60 g
Customs tariff number (Comb. Nomenclature EU)	85389099
GTIN	4013364138650
PU	50 pc(s)

^{*)} For exact assignment, see test certificate.

We reserve the right to introduce changes in performance, configuration and technology, dimensions, weights and materials in the course of technical progress. The figures are shown without obligation.