

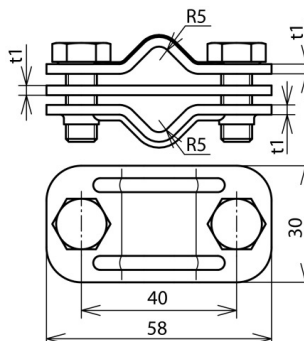

**UTK 8.10 8.10 ZP CU (459 127)**



Figure without obligation



Arrangement:

Type	UTK 8.10 8.10 ZP CU
Part No.	459 127
Material	Cu
Clamping range Rd / Rd	8-10 / 8-10 mm
Screw	M8 x 20 mm
Material of screw	StSt
Distance between screws	40 mm
Material thickness (t1)	3 mm
Lightning current carrying capability (10/350 μs)	100 kA *)
Standard	EN 62561-1
Weight	152 g
Customs tariff number (Comb. Nomenclature EU)	85389099
GTIN	4013364119291
PU	1 pc(s)

\*) For exact classification, see test certificate.

We reserve the right to introduce changes in performance, configuration and technology, dimensions, weights and materials in the course of technical progress. The figures are shown without obligation.