

AE BO10 KF HVI 20 SW V2A (819 199)

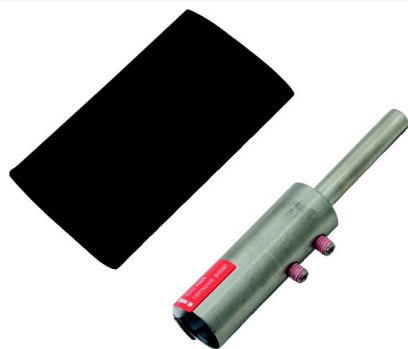
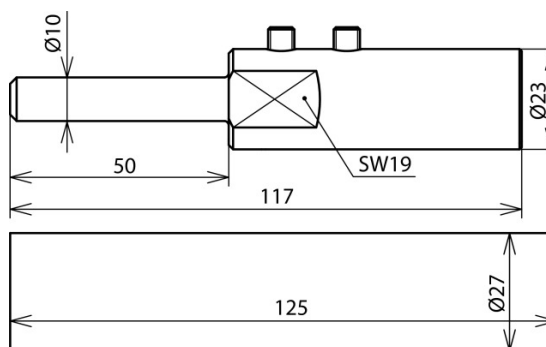

Figure without obligation



Connection element for sealing the HVI long Conductor for establishing the sealing end of the conductor for other parts of the external lightning protection or earth-termination system (incl. one heat-shrinkable sleeve).

Type	AE BO10 KF HVI 20 SW V2A
Part No.	819 199
Material	StSt
Connection	bolt Ø10 mm, L 50 mm
Diameter Ø connection element	23 mm
Screw	threaded bolt M6 x 8 mm
Standard	DIN IEC/TS 62561-8 (VDE V 0185-561-8)
Weight	184 g
Customs tariff number (Comb. Nomenclature EU)	85389099
GTIN	4013364222274
PU	1 pc(s)

We reserve the right to introduce changes in performance, configuration and technology, dimensions, weights and materials in the course of technical progress. The figures are shown without obligation.