

PHILIPS

hue personal
wireless
lighting

Lily extension



HUE serial number



User manual
Benutzerhandbuch
Notice d'emploi
Manual de usuario
Manual do usuário
Manuale d'uso

Incl.

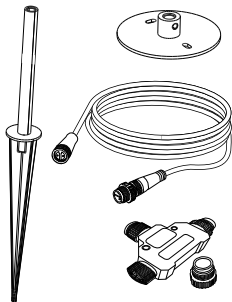
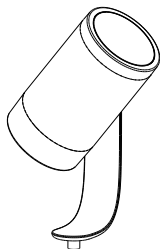

Excl.

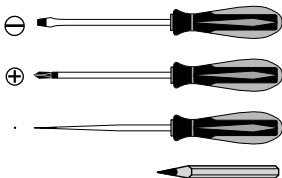
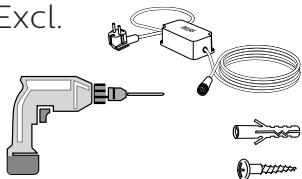

IP65



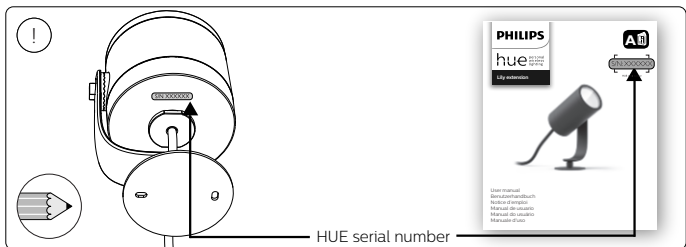
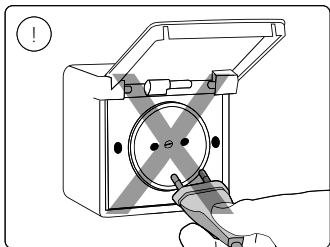
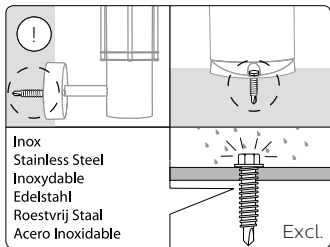

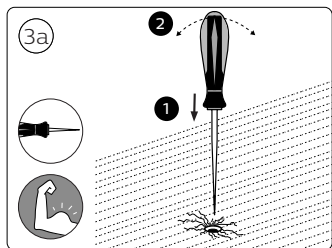
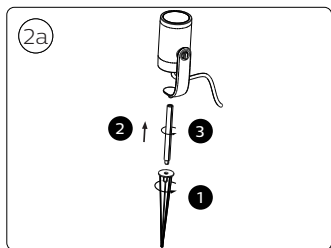
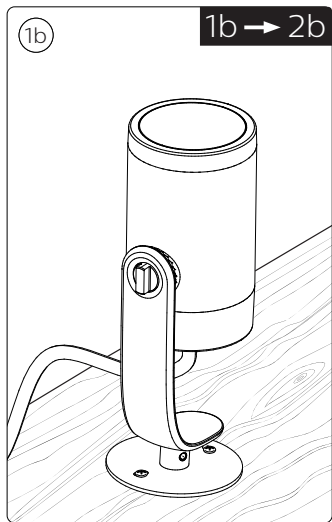
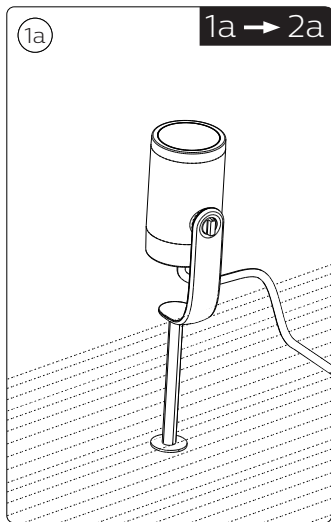

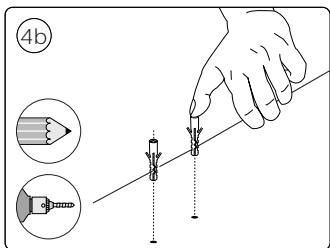
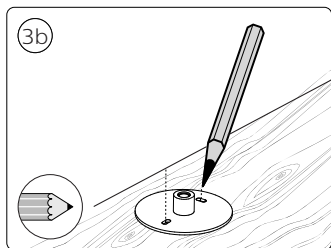
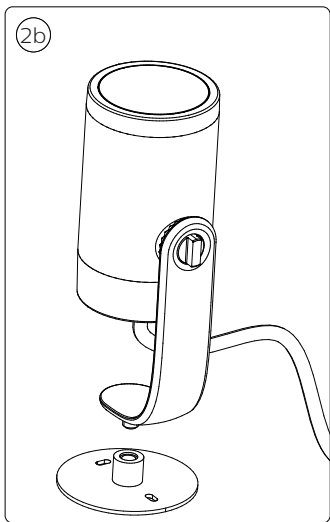
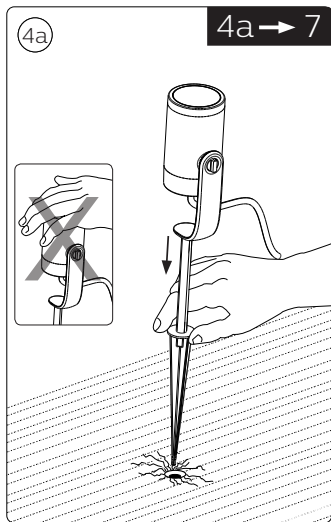

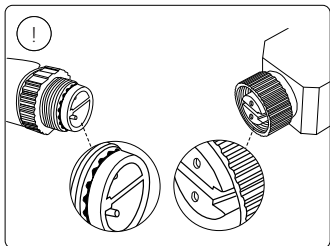
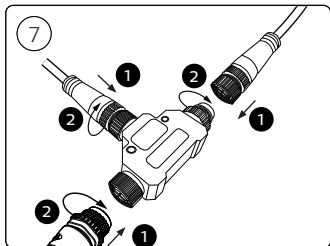
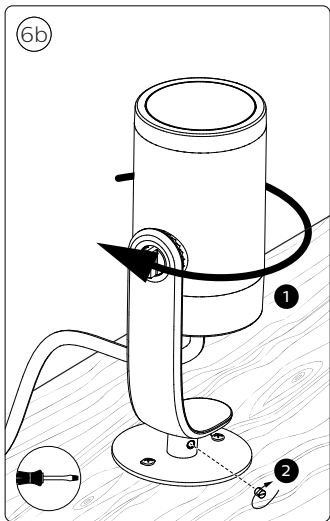
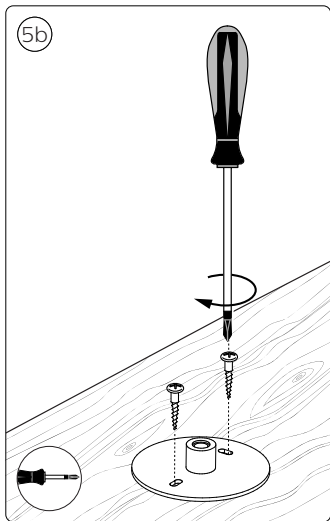

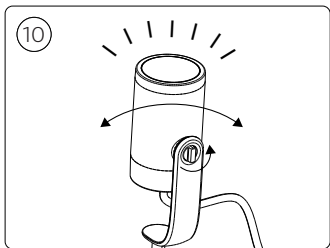
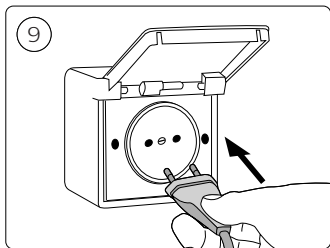
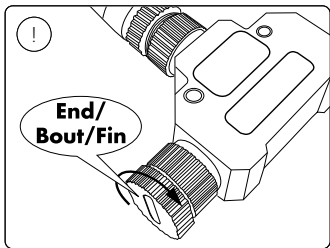
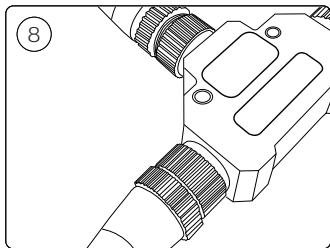

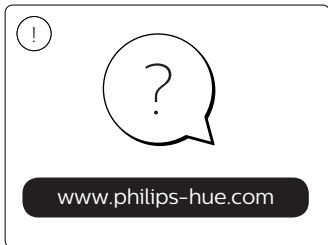
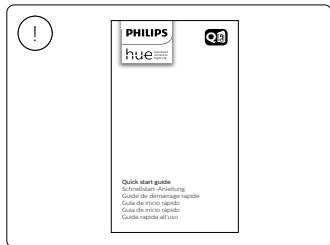



- EN** Use only with Philips Hue 24V \equiv SELV IP67 LED power supply!
- DE** Verwendung nur mit Philips Hue 24V \equiv SELV IP67 LED-Stromversorgung!
- FR** Utiliser uniquement avec l'alimentation LED Philips Hue 24V \equiv SELV IP67!
- ES** Se utiliza solo con la fuente de alimentación LED Philips Hue SELV 24V \equiv IP67!
- PT** Utilize apenas com fonte de alimentação LED SELV Philips Hue de 24V \equiv IP67!
- IT** Da utilizzare solo con un alimentatore LED Philips Hue 24V \equiv IP67!

Philips Hue Low-volt system (24V)

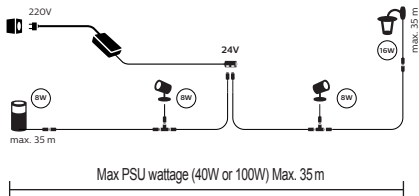



Signify
I.B.R.S. / C.C.R.I. Numéro 10461
5600 VB Eindhoven,
the Netherlands
☎00800-74454775

Signify Australia Limited
65 Epping Road, North Ryde,
NSW, 2113 Australia
Toll Free number: 1300 304 404

Signify New Zealand Limited
123 Carlton Gore Road
Newmarket, Auckland 1023
New Zealand
Tel: 0800 454 448

© 2021 Signify Holding
All rights reserved

www.philips-hue.com

17415/**/P7
4404 029 09575
Last update: 05/2021