

PHILIPS

Crust



User manual
Benutzerhandbuch
Notice d'emploi
Manual de usuario
Manual do usuário
Manuale d'uso
Gebruiksaanwijzing

Incl.

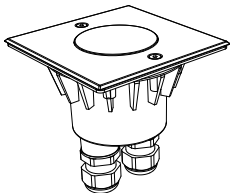

Excl.

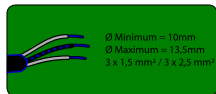

IP44



3/8"



8mm



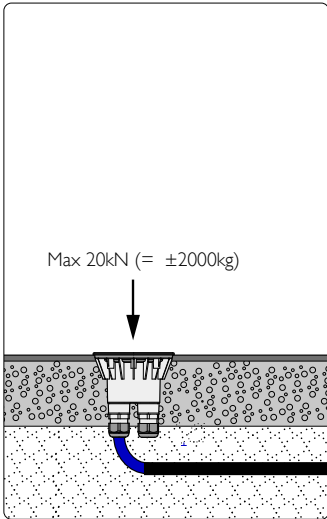
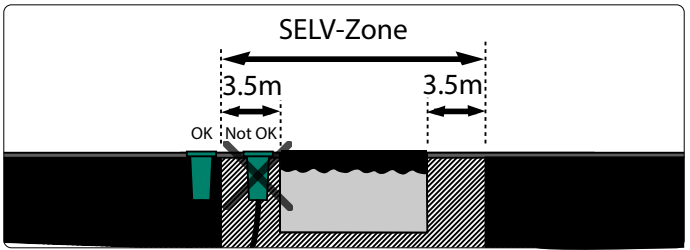

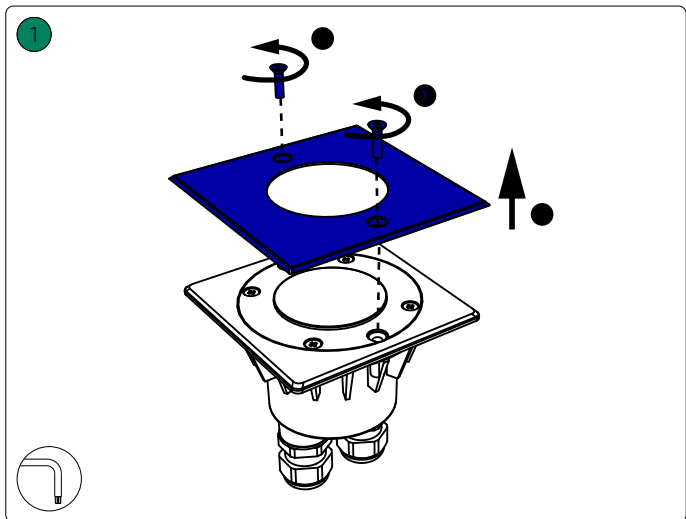
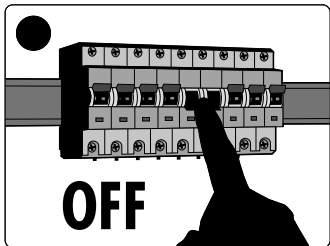
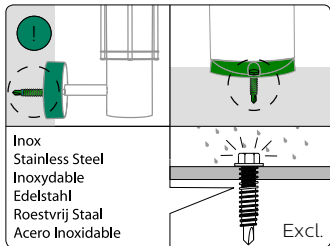

2

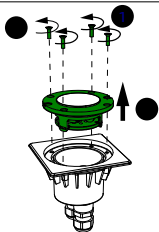

3

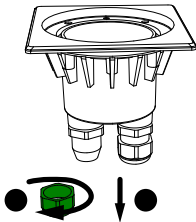

4

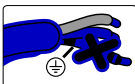

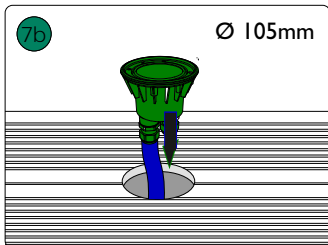
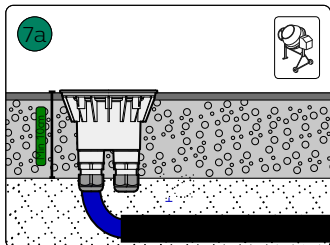
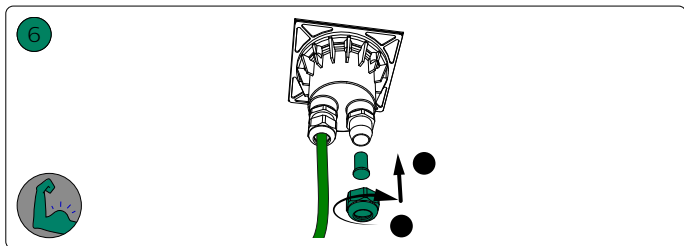
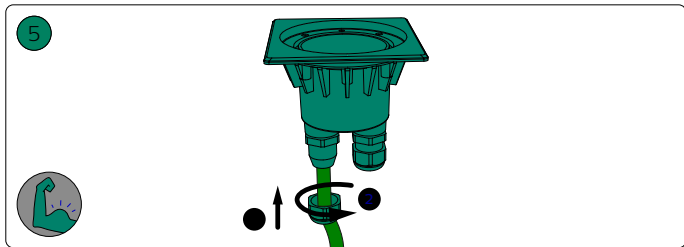

8

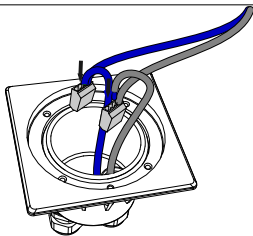

9

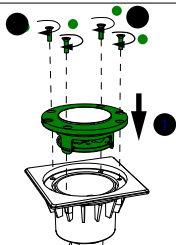

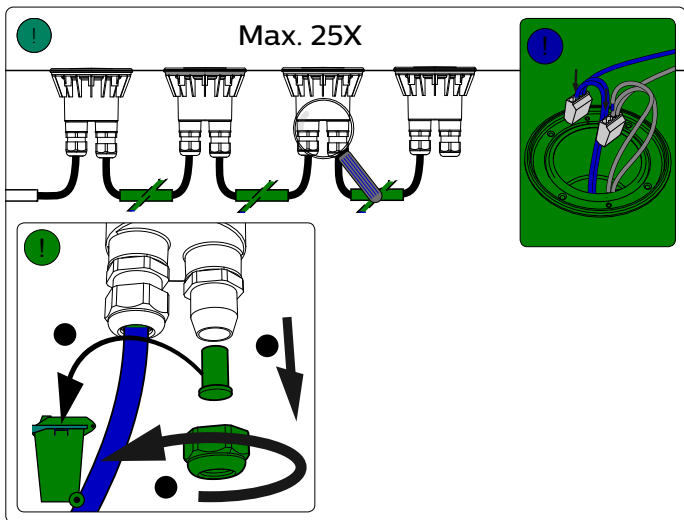
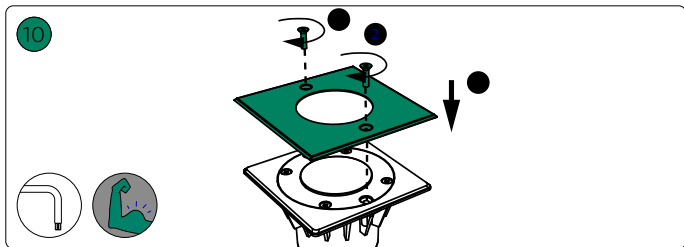

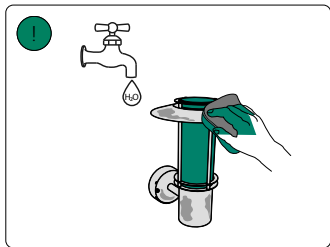
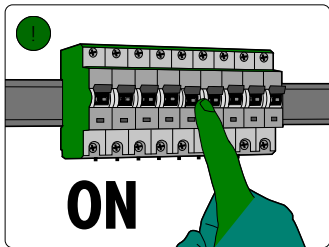
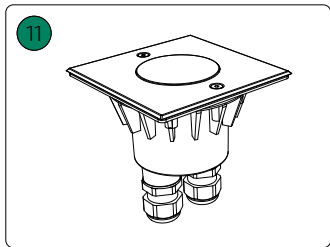

- EN** Attention: The luminaire shall be used in restricted accessible areas only (e.g. pedestrian and bicycle zones).
- DE** Achtung: Die Leuchte darf nur in Bereichen verwendet werden, die mit Einschränkungen zugänglich sind (z. B. für Fußgänger und Fahrräder).
- FR** Attention : ce luminaire ne peut être utilisé que dans des zones d'accès restreint (aux piétons et cyclistes par ex).
- NL** Let op: De armatuur mag alleen worden gebruikt in beperkt toegankelijke gebieden (bijv. voor voetgangers en fietsers).
- ES** Atención: La luminaria deberá usarse únicamente en áreas con acceso restringido (p. ej., zonas peatonales y para bicicletas).
- PT** Atenção: a luminária poderá ser utilizada apenas em áreas com acesso restrito (por exemplo, zonas pedestres e para bicicletas).
- IT** Attenzione: l'apparecchio d'illuminazione dev'essere utilizzato solo in aree accessibili (es. pedoni e biciclette).

- DA** Bemærk: Armaturet må kun bruges i områder med begrænset adgang (f.eks. fodgængere og cykler).
- FI** Huomio: Valaisinta saa käyttää ainoastaan alueilla, joille on rajoitettu pääsy (esim. jalankulkijoille tai polkupyörille).
- SV** Obs! Armaturen ska endast användas i områden med begränsat tillträde (t.ex. gång- och cykeltväg).
- NO** Merk: lysarmaturen skal kun brukes i områder med begrenset adgang (f.eks. fotgjengere og sykler).
- EL** Προσοχή: Το φωτιστικό προορίζεται για χρήση μόνο σε χώρους περιορισμένης πρόσβασης (π.χ. χώρους πεζών και ποδηλάτων).
- TR** Dikkat: Aydınlatma armatürü, yalnızca sınırlı erişilebilir alanlarda (ör. yaya ve bisiklet yolları) kullanılmalıdır.
- BG** Внимание: Осветителното тяло трябва да се използва само в ограничени достъпни зони (например за пешеходни и велосипеди).
- HU** Figyelem: Ezt a lámpatestet csak korlátozottan hozzáférhető helyen szabad használni (pl. gyalogosok és kerékpárosok által használt területen).
- SL** Pozor: svetilo je dovoljeno uporabljati samo na območjih z omejenim dostopom (npr. pešci in kolesa).
- HR** Pažnja: svjetiljka se smije koristiti isključivo u područjima ograničenog pristupa (npr. pješacima i biciklima).
- MK** Внимание: светлечкото тело треба да се користи само во области со ограничен пристап (на пример, пешаци и велосипедисти).
- SR** Pažnja: svjetiljka će se koristiti samo u prostorima sa ograničenim pristupom (npr. pešaci i biciklisti).
- CZ** Upozornění: Svítidlo je třeba používat výhradně v oblastech s omezeným přístupem (například pouze pro pěši nebo cyklisty).
- SK** Upozornenie: Svetidlo je určené na používanie výhradne v oblastiach s obmedzeným prístupom (napríklad iba pre chodcov alebo cyklistov).
- PL** Uwaga: Oprawę można stosować tylko w miejscach o ograniczonym dostępie (np. poza zasięgiem pieszych i rowerzystów).
- RO** Atenție: corpul de iluminat va fi utilizat numai în zone cu acces restricționat (de exemplu, pentru pietoni sau biciclete).
- SQ** Kujdes: Abazhuri duhet të përdoret vetëm në zona me akses të kufizuar (p.sh. këmbësorët dhe biçikletat).
- LV** Uzmanību! Gaismeklis jālieto tikai ierobežotās piekļuves vietās (piemēram, gājēju un velosipēdistu zonās).
- LT** Dėmesio: šis šviestuvas turi būti naudojamas tik vietose su ribota prieiga (pvz., pėstiesiems ir dviratininkams).
- ET** Tähelepanu: valgustit tohib kasutada ainult piiratud juurdepääsuga aladel (nt jalakäijatele ja jalgratturitele).

تنبیه: يجب استخدام المصباح في المناطق التي يتم تقييد الوصول إليها فقط (مثل الأماكن المخصصة للمشاة والراجات).



Signify
I.B.R.S. / C.C.R.I. Numéro 10461
5600 VB Eindhoven,
the Netherlands
☎00800-74454775

© 2021 Signify Holding
All rights reserved

www.philips.com/lighting

17356/**/P0
4404 029 06543
Last update: 06/2021