

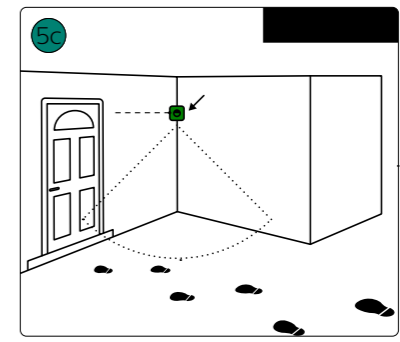

User manual
 Benutzerhandbuch
 Notice d'emploi
 Manual do usuário
 Manuale d'uso

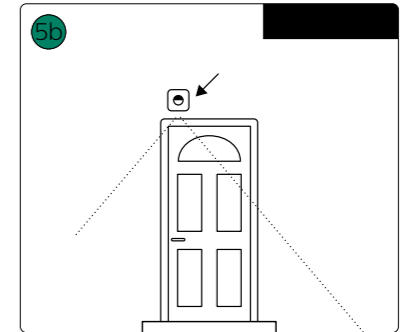
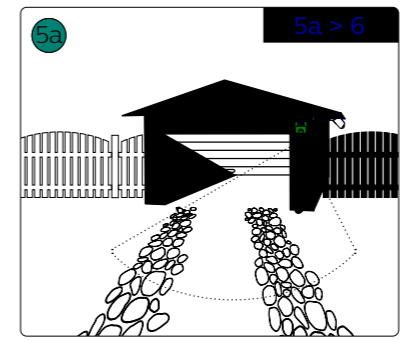
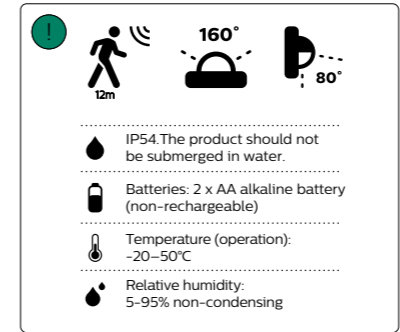
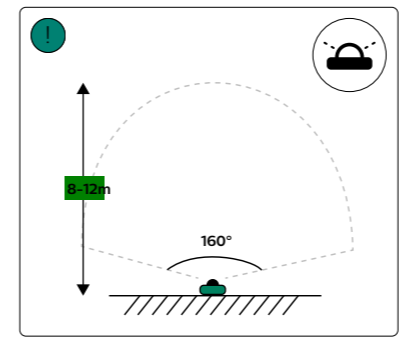
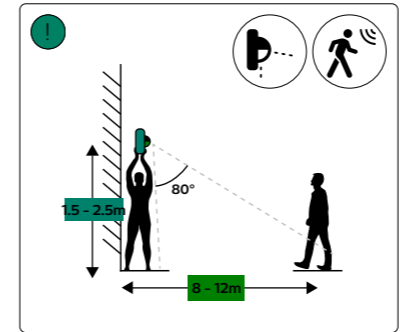
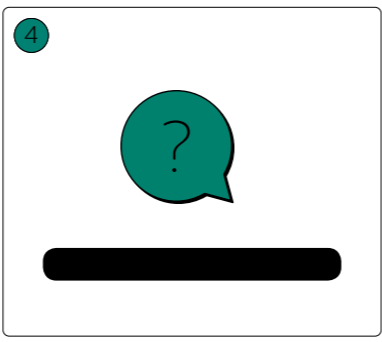
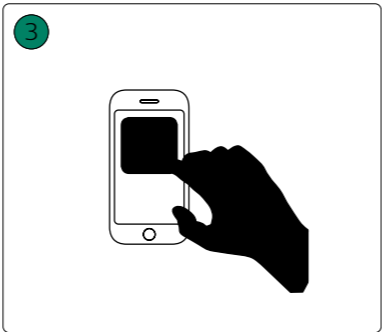
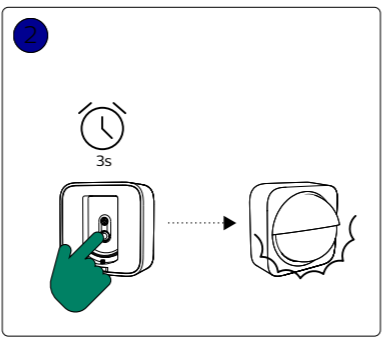
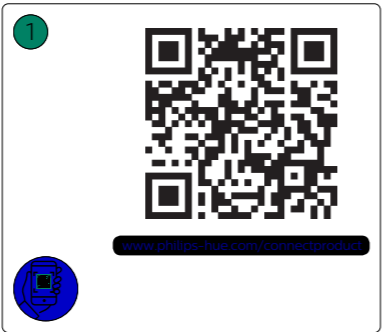
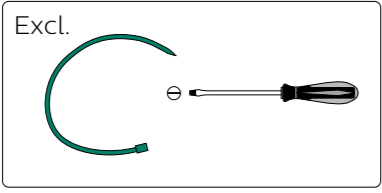
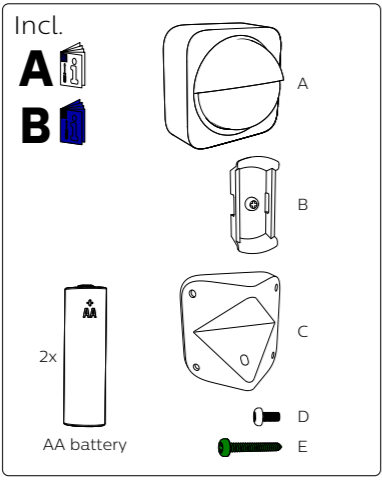

Signify
 I.B.R.S. / C.C.R.I. Numéro 10461
 5600 VB Eindhoven,
 the Netherlands
 000800-74454775

www.philips-hue.com
 3222 639 07792
 Last update: 07/2021

