

Automatic transfer switch 4 226 81

EN

ENGLISH

3

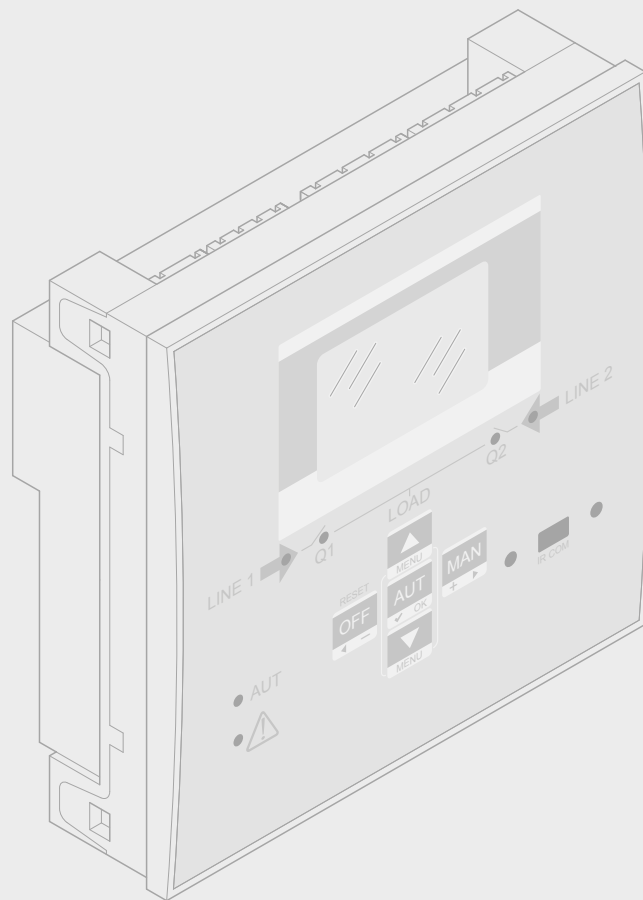



WARNING

- Read carefully the manual before the installation or use, taking count of the informations of instruction sheet given with to the product.
- These equipments have to be installed by qualified personnel, in compliance to local standards, to avoid damages or safety hazards.
- Before any device maintenance operation, remove the supply from measuring inputs or isolate them cutting the supply from other sources.
- Legrand assumes no responsibility if the device isn't properly used, if installative informations aren't respected or if the device is tampered.
- Products described here below are subject to alterations and changes without prior notice. For this reason the catalogues data couldn't have contractual value.
- Clean the instrument with a soft dry cloth; do not use abrasives, liquids.
- Due of presence of electrical connections, the safety standards have to be respected.
- The ATS is supplied with Legrand standard parameters. These couldn't respect the necessity of the specific application/ installation. For this reason it is necessary to know the parameters and eventually to modify them in order to better integrate the device to the plant.



SAFETY INSTRUCTIONS

This product should be installed in compliance with installation rules, preferably by a qualified electrician. Incorrect installation and use can lead to risk of electric shock or fire.

Before carrying out the installation, read the instructions and take account of the product's specific mounting location.

Do not open up, dismantle, alter or modify the device.

All Legrand products must be opened and repaired exclusively by personnel trained and approved by Legrand. Any unauthorized opening or repair completely cancels all liabilities and the rights to replacement and guarantees.

Use only Legrand brand accessories.

Index

1. General features	6
1.1 Description	6
1.2 Applications	6
1.3 Installation	6
2. ATS front panel description	7
2.1 Selection keys	7
2.2 LEDs	7
2.3 IR Input	7
3. Operating mode	8
3.1 Reset mode (OFF-RESET)	8
3.2 Manual mode (MAN)	8
3.3 Automatic mode (AUT)	9
4. Power-up	9
5. Main menu	10
6. Password access	11
7. Display pages	12
8. Communication	14
8.1 User Alarms (UAx)	15
8.2 Counters (CNTx)	15
9. Keypad lock	16
10. Programmation	16
10.1 Parameter setting (setup) from frontal panel	16
10.2 Parameter setting (setup) with PC	17
10.3 Parameter setting with smartphone or tablet	18
10.4 IR port	18
11. Menu	19

12. Parameters	20
12.1 Description of "utility" menu	20
12.2 Description of "general" menu	21
12.3 Description of "password" menu	21
12.4 Description of "Load changeover" menu	22
12.5 Description of "Voltage control line 1 S.Q1" menu	24
12.6 Description of "Voltage control line 2 S.Q2" menu	26
12.7 Description of "Programmable inputs" menu	27
12.8 Description of "Programmable outputs" menu	27
12.9 Description of "Alarms" menu	28
12.10 Alarm properties	28
12.11 Alarm table	29
12.12 Alarm description	30
13. Function I/O	31
13.1 Programmable inputs function table	31
13.2 Output function table	32
14. Installation	34
15. Terminals position	35
16. Dimensions	35
17. Technical characteristics	36

1. General features

The automatic transfer switch has been designed for switching applications between two power sources (power grids or generators). ATS has an LCD screen to provide a clear and intuitive user interface.

1.1 Description

- 128x80 pixel, backlit LCD screen with 4 grey levels.
- 5 keys for functions and setting.
- 4 LEDs for plant synoptic (source line and breakers status).
- 2 LEDs for alarm presence and AUTO mode active.
- 5-language text for measurements, settings and messages.
- Programmable I/O functions.
- Fully user-definable alarm properties.
- Line 1: 3-phase + neutral voltage reading input (S.Q1).
- Line 2: 3-phase + neutral voltage reading input (S.Q2).
- 100-240VAC power supply.
- Voltage thresholds with programmable hysteresis.
- Front optical programming interface, galvanically isolated, which can be connected with USB and WiFi dongles.
- 6 programmable digital inputs (negative).
- 6 + 1 outputs:
 - 6 relays with NO contact 8A 250VAC.
 - 1 relay with changeover contact 8A 250VAC.
- IP 40 front protection.
- Compatible with App and SW ACU.

1.2 Applications

- To check and to manage lines (line-to-line (U-U), line-generator (U-G) or generator-generator (G-G)).
- Control of motorized circuit breakers or contactors.
- Control of voltage source for three-phase, two-phase or single-phase systems.
- Control of phase-phase and / or phase-neutral voltages.
- Controls of undervoltage, overvoltage, phase loss, asymmetry, minimum frequency, maximum frequency.

1.3 Installation

- Install the unit following the instruction sheet attached to the product. Evaluate if the default configuration is in compliance with the desired one. Otherwise it is necessary modify the configuration. Check the wiring diagram supplied by Legrand in order to correctly connect the unit and others Legrand devices.
- The ATS standard configuration guarantees the correct work of devices if wiring diagrams supplied are respected.



WARNING

The change of parameters, of input functions, of output functions etc... causes a functional change. This could cause incompatibility with standard wiring diagrams. It is recommended to evaluate changes of parameters or functional modes after having read the ATS user manual.

- At first power on, the OFF/RESET mode is activated on the ATS.

2. ATS front panel description

2.1 Selection keys

- **OFF button (F)** – It selects the OFF operating mode.
- **AUT button (G)** – It selects the automatic mode. Green AUT LED (D) lights (when selected).
- **MAN button (H)** – It selects the manual operating mode.
- **▲ and ▼ keys (I)** - Used to scroll through the display pages or to select the list of options in a menu. Simultaneously pressing of ▼ and ▲ recalls up the main menu.

2.2 LEDs

- **AUT LED (green) (D)** – It indicates the automatic mode active.
- **Alarm LED (red) (E)** – Flashing, it indicates an active alarm.
- **Line 1 voltage status LED (green) (C)** – It indicates the line voltage of source 1 S.Q1 is within the programmed limits.
- **Line 2 voltage status LED (green) (C)** - It indicates the line voltage of source 2 S.Q2 is within the programmed limits.
- **Q1 status LED (yellow) (B)** - If fixed, it indicates the open or closed state of the devices Q1 source line 1. If flashing, it indicates a mismatch between the desired state of the breaker and its true state detected by the feedback input.
- **Q2 status LED (yellow) (B)** - If fixed, it indicates the open or closed state of the device Q2 source line 2 breaker. If flashing, it indicates a mismatch between the desired state of the breaker and its true state detected by the feedback input.

N.B. If the LED is on, the relative function is activated.

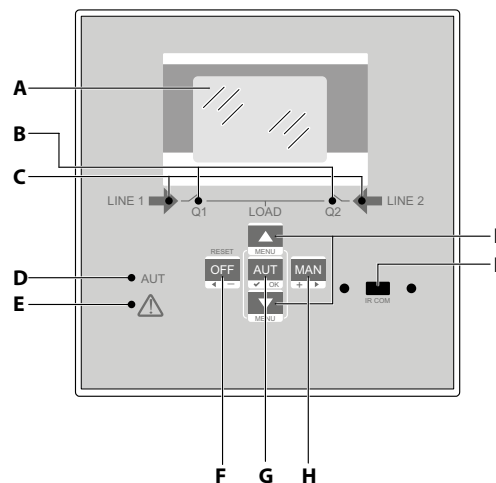

Fig. 1 - Frontal panel

2.3 IR Input

- **IR Input (L)** – Connecting IR port to connect IR-USB or IR-WiFi dongle accessories. They allow the dialogue between ATS and SW ACU or APP ACU.

3. Operating mode

With of **OFF-RESET/MAN/AUT** keys the desiderated operating modes can be selected and they will appear on the display.

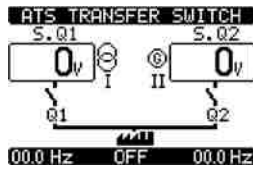

Fig. 2 - OFF/RESET

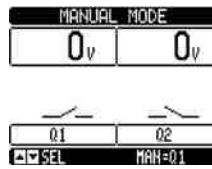

Fig. 3 - MAN

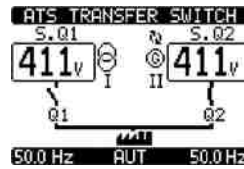

Fig. 4 - AUT

The change of operating mode can be done by pressing the specific button for at least 0.5s. After this time, the new chosen modality will appear another display.

3.1 Reset mode (OFF-RESET)

- In this mode the ATS looks over the lines status but it does not perform any changing actions.
- Lines surveillance, measures display and status LEDs remain active. If the control of the switching devices is impulsive, in OFF mode both open and close commands are disabled. If the command is in continuous mode, the behaviour can be selected by P05.10.
- Pressing the OFF-RESET button it's possible to reset the retentive alarms, after removing alarm conditions.

To access the programming menu is necessary to activate the OFF mode.

3.2 Manual mode (MAN)

- In MAN mode it is possible to manually control the devices. This operation could be done on devices Q1 and Q2 in functions of chosen line (line 1 or line 2). It is possible to select the switch to control by pressing the MAN key. On display the device enabled (Q1 or Q2) appears. By pressing the ▲ or ▼ button it is possible to confirm the closing or opening operation (the command will be received if the button is pushed for at least 300ms).

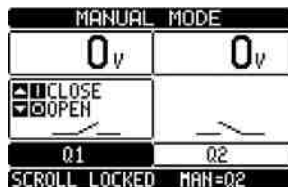

Fig. 5 - Q1 Selection



Fig. 6 - Q1 Closing

- While devices opening-closing is enabled, the page scroll is locked. Pressing MAN several times it is possible to unlock it and to move through other display pages.
- If it is commanded the closing of an opened device while the other one is still closed, the ATS first of all opens the closed device and then it closes the commanded one, interposing the programmed interlock time.

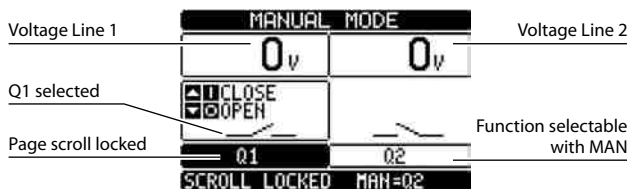

Fig. 7 - Manual mode (MAN)



Fig. 8 - Manual GEN mode

With an application Utility-Generator (U-G) or Generator-Generator (G-G), it is possible to manually control the switching on and off of the generator in a manner similar to that above described, but moving on the page start / stop groups.

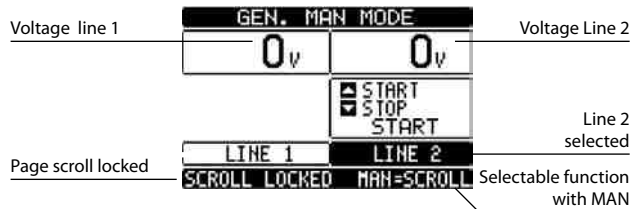

Fig. 9 - Generator manual mode

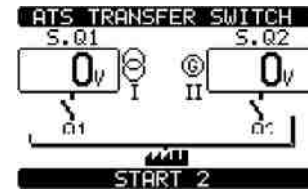

Fig. 10 - Start Generator manual mode

3.3 Automatic mode (AUT)

- In automatic mode, the ATS checks permanently the lines and breakers status. Starting from the state of lines it performs autonomously the closing/opening operations of breakers and the optional startup/shutdown of the generator set.
- When the main line (S.Q1) exceeds the specified limits for a time higher the one set, the green LED C (line presence) switches off giving a "threshold out" alarm. The ATS disconnects the load from S.Q1 and connects it to the S.Q2 (if it is available and within admitted limits). After S.Q1 returns within the specified thresholds, the ATS moves the load on this one after it has checked the stability and the quality of line. One time the changeover is finished, the ATS can provide to the eventual cooling cycle of generator set (if it is programmed).
- Automatic operating cycles vary both as a function of the type of application (Utility-Utility, Utility-Generator, Generator-Generator) and as a function of the type of devices used (motorized circuit breakers or contactors).
- It is possible to program the unit to open the priority line S.Q1 before or after the secondary line S.Q2 has been made available, through parameter P05.05 in the M05 "changeover" menu.
- When the priority line S.Q1 turns within the established limits, the unit opens S.Q2 and switches the load on S.Q1. If on S.Q2 is present a generator, the ATS provided to the eventual cooling cycle of it. It is possible also to lock the automatic return to the priority line S.Q1 setting parameter P05.12. In this case it is necessary an external intervention to authorize the turn of load to line S.Q1.

4. Power-up

- The ATS can be supplied at 100-240VAC.
- After first power-up the device normally starts in OFF/RESET mode.
- During the normal work of ATS, if it switches off, when it will be switched on it comes to operating mode actives before the switching off.
- If it is necessary to modify this behaviour, the parameter P01.03 in the M01 "utilities" menu has to be changed.
- During power-up all the LEDs blink in order to verify their operation.

5. Main menu

- The "main menu" is made up of a group of graphic icons that allow to access to functions. In function of selected icon, a description will be displayed on the display.

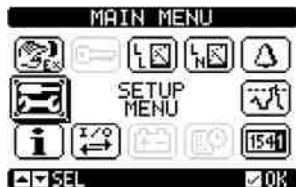

Fig. 11 - Main menu

The main menu allow the rapid access to measurements and settings.

- Starting from main page, press ▲ and ▼ keys together. The menu screen is displayed.
- Press ◀ or ▶ to rotate clockwise/counter clockwise to select the required function. The selected icon is highlighted and the central part of the display shows the description of the function.
- Press (AUT) ✓OK to activate the selected function.
- If some functions are not available, the correspondent icon will be disabled (shown with light grey colour).
- Icons descriptions:

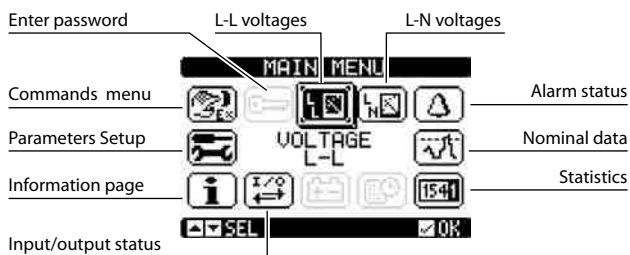











Fig. 12 - Main menu

-  – Settings and access to the password inserction.
-  – View of L-L voltages.
-  – View of L-N voltages.
-  – View of alarm status.
-  – Nominal data.
-  – Statistic data of the ATS operation.
-  – Input/output status.
-  – Information page.
-  – Setup menu for parameter programming (see dedicated chapter).
-  – "Commands menu" (see dedicated chapter).

6. Password access



The ATS has a password function that at first switching on is not active in order to access to all parameters (M03 Password OFF).

N.B. In case of password activation/modify, it is recommended to make a copy of it to guarantee future access with desired privileges.

- It is possible to define different level of password in order to permit different access to "settings/commands" menu in function of access privileges.
- If password is activated, in order to enter to protected data, it is necessary to insert the correct code.
- To enable password management and to define numeric codes, see M03 "password" menu.
- There are different access levels:
 - **Password disabled (OFF)**– The password is disabled. Complete access to all parameters (Default Legrand).
 - **Password enabled (ON)** – The password is enabled:
 - **Access without to insert password (Lev.1)** The password is enabled but not inserted. This access allow the visualization only.
 - **User Level access (Lev.2)** It allows the change of mode, the clearing of recorded values and editing of a limited number of setup parameters.
 - **Advance Level access (Lev.3)** Complete access to all parameters.

MENU	Password OFF			
		Password ON (liv2-liv.3)		
		NO Password Lev 1	Lev. 2	Lev. 3
M01	•	X	•	•
M02	•	X	X	•
M03	•	X	X	•
M04	•	X	X	•
M05	•	X	•	•
M06	•	X	•	•
M07	•	X	X	•
M08	•	X	X	•
M09	•	X	X	•

- The default password for each level are the followings:

Password mode	Password OFF default Legrand	Full Access	
	Password ON	Level	Password
		1	-
2		1000	
3	2000		

- From normal viewing, press ✓ to recall main menu, select the password icon and press ✓.
- The display shows the screen below:



Fig. 13 - Enter password



Fig. 14 - Enter password level Ok



Fig. 15 - Enter Wrong password level

- With keys ▲ and ▼ it is possible to change the selected digit.
- With keys +◀ and ▶- it is possible move through the digits.



ATTENTION! To confirm the password it is mandatory to select  icon and to confirm with ✓ OK. If the code is confirmed with OK without going on key icon , the value won't be accepted.

- In function of level password "Level 2-User or Level 3-Advanced" the correspondent unlock message is shown.
- Once unlocked the password, the access rights are valid until one of the followings conditions are verified:
 - A timeout period of two minutes elapses without any keystroke.
 - The device is reset (after quitting the setup menu).
 - The device is turned off.
- To quit the password entry screen press ✓ key.

7. Display pages

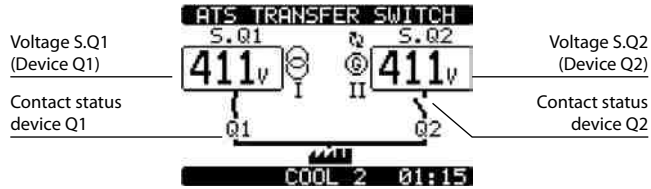

Fig. 16 - Synoptic

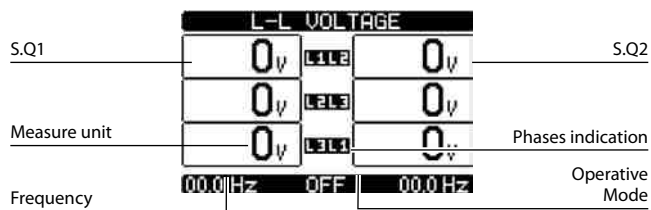

Fig. 17 - L-L voltage

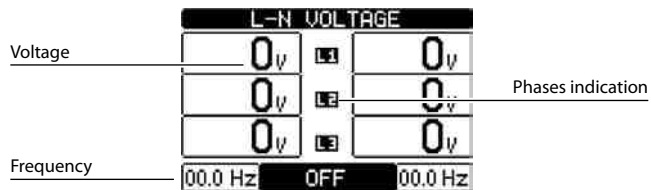

Fig. 18 - L-N voltage

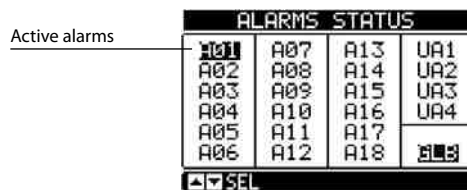

Fig. 19 - Alarms status



Fig. 20 - Control Thresholds

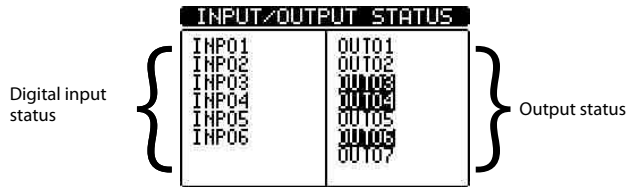

Fig. 21 - Input/Output status

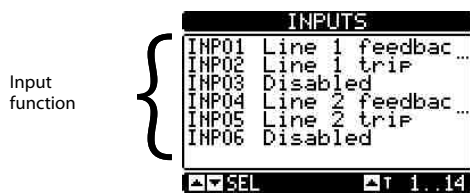

Fig. 22 - Inputs

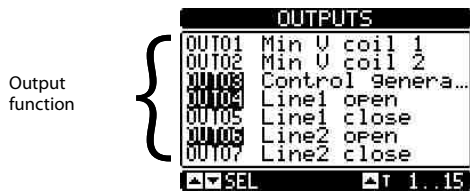

Fig. 23 - Outputs

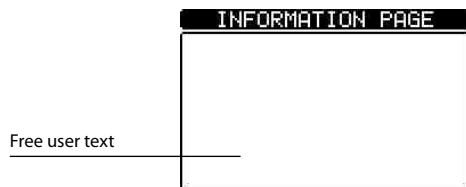

Fig. 24 - Information page



Fig. 25 - System info

- **Note:** some of the pages listed above may not be displayed if the relevant function is disabled. For example, if the limit threshold function is not programmed, the concerning page will not be shown.

8. Communication

- The inputs and outputs are identified by a code and a sequence number. Example: the digital inputs are identified by code INPx, where x is the number of the input. In the same way, digital outputs are identified by code OUTx.

CODE	DESCRIPTION	BASE
INPx	Digital Inputs	1...6
OUTx	Digital outputs	1...7

- Internal variables (bit) are associated to inputs/outputs. For instance, it is possible to apply limit thresholds to the measurements done by the ATS. In this case, an internal variable named LIMx will be activated when the measurements will go outside the limits defined by the user.
- The following table shows all the I/Os and the internal variables managed by the automatic transfer switch with highlighting of their range (variables number per type).

CODE	DESCRIPTION	RANGE
LIMx	Limit thresholds	1...4
REMx	Remote-controlled variables	1...16
UAx	User alarms	1...4
CNTx	Programmable counters	1...4

- Functions associated to the inputs are the 4 described in the above table.
- LIMx**: internal variable that identifies a limit value set by the user and managed by the ATS. Its status (active or not) depends by out-of-limits of one measurement set by the user.
- CNTx**: internal counters that can count pulses coming from an external source (through a digital input INPx) or the times that a certain condition has been verified.
Example: defining a limit threshold LIMx as count source, it will be possible to count how many times one measurement has exceeded a certain limit.
- REMx**: allow the managing of remote variables.
- UAx**: allow the activation and managing of 4 programmable alarms.

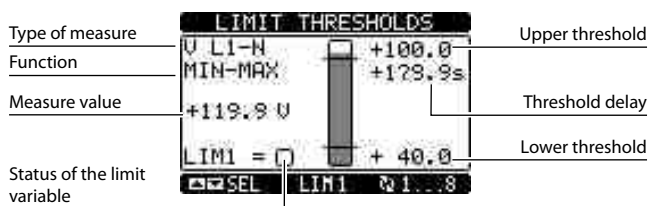

Fig. 26 - Limit thresholds

8.1 User Alarms (UAx)

- User can set a maximum of 4 programmable alarms (UA1...UA4).
- Conditions that generates the alarm can be different:
 - In association of one thresholds LIMX set
 - Activation of digital inputs INPx.
- For each alarm, the user can define a message that will appear on the alarm page.
- Properties of alarms can be defined by the user in the same way that normal alarms.
- When several alarms are activated at the same time, they are displayed sequentially, and their total number is shown on the status bar.
- To reset one alarm that has been programmed with latch, use the dedicated command in the "commands" menu.

8.2 Counters (CNTx)

- This function allows, by selecting a control channel, to activate a counter (see chapter M14 "counters").
- It is possible to count:
 - Impulses acquired from inputs INPx;
 - The numbers of activations of outputs OUTx;
 - The overcome of limits LIMx;
 - Activation of known variables.
- The description of counters CNTx can be customized with a test of maximum 16 characters.
- The unit of measure of counters Umn can be customized with a test of maximum 6 characters.

9. Keypad lock

- The automatic transfer switch keypad can be locked, avoiding not desired command.
- Once the keypad is locked, it will only be possible to view measures, but not to change operating mode or to operate in MAN mode on devices. If the icon menu is shown and the keypad is locked, wait 2 minutes to return to main page.

N.B. Any attempt to use the locked keys will cause the word “ACCESS LOCKED” to be displayed.

- The activation of keypad lock can be made in the followings ways:
 - With a programmable input (activate the function “keypad lock”);
 - From frontal keys;
 - With SW ACU.
- To lock or unlock the keypad, press key ▲ and, while holding it down, press key ▼ three times without releasing it at the end. Release then key ▲ and then press it 5 times, then release both keys.
- When the keypad is locked, the display shows the word “KEYBOARD LOCKED”. If the keypad isn’t locked the display shows the word “KEYBOARD UNLOCKED”.

10. Programmation

10.1 Parameter setting (setup) from frontal panel

- To access to “parameters” menu and to modify them, it is necessary put the ATS in OFF mode, recall the “main” menu (press ▲ ▼ simultaneously), select the “setup” menu () and confirm with (✓OK).

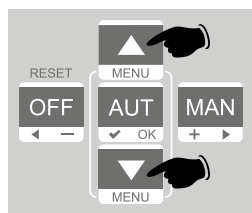

Fig. 27

0,3 sec.



Fig. 28

- A table shown in the following picture is displayed.



Fig. 29 - Setup menu

- Sliding menu Mxx it is possible to select sub-menus where are present all parameters associated to the function.
- Select the required menu with keys ▲ or ▼ and confirm with •.
- Press OFF to quit and return to the measurement viewing.

N.B. If the icon is not enabled (in grey color), it is necessary to check access privileges to modify parameters (see chapter “passwords”).

10. Programming

10.2 Parameter setting (setup) with PC

- The managing of setting parameters can be done also using the PC Software "ACU configurator" (available to free download on E-catalogue Legrand).
- Using software ACU it is possible to transfer set-up parameters from ATS to PC, generating a file. It is also possible to transfer to ATS a file with parameters from SW ACU.
- It is possible to transfer parameters in 2 ways:
 - Total transfer: all parameters are uploaded on ATS in one time
 - Partial transfer: only menu with modified data will be uploaded to the ATS
- The PC can be used also to define "information page" where to add informations, characteristics, data etc...concerning the application.

For more details refers to manual of Software ACU configurator.



Fig. 30 - Setup menu

10. Programming

10.3 Parameter setting with smartphone or tablet

- The managing of setting parameters can be done also using the App for smartphone and tablet "ACU configurator" (available to free download on Google Play and Apple iStore).
- The connection between ATS and App is possible by means of WiFi dongle (Legrand).
- The App permits to see alarms, to send commands, to read measures, to set parameters, to download events.



Fig. 31 - App

10.4 IR port

- The parameters of the automatic transfer switch can be configured and consulted also through the front optical port, using a USB or WiFi dongle.
- Using this port it is possible to configure and to dialogue with the automatic transfer switch without the need to access to the rear of the device or having to open the electrical panel. This connection is isolated from internal circuit ensuring safety for the operator.
- This port guarantees IP40 front protection.
- Simply holding the USB/WiFi dongle up to the front panel, connecting the plugs to the connectors the device will be connected. The recognition between devices will be shown by the green "LINK" LED on the programming dongle.



Fig. 32 - WiFi Dongle

11. Menu

The following table lists shows the available ATS menus:

CODE	MENU	DESCRIPTION
M01	UTILITY	Language, brightness, display pages, etc.
M02	GENERAL	System nominal data
M03	PASSWORD	Password settings
M04	CHANGEOVER	Load changeover settings
M05	LINE 1 CONTROL	Valid limits for voltage line1 (S.Q1)
M06	LINE 2 CONTROL	Valid limits for voltage line 2 (S.Q2)
M07	DIGITAL INPUTS	Programmable digital inputs functions
M08	DIGITAL OUTPUTS	Programmable digital outputs functions
M09	ALARM TABLE	Alarms effect enabling

- The access to the menu/sub-menu modify page is subject to the input of password (if the function is activated).
- After highlighted the correct menu it is necessary press ✓ to show the parameters.
- Each parameter is shown with code, description and actual setting value.

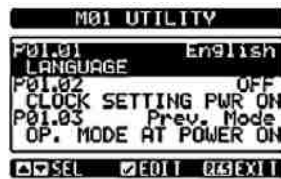

Fig. 33 - Set-up: parameter selection

- To modify the setting of one parameter, select it and then press ✓.



Fig. 34 - Set-up: editing page

- The parameter setting can be modified with +► and -◀ keys. The screen shows the new setting, a graphic bar with the setting range, the maximum and minimum values, the previous setting and the factory default.
- Pressing +► and ▲ the value is set to the maximum admitted, while with ▲ and -◀ it is set to the minimum.
N.B. Pressing simultaneously +► and -◀, the setting is set to factory default.
During the typing of a text string, keys ▲ and ▼ are used to select the alphanumeric character while +► and -◀ are used to move the cursor along the text string.
N.B. Pressing keys ▲ and ▼ simultaneously will move the character selection straight to character "A".
- Press ✓ to go back to the parameter selection. The entered value is saved.
- Press OFF to save all the settings and to quit the setup menu. The controller executes a reset and returns to normal operation.
- In "SET-UP" mode, if the user does not press any key for at least 2 minutes, the system leaves automatically and goes back to normal viewing without saving the changes done on parameters.

12. Parameters

- In menu “parameters” are described all parameters, their changes and it is defined the work mode of ATS. Menu is composed by 9 parts.
 - Each menu is composed by specific parameters Px that can be modified in function of needs.
 - For example, the definition of control characteristics of power sources can be defined by the customer using parameters of M05 “load changeover” menu and M06-M07 “voltage control line 1S.Q1 -voltage control line 2 S.Q2” menus.
 - With menus M06 and M07 it is possible to set nominal data for power sources such as nominal voltage, nominal frequency that could be used to set thresholds.
 - It is possible set a transformation ratio TV associated to the control inputs establishing criteria in M02 “general” menu. In case a lower voltage is applied but proportional to that of plant, limits of measures will be real values of plant.
 - The ATS can be set to do voltage checks in three-phases lines with or without neutral, bi-phases or single-phase (P02.07).
 - In case of lines three-phases or bi-phases it is possible to choose if monitor/control phase-phase voltage or phase-neutral voltage or both. (P02.06).
- N.B. Nominal voltage set with P02.01 must be referred to phase-phase voltage.**
- In the followings tables are listed controls that could be done on each line.

12.1 Description of “utility” menu

M01 – UTILITY		UoM	DEFAULT	RANGE
P01.01	Language		English	English French Spanish Russian Polish
P01.02	Power-on operating mode		Previous	OFF mode Previous
P01.03	LCD contrast	%	50	0-100
P01.04	Display backlight intensity high	%	100	0-100
P01.05	Display backlight intensity low	%	25	0-50
P01.06	Time to switch to low backlighting	s	180	5-600
P01.07	Return to default page	s	300	OFF / 10-600
P01.08	Default page		Synoptic	(page list)
P01.09	Plant identifier		(empty)	String 20 chr.

- **P01.01** – Select display text language.
- **P01.02** – Start system in OFF mode after power-up or in same mode it was switched off in.
- **P01.03** – Adjust LCD contrast.
- **P01.04** – Display backlight high adjustment.
- **P01.05** – Display backlight low delay.
- **P01.06** – Select the delay for the display backlight to switch from high to low
- **P01.07** – Default page display restore delay when no key pressed. If set to OFF the display will always show the last page selected manually.
- **P01.08** – Default page displayed on power-up and after delay.
- **P01.09** – Free text with alphanumeric identifier name of specific plant.

12.2 Description of “general” menu

M02 - GENERAL		UoM	DEFAULT	RANGE
P02.01	Nominal plant voltage	VAC	400	50-50000
P02.02	Phase sequence control		OFF	OFF L1-L2-L3 L3-L2-L1
P02.03	Wiring mode		L1-L2-L3	L1-L2-L3-N L1-L2-L3 L1-N-L2 L1-N
P02.04	Voltage control mode		L-L	L-L L-N L-L + L-N
P02.05	Nominal frequency		50HZ	50 HZ 60 HZ

- **P02.01** – Rated voltage of grid and generator. Set the line-to-line voltage for polyphase systems.
- **P02.02** – Enable phase sequence control. **OFF** = no control. **Direct** = L1-L2-L3. **Reverse** = L3-L2-L1.
N.B. Enable also corresponding alarms in case of a control parameter won't be respected.
- **P02.03** – Choosing the type of connection, three-phase with/without neutral, two-phase or single phase.
- **P02.04** – Voltage checks performed on concatenated, phase voltages or both.
- **P02.05** – Rated frequency S.Q1/S.Q2

12.3 Description of “password” menu

M03 - PASSWORD		DEFAULT	RANGE
P03.01	Password enable	OFF	OFF-ON
P03.02	User level password	1000	0000÷9999
P03.03	Advanced level password	2000	0000÷9999

- **P03.01** – If set to OFF, password management is disabled and anyone has access to the settings and commands menu.
- **P03.02** – With P03.01 enabled, levels password are enabled. It is necessary insert the correct value to activate the access to user level (the password can be modified by customer). See “*Password access chapter*”.
- **P03.03** – As for P03.02, with reference to advanced level access.

12. Parameters

12.4 Description of "Load changeover" menu

In the following menu are present mains parameters to identify the correct plant configuration and to define characteristics to manage and to check the changeover system.

M05 – LOAD CHANGEOVER		UoM	DEFAULT	RANGE
P05.01	Application type		U-G	U-G U-U G-G
P05.02	Priority line selection		-1-	-1- Line 1 -2- Line 2
P05.03	Line 1 → Line 2 interlock time	s	6.0	0.1...1800.0
P05.04	Line 1 ← Line 2 interlock time	s	6.0	0.1...1800.0
P05.05	Breaker open mode		OBP	OBP OAP
P05.06	Maximum operating switch time (A03 – A04 alarms delay)	s	5	1...900
P05.07	Changeover type		Brk. Pul.	Brk. Pul. Brk. Con. Chg. Pul. Chg. Con. Contactors
P05.08	Opening pulse duration	s	10	0-600
P05.09	Closing pulse duration	s	1	0-600
P05.10	Continuous command in RESET/OFF mode		NOC	OFF NOC
P05.11	Load no powered maximum time (A07 delay time)	s	60	OFF / 1...3600
P05.12	Inhibition automatic return on priority LINE		OFF	OFF / ON
P05.13	Changeover on closing failure (only with open feedback)		OFF	OFF 1 2 1+2
P05.14	Minimum voltage coil pulse duration	s	1.0	0.1 ... 10.0
P05.15	Delay between minimum coil and spring reload	s	0.2	0.1 ... 10.0
P05.16	Closing retry		OFF	OFF AUT AUT+MAN

- **P05.01** – It defines the type of application
U-G = Utility to Generator
U-U = Utility to Utility
G-G = Generator to Generator
- **P05.02** – It defines which is the main line that is the line taking on the load when both sources are available.
- **P05.03** – Time from the opening of the Q1 device, after which the Q2 device closing command is given.
- **P05.04** – Time from the opening of the Q2 device, after which the Q1 device closing command is given.
- **P05.05** – **OBP** (Open Before Presence) means that, in automatic mode, the open command of a device is generated when the line concerned goes beyond limits, irrespective of the status of the alternative line.
OAP (Open After Presence) means that, in automatic mode, the open command of a device is sent only after the alternative line is present within limits.

- **P05.06** – If, after sending an open or close command to a circuit breaker, this is not positioned correctly within this time (feedback by means of OC contacts), alarms A03 or A04 are generated.
- **P05.07** – It defines whether open-close outputs must be continuously active (application with contactors or circuit breakers) or in pulse mode, i.e. activated until the device has been positioned as required. If in pulse mode, the command is extended for a specified time (see P5.08 e P5.09) even after positioning completion.
- **P05.08** – Minimum duration of an opening command pulse. For the motorized circuit breaker application, it must be set to a time long enough to allow the load of the springs. This time is considered also when working in continuous mode.
- **P05.09** – Duration of the closing command pulse.
- **P05.10** – It defines the behaviour of the open/close command outputs when working in continuous command mode and the automatic transfer switch is in RESET/OFF mode. This parameter can be useful when working with contactors.
OFF – It opens the command outputs
NOC – No change on command output
- **P05.11** – If in automatic mode both sources are not available at the same time for a time exceeding P5.11, alarm A07 is generated.
- **P05.12** – If this parameter is enabled, after a transfer to the S.Q2, restoring to S.Q1 does not occur automatically when the latter becomes available again, but it must be commanded in manual mode.
OFF – Disabled
ON – Enabled
- **P05.13** – If enabled, in case of closing failure of the switching device, in addition to the generation of the proper feedback alarm (A03 or A04) the load is switched to the alternative source.
OFF = function disabled.
1 = check source S.Q1.
2 = check source S.Q2.
1+2 = check both S.Q1 and S.Q2.
- **P05.14** – In case of using of UVR in the changeover system controlled by ATS (parameter “UVR command” into menu M11 “programmable outputs”) this parameter defines the period of deactivation of them to assure the immediate opening of devices)
- **P05.15** – Time between the opening pulse on the minimum voltage coil and the spring reload command.
- **P05.16** – In case of use of motorized breakers, this parameter defines in which operating mode the automatic transfer switch must execute the closing retry cycle. The closing retry is executed in case the breaker fails to close because the springs were not loaded. It consists of a complete opening and spring loading cycle, followed by the issuing of a new closing command. If the breaker fails to close again, then the A03 or A04 feedback alarm are generated.

12. Parameters

12.5 Description of "Voltage control line 1 S.Q1" menu

In this paragraph control parameters, thresholds setting and control levels of power sources defining acceptability criteria are described. In this menu is also possible set the insensibility level to micro interruptions using parameter P06.10 (standard value 100ms). This could be extended until 30s in case of disturbed lines.

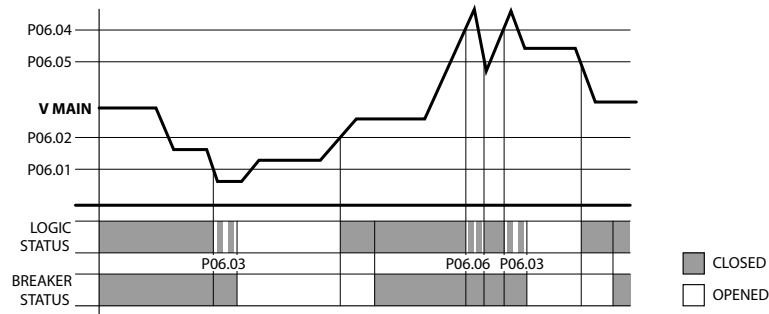

Fig. 35



N.B. the insensibility to interruption is for default 100ms. With parameter P06.10 this time could be modify until 30s.

M06 – VOLTAGE CONTROL LINE 1 S.Q1		UoM	DEFAULT	RANGE
P06.01	MIN voltage limit for trip	%	85	70-100
P06.02	MIN voltage restore	%	90	70-100
P06.03	MIN voltage delay	s	5	0-600
P06.04	MAX voltage limit for trip	%	115	100-130 / OFF
P06.05	MAX voltage restore	%	110	100-130 / OFF
P06.06	MAX voltage delay	s	5	0-600
P06.07	Return of power in the limits delayed (when S.Q2 source not available)	s	10	1-6000
P06.08	Return of power in the limits delayed (when S.Q2 source available)	s	60	1-6000
P06.09	Phase failure threshold	%	70	60% - 80% OFF
P06.10	Phase failure delay	s	0.1	0.1s-30s
P06.11	MAX Asymmetry limit	%	15	1% -20%/OFF
P06.12	MAX Asymmetry delay	s	5	0.1-900
P06.13	MAX frequency limit	%	105	100-120/OFF
P06.14	MAX frequency delay	s	3	0-600
P06.15	MIN frequency limit	%	95	OFF/80-100
P06.16	MIN frequency delay	s	5	0-600
P06.17	S.Q1 control OFF mode		OFF	OFF ON OFF+GLOB ON+GLOB
P06.18	S.Q1 control MAN mode		OFF	OFF ON OFF+GLOB ON+GLOB
P06.19	Time delay generator starter due to a lack of S.Q1	s	OFF	OFF / 1-6000
P06.20	Generator cooling time	s	120	1-3600

- **P06.01 - P06.02 - P06.03** – The first two parameters define the minimum voltage threshold and the related hysteresis upon restore. P06.02 cannot be set to a lower value than P6.01. P6.03 defines the intervention delay of this protection.
- **P06.04 - P06.05 - P06.06** – The first two parameters define the maximum voltage threshold and the related hysteresis upon restore. P06.05 cannot be set to a value exceeding P06.04. Setting P06.04 to OFF will disable the maximum voltage control. P06.06 defines the maximum voltage intervention delay.
- **P06.07** – Delay for S.Q1 (Line 1) restores to the limit range, used when the line 2 (S.Q2) source is not available. Generally shorter than P06.08, as there is the urgent need to supply power because the load is not energized.
- **P06.08** – Delay for S.Q1 (Line 1) restores to the limit range, used when the load can be connected to S.Q2 (line 2). Generally longer than P06.07, as the load is energized and consequently it is possible to wait longer before considering voltage steadily restored.
- **P06.09 - P06.10** – Voltage threshold below which a phase loss intervention occurs, generally quicker than the drop. The delay for the phase loss is specified by P06.10. This parameter has to be evaluate in function of load (example: damaging of engines in case of phase missing).
- **P06.11 - P06.12** – P06.11 defines the maximum threshold for unbalance between phases, referred to voltage rating, and P06.12 defines the related intervention delay. This control may be disabled by setting P06.11 to OFF.
- **P06.13** – Max. frequency intervention threshold (it can be disabled).
- **P06.14** – Max. frequency intervention delay.
- **P06.15** – Min. frequency intervention threshold (it can be disabled).
- **P06.16** – Min. frequency intervention delay
- **P06.17** – Parameters and described characteristics are referred to ATS in AUT mode.
OFF = S.Q1 (line 1) voltage control in OFF mode disabled.
ON = Voltage control in OFF mode enabled.
OFF+GBL = Voltage control in OFF mode disabled, but the relay programmed with the global alarm function activates or not depending on whether the voltage is respectively absent or present.
ON+GBL = Voltage control in OFF mode enabled, and the relay programmed with the global alarm function activates or not depending on whether the voltage is respectively absent or present.
- **P06.18** – Parameters and described characteristics are referred to ATS in MAN mode.
OFF = S.Q1 (line 1) voltage control in OFF mode disabled.
ON = Voltage control in OFF mode enabled.
OFF+GBL = Voltage control in OFF mode disabled, but the relay programmed with the global alarm function activates or not depending on whether the voltage is respectively absent or present.
ON+GBL = Voltage control in OFF mode enabled, and the relay programmed with the global alarm function activates or not depending on whether the voltage is respectively absent or present.
- **P06.19** – Engine start delay when S.Q1 (line 1) fails to meet set limits. If set to OFF, the starting cycle starts when the mains contactor opens.
- **P06.20** – Max. duration of the cooling cycle. Example: time between load disconnection from the generator and when the engine actually stops.

continues...

12. Parameters

12.6 Description of "Voltage control line 2 S.Q2" menu

M07 – VOLTAGE CONTROL LINE 2 S.Q2		UDM	DEFAULT	RANGE
P07.01	MIN voltage limit for trip	%	85	70-100
P07.02	MIN voltage restore	%	90	70-100
P07.03	MIN voltage delay	s	5	0-600
P07.04	MAX voltage limit for trip	%	115	100-130 / OFF
P07.05	MAX voltage restore	%	110	100-130 / OFF
P07.06	MAX voltage delay	s	5	0-600
P07.07	Return of power in the limits delayed (when S.Q1 source not available)	s	10	1-6000
P07.08	Return of power in the limits delayed (when S.Q1 source available)	s	60	1-6000
P07.09	Phase failure threshold	%	70	60 - 80 OFF
P07.10	Phase failure delay	s	0.1	0.1s-30s
P07.11	MAX Asymmetry limit	%	15	1 - 20 OFF
P07.12	MAX Asymmetry delay	s	5	0.1-900
P07.13	MAX frequency limit	%	105	100-120 OFF
P07.14	MAX frequency delay	s	3	0-600
P07.15	MIN frequency limit	%	95	OFF 80-100
P07.16	MIN frequency delay	s	5	0-600
P07.17	S.Q2 control OFF mode		OFF	OFF ON OFF+GLOB ON+GLOB
P07.18	S.Q2 control MAN mode		OFF	OFF ON OFF+GLOB ON+GLOB
P07.19	Time delay generator starter due to a lack of S.Q2	s	OFF	OFF / 1-6000
P07.20	Generator cooling time	s	120	1-3600

Note: For details on the functions of parameters see the menu M06 – "voltage control S.Q1 (line 1)".

12.7 Description of "Programmable inputs" menu

M10 – PROGRAMMABLE INPUTS (INPn, n=1...14)		UoM	DEFAULT	RANGE
P10.n.01	INPn input function		(various)	(see Input functions table)
P10.n.02	Function index (x)		OFF	OFF / 1...99
P10.n.03	Contact type		NO	NO/NC
P10.n.04	Closing delay	s	0.05	0.00-600.00
P10.n.05	Opening delay	s	0.05	0.00-600.00

Note: his menu is divided into 14 sections that refer to 6 possible digital inputs INP1...INP6, which can be managed by the ATS.

- **P10.n.01** – It selects the functions of the chosen input (see "programmable inputs functions table").
- **P10.n.02** – Index associated with the function programmed in the previous parameter P10.01 ("input function selection").
- **P10.n.03** – Select type of contact: NO (Normally Open) or NC (Normally Closed).
- **P10.n.04** – Contact closing delay for selected input.
- **P10.n.05** – Contact opening delay for selected input.

12.8 Description of "Programmable outputs" menu

M11 – PROGRAMMABLE OUTPUTS (OUT1...15)		UDM	DEFAULT	RANGE
P11.n.01	Output function OUTn		(various)	(see Output functions table)
P11.n.02	Function index (x)		1	OFF / 1...99
P11.n.03	Normal/reverse output		NOR	NOR / REV

Note: This menu is divided into 15 sections that refer to 7 possible digital outputs OUT1... OUT7 managed by the ATS.

- **P11.n.01** – It selects the functions of the selected output (see "programmable outputs functions" table).
- **P11.n.02** – Index associated with the function programmed in the previous parameter P11.01 ("output function selection").
Example: If the output function is set to "Alarm Axx", and it's needed to energize this output for alarm A16, then P11.n.02 should be set to value 16.
- **P11.n.03** – It sets the state of the output when the function associated with the same is inactive: **NOR** = output de-energized, **REV** = output energized.



The configuration installed on ATS by Legrand ensures the correct work if standard wiring diagrams supplied are respected. **WARNING:** the modify of parameters could generate incompatibility with supplied wiring diagrams. It is recommended to not modify the original configuration.

Using expansion modules is possible to increase the amount of outputs available in order to do additional checks and controls (this solution is recommended to avoid the change of work mode of outputs in case of specific applications).

12. Parameters

12.9 Description of “Alarms” menu

- When an alarm is generated, the display will show an alarm icon, the code and the description of the alarm in the language selected.



Fig. 36

- If the navigation keys in the pages are pressed, the pop-up window showing the alarm indications will disappear momentarily, to reappear again after a few seconds.
- The red LED near the alarm icon on the front panel will flash when an alarm is active. In the area of synoptic on the display remains a flashing icon that represents the type of the alarm.
- Alarms can be reset by pressing the key OFF.
- If the alarm cannot be reset, the problem that generated the alarm must be solved.
- In the case of one or more alarms, the behaviour of the automatic transfer switch depends on the properties settings of the active alarms.

12.10 Alarm properties

The ATS has the possibility to manage and generate different types of user alarms (*User Alarms*, Uax) and for each one can be associated different properties:

- **Alarm enabled** – General enabling of the alarm. If the alarm isn't enabled, it's like if it doesn't exist.
- **Only AUT** – The alarm can be generated only when automatic transfer switch is in AUT operating mode.
- **Retained alarm** – It remains in the memory even if the cause of the alarm has been eliminated.
- **Global alarm** – It activates the output assigned to this function.
- **Q1 Locked** – When the alarm is active, no commands are sent to Q1.
- **Q2 Locked** – Like previous property, referred to Q2.
- **Siren** – It activates the output assigned to this function, as configured in the alarm table.
- **Inhibition** – The alarm can be temporarily disabled by activating an input that can be programmed with the Inhibit alarms function.
- **No LCD** – The alarm is normally managed, but not shown on the display. This property is associated only if the alarm is not retenitive.

12.11 Alarm table

CODE	DESCRIPTION	ENABLED	ONLY AUT	RETAINED	GLOB. AL.	LOCK Q1	LOCK Q2	SIREN	INHIBIT.	NO LCD
A01	Timeout Q1 (line 1)	•	•	•	•	•		•		
A02	Timeout Q2 (line 2)	•	•	•	•		•	•		
A03	S.Q1 (line 1) wrong phase sequence	•		•	•			•		
A04	S.Q2 (line 2) wrong phase sequence	•		•	•			•		
A05	Timeout load not powered	•	•		•			•		
A06	Emergency	•		•	•			•		
A07	Protection intervention Q1 (line 1) (trip)	•		•	•	•	•	•		
A08	Protection intervention Q2 (line 2) (trip)	•		•	•	•	•	•		
A09	Q1 (line 1) generator not available	•			•			•		
A10	Q2 (line 2) generator not available	•			•			•		
A11	Auxiliary voltage failure	•			•			•		

12. Parameters

12.12 Alarm description

CODE	DESCRIPTION	ALARM EXPLANATION
A01	Q1 (Line 1) timeout	The Q1 changeover device did not perform the opening or closing operation within the max. time set. After alarm A03 generation, the opening or closing command is inhibited. Alarms are generated only if at least one of the two power sources S.Q1 or S.Q2 are present.
A02	Q2 (Line 2) timeout	The Q2 changeover device did not perform the opening or closing operation within the max. time set. After alarm A04 generation, the opening or closing command is inhibited. Alarms are generated only if at least one of the two power sources S.Q1 or S.Q2 are present.
A03	S.Q1 (Line 1) wrong phase sequence	The phase sequence recorded on S.Q1 (line 1) does not correspond to the one programmed.
A04	S.Q2 (Line 2) wrong phase sequence	The phase sequence recorded on S.Q2 (line 2) does not correspond to the one programmed.
A05	Load not powered timeout	The load has been without power for a time longer than the maximum specified with P05.11, either because both source lines (S.Q1 and S.Q2) were absent or because both Q1 and Q2 remained open.
A06	Emergency	Alarm generated by the opening of the external input with Emergency function. Both Q1 and Q2 will be opened.
A07	Intervention for protection CTR Q1	Q1 (Line 1) has tripped because of a plant protection (contact CTR), signalled by activation of the input with function Line 1 breaker protection trip.
A08	Intervention for protection CTR Q2	Q2 (Line 2) has tripped because of a plant protection (contact CTR), signalled by activation of the input with function Line 2 breaker protection trip.
A09	S.Q1 Line 1 generator not available	Alarm generated by the input Generator S.Q1 (Line 1) ready.
A10	S.Q2 Line 2 generator not available	Alarm generated by the input Generator S.Q2 (Line 2) ready.
A11	Maintenance operations S.Q1	Alarm generated when the number of operations for S.Q1 reach the value sated in the menu M12. Use the menu commands to restore the function and to reset the alarm.
A12	Maintenance operations S.Q2	Alarm generated when the number of operations for S.Q2 reach the value sated in the menu M12. Use the menu commands to restore the function and to reset the alarm.

13. Function I/O

13.1 Programmable inputs function table

- The following table shows all the functions that can be attributed to the INPn programmables digital inputs.
- Each input can be set for an reverse function (NA – NC), delayed energizing or de-energizing at independently set times.
- Some functions require another numeric parameter, defined in the index (x) specified by parameter **P10.n.02**.
- See menu "M10 Programmable inputs" for more details.



The configuration installed on ATS by Legrand ensures the correct work if standard wiring diagrams supplied are respected. **WARNING:** the modify of parameters could generate incompatibility with supplied wiring diagrams. It is recommended to not modify the original configuration.

Using expansion modules is possible to increase the amount of inputs available in order to do additional checks and controls (this solution is recommended to avoid the change of work mode of inputs in case of specific applications).

FUNCTION	DESCRIPTION
Disabled	Input disabled
Configurable	Free user configuration
Q1 closed (Feedback 1)	Auxiliary contact informing the automatic transfer switch of the open/closed status of Q1 contact OC line 1. Wiring mandatory.
Q2 closed (Feedback 2)	Auxiliary contact informing the automatic transfer switch of the open/closed status of Q2 contact OC line 2. Wiring mandatory.
Q1 protection (Trip 1)	When the contact is closed, it informs the ATS of trip status (CTR). It generates an alarm for Q1 intervention.
Q2 protection (Trip 2)	When the contact is closed, it informs the ATS of trip status (CTR). It generates an alarm for Q2 intervention.
Transfer to secondary line (remote start on-load)	When closed, it causes changeover to secondary line even if main line voltage is within limits. It could be used to change priority between S.Q1 and S.Q2. The secondary line circuit breaker remains activated until this line remains within limits. It can be used for EJP function.
Inhibit Return to main line S.Q1	In AUT mode, when closed, it inhibits the return to main line after it has reverted to the limit range. It is used to prevent the second power cut out due to re-transfer from occurring automatically at an unforeseeable time.
Start Generator	In AUT mode, when closed, it causes the generator to start after the delay specified by P05.14. It can be used for EJP function
Voluntary open	NC contact which, if open, it causes both circuit Q1 and Q2 open and it generates alarm A09.
Generator ready S.Q1	When closed it signals that the generator connected to line 1 is available for use. If this signal is missing, alarm A12 is generated
Generator ready S.Q2	When closed it signals that the generator connected to line 2 is available for use. If this signal is missing, alarm A13 is generated
External S.Q1 control	Line 1 voltage control signal from external device. Enabled, it indicates the voltage is within the limits

13. Function I/O

13.2 Output function table



The configuration installed on ATS by Legrand, ensures the correct work if standard wiring diagrams supplied are respected.

WARNING: the modify of parameters could generate incompatibility with supplied wiring diagrams. It is recommended to not modify the original configuration.

Using expansion modules is possible to increase the amount of outputs available in order to do additional checks and controls (this solution is recommended to avoid the change of work mode of outputs in case of specific applications).

- The following table shows all the functions that can be assigned to the OUTn programmable digital inputs.
- Each output can be configured so it has a normal or reverse (NOR or REV) function.
- Some functions require another numeric parameter, defined in the index (x) specified by parameter **P11.n.02**.
- See menu *M11 Programmable outputs* for more details.

FUNCTION	DESCRIPTION
Disabled	Output disabled
Configurable	User configuration free
Close S.Q1 contactor/ circuit breaker	Command to close Q1
Open S.Q1 circuit breaker	Command to open Q1 and eventual springs charging
Close S.Q2)contactor/ circuit breaker	Command to close Q2
Open S.Q2 circuit breaker	Command to open Q2 and eventual springs charging
Open S.Q/ S.Q2	Open both Q1 and Q2.
UVR Coil S.Q1 (line 1)	It controls the UVR, opening Q1 before the spring load cycle
UVR Coil S.Q2 (line 2)	It controls the UVR, opening Q2 before the spring load cycle
S.Q1 generator control	Start /Stop remote control of S.Q1 generator
S.Q2 generator control	Start /Stop remote control of S.Q2 generator
Automatic transfer switch ready	Automatic transfer switch in automatic mode, without alarms, ready to switch
Global alarm	Output enabled in the presence of any alarm with the Global alarm propriety enabled
S.Q1 status	Output energized when there are all conditions to be able to connect the load to the S.Q1
S.Q2 status	Output energized when there are all conditions to be able to connect the load to the S.Q2
Siren	Activates the contact for the external siren
Operating mode	Output energized when the ATS is in one of the modes set with parameter P12.03
OFF mode	Energized when the automatic transfer switch is OFF
MAN mode	Energized when the automatic transfer switch is in MANUAL mode
AUT mode	Energized when the automatic transfer switch is in AUT mode
REM(x) remote variable	Output controlled by remote variable REMx (x=1..16)
LIM limits (x)	Output controlled by the state of the limit threshold LIM(x) (x=1..4) defined by the index parameter
Dummy load	Output enabled when self-test with dummy load is running.
Load connected to S.Q1	Q1 closed
Load connected to S.Q2	Q2 closed
Alarms A01-Axx	Output energized with alarm Axx is enabled (xx=1...alarms number)
Alarms UA1..Uax	Output energized with alarm Uax is enabled (x=1...4)

FUNCTION	DESCRIPTION
External S.Q2 control	Line 2 voltage control signal from external device. Enabled, it indicates the voltage is within the limits
Enable Load on S.Q1	It allows load connection on S.Q1, in addition to internal controls.
Enable Load on S.Q2	Like previous, referred to S.Q2
Delay 1 bypass	Reset the delay presence on S.Q1
Delay 2 bypass	Reset the delay presence on S.Q2
Keypad lock	If closed, it locks all the functions from front keypad except measure viewing
Lock Parameters	If closed, it locks the access to setup menus
Lock remote control	If closed, it locks write access through serial interface ports
Siren OFF	It disables the siren
Alarms inhibition	If enabled, it disables the alarms that have the property Inhibit alarms activated
Alarms reset	It resets the retained alarms for which the condition that triggered the same has stopped
Key OFF simulation	Closing the input is the equivalent of pressing the key.
Key MAN simulation	Closing the input is the equivalent of pressing the key.
Key AUT simulation	Closing the input is the equivalent of pressing the key.
Automatic test inhibition	It inhibits the automatic test
LED Test	It makes all the LEDS on the front panel flash
Q1 closing	Close the Q1 in manual mode
Q1 opening	Open the Q1 in manual mode
Q1 toggling	Toggle the Q1 in manual mode
Q2 closing	Close the Q2 in manual mode
Q2 opening	Open the Q2 in manual mode
Q2 toggling	Toggle the Q2 in manual mode

14. Installation

- The automatic transfer switch is designed with IP40 protection.
- Insert the device into the panel hole,
- From inside the panel, for each four of the fixing clips, position the clip in its square hole on the housing side, then move it backwards in order to position the hook.



Fig. 37 - Mounting

- Repeat the same operation for the four clips.
- Tighten the fixing screw with a maximum torque of 0,5Nm.
- In case it is necessary to dismantle the system, unloose the screws.
- For the electrical connection see the Legrand wiring diagrams.

15. Terminals position

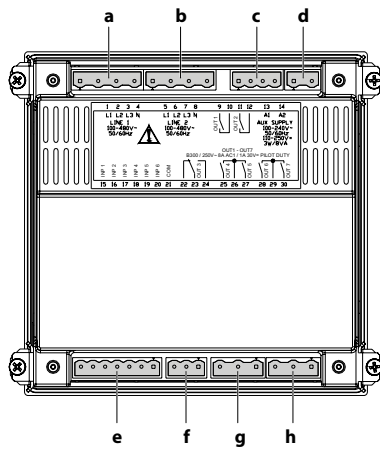

CODE	DESCRIPTION
a	Line 1 voltage control (S Q1)
b	Line 2 voltage control (S Q2)
c	OUT1 - OUT2 - (NO) Programmable relay
d	AUX 240 VAC power supply
e	Programmable inputs (INP xxx)
f	OUT3 NO/NC Programmable relay
g	OUT4 /5 NO/NC Programmable relay
h	OUT6/7 NO/NC Programmable relay

Fig. 38 - Rear view

16. Dimensions

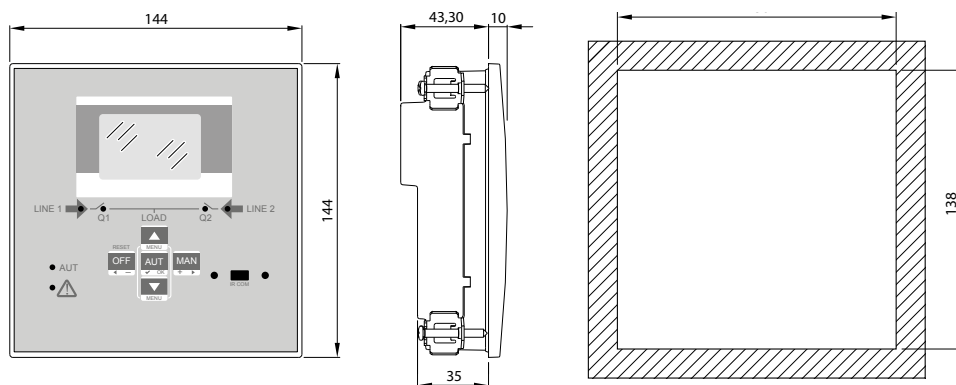

Fig. 39 - Dimensions

17. Technical characteristics

TECHNICAL CHARACTERISTICS	
AC Supply : terminals 13, 14	
Rated voltage U_s	100 - 240VAC 110 - 250VDC
Operating voltage range	90 ÷ 264VAC 93,5 ÷ 300VDC
Frequency	45 - 66Hz
Power consumption/dissipation	3,8W – 9,5VA
Immunity time for microbreakings	≤50ms (110VAC) ≤250ms (220VAC)
	≤25ms (110VAC) ≤120ms (220VAC) } (with expansion module)
Recommended fuses	F1A Type F
Line 1 and Line 2 voltage inputs: terminals 1-4 and 5-8	
Maximum rated voltage U_e	480 Vac L-L (277VAC L-N)
Measuring range	50-576 Vac L-L (333V Vac L-N)
Frequency range	45-65Hz
Measuring method	TRMS
Measuring input impedance	> 0,5MΩ L-N > 1,0MΩ L-L
Wiring mode	Single-phase, two-phase, three-phase with or without neutral or balanced three-phase system.
Measuring accuracy	
Mains and generator voltage	±0,25% f.s. ±1digit
Real time clock	
Energy storage	Back-up capacitors
Operating time without supply voltage	About 5 minutes
Digital inputs: terminals 15 - 20	
Input type	Negative
Current input	≤8mA
Input "low" voltage	≤2,2V
Input "high" voltage	≥3.4V
Input delay	≥50ms
OUT1 and OUT 2 outputs: terminals 9,10 e 11,12	
Contact type	2 x 1 NO
Rated current	AC1 - 8A 250VAC DC1 - 8A 30VDC AC15 -1,5A 250VAC
Max rated voltage	300 Vac
Mechanical / electrical endurance	10 ⁷ / 10 ⁵ ops
OUT3 output: terminals 22, 23, 24	
Contact type	1 changeover
Rated current	AC1 - 8A 250VAC DC1 - 8A 30VDC AC15 -1,5A 250VAC
Max rated voltage	300 Vac
Mechanical / electrical endurance	10 ⁷ / 10 ⁵ ops

TECHNICAL CHARACTERISTICS		
OUT4 and OUT 5 outputs: terminals 25,26,27		
Contact type	2 x 1 NO + Common contact	
Rated current	AC1 - 8A 250Vac DC1 - 8A 30Vdc AC15 -1,5A 250 Vac	
Max rated voltage	300 Vac	
Mechanical / electrical endurance	10 ⁷ / 10 ⁵ ops	
Maximum current at contact common	10A	
OUT6 and OUT 7 outputs: terminals 28,29,30		
Contact type	2 x 1 NO + Common contact	
Rated current	AC1 - 8A 250Vac DC1 - 8A 30Vdc AC15 -1.5A 250Vac	
Max rated voltage	300 Vac	
Mechanical / electrical endurance	10 ⁷ / 10 ⁵ ops	
Maximum current at contact common	10A	
Contact type	2 x 1 NO + common contact	
Insulation voltage		
AC Supply		
Rated insulation voltage	Ui 250Vac	
Rated impulse withstand voltage	Uimp 7.3kV	
Power frequency withstand voltage	3kV	
Line 1 and Line 2 voltage inputs		
Rated insulation voltage	Ui 480Vac	
Rated impulse withstand voltage	Uimp 7.3kV	
Power frequency withstand voltage	3.8kV	
OUT1 and OUT 2 outputs		
Insulation type	Single between OUT1 and OUT 2 Double toward the remaining groups	
Rated insulation voltage	Ui 250VAC	
	Single	Double
Rated impulse withstand voltage	Uimp 4,8kV	Rated impulse withstand voltage
Power frequency withstand voltage	1,5kV	Power frequency withstand voltage
OUT 3 output		
Contact type	Ui 250Vac	
Rated current	Uimp 7.3kV	
Max rated voltage	3kV	
OUT4-5 and OUT 6-7 outputs		
Insulation type	Single between OUT4-5 and OUT 6-7 Double toward the remaining groups	
Rated insulation voltage	Ui 250Vac	
	Single	
Rated impulse withstand voltage	Uimp 4.8kV	Rated impulse withstand voltage

continues...

17. Technical characteristics

TECHNICAL CHARACTERISTICS		
Power frequency withstand voltage	1.5kV	Power frequency withstand voltage
Ambient operating conditions		
Operating temperature	-30÷70°C	
Storage temperature	-30÷80°C	
Relative humidity	<80% (IEC/EN 60068-2-78)	
Maximum pollution degree	2	
Overvoltage category	3	
Measurement category	III	
Climatic sequence	Z/ABDM (IEC/EN 60068-2-61)	
Shock resistance	15g (IEC/EN 60068-2-27)	
Vibration resistance	0.7g (IEC/EN 60068-2-6)	
Connections		
Terminal type	Plug-in / removable	
Cable cross section (min... max)	0.2-2.5 mm ² (24...12 AWG)	
Tightening torque	0.5 Nm	
Housing		
Version	Flush mount	
Material	Polycarbonate	
Degree of protection	IP40 on front IP20 terminals	
Weight	680g	
Certifications and compliance		
Certifications obtained	EAC	
Reference standards	IEC/EN 61010-1 IEC/EN 61000-6-2 IEC/EN 61000-6-3 IEC/EN 60947-6-1	

**Automatic transfer switch
4 226 81**

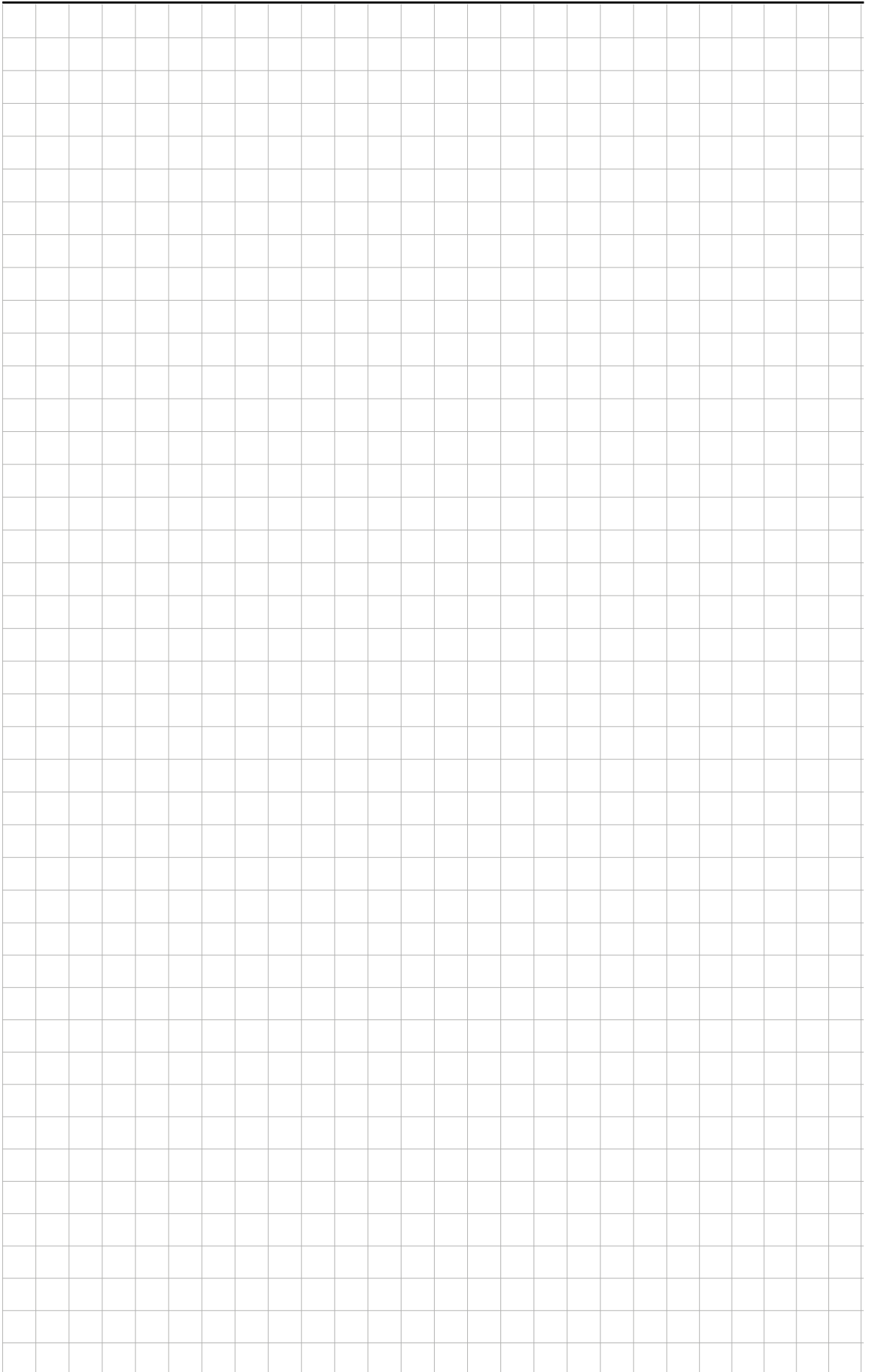

LEGRAND
Pro and Consumer Service
BP 30076 - 87002
LIMOGES CEDEX FRANCE
www.legrand.com

┌ Installer stamp ─┐

└ ─┘