



ZMTK 6.10 FL30.40 CU STTZN (460 147)

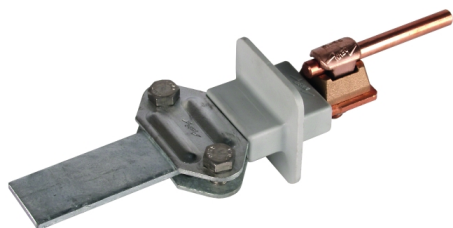
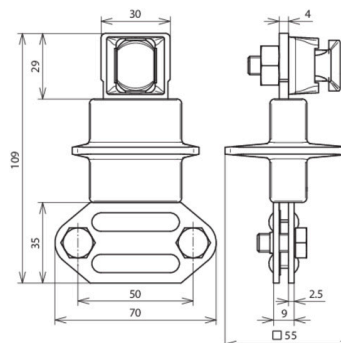

Figure without obligation



Arrangement:



Type	ZMTK 6.10 FL30.40 CU STTZN
Part No.	460 147
Material	Cu / St/tZn
Clamping range Rd / FI	6-10 / 30-40 mm
Screw	M8 x 16 mm
Material of screw	StSt
Shield	plastic grey
Lightning impulse current carrying capability (10/350 µs)	100 kA *)
Standard	EN 62561-1
Weight	340 g
Customs tariff number (Comb. Nomenclature EU)	85389099
GTIN	4013364025349
PU	1 pc(s)

*) For exact classification, see test certificate.

We reserve the right to introduce changes in performance, configuration and technology, dimensions, weights and materials in the course of technical progress. The figures are shown without obligation.