

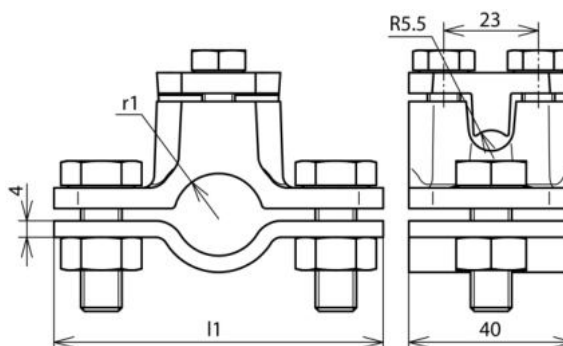

## ERS 34 AS4.10 TG STTZN (407 100)



Figure without obligation



Arrangement:

Type	ERS 34 AS4.10 TG STTZN
Part No.	407 100
Clamping range pipe Ø	34 mm
Material	MCl / St/tZn
Screw	⚙ M10 x 30 / M8 x 20 mm
Material of screw / nut	St/tZn
Dimensions (l1 x r1)	85 x 17.5 mm
Connection Rd Ø	4-10 mm
Conductor cross section	70 mm <sup>2</sup>
Lightning current carrying capability (10/350 µs)	<sup>*)</sup>
Standard	EN 62561-1
Weight	457 g
Customs tariff number (Comb. Nomenclature EU)	85389099
GTIN	4013364026124
PU	10 pc(s)

\*) For exact assignment, see test certificate.

We reserve the right to introduce changes in performance, configuration and technology, dimensions, weights and materials in the course of technical progress. The figures are shown without obligation.