

FK MV 8.10 KBF0.7 10 STTZN (365 220)

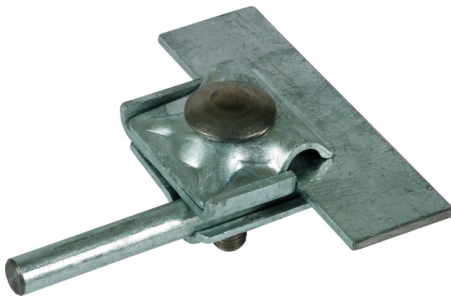
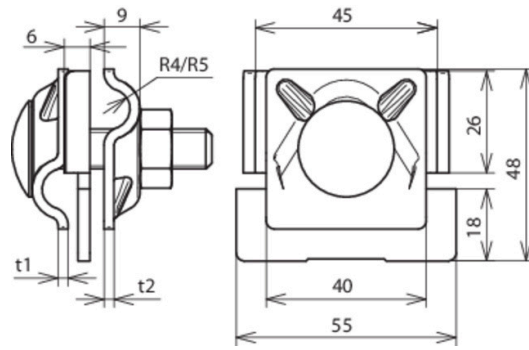

Figure without obligation



Arrangement:

Type	FK MV 8.10 KBF0.7 10 STTZN
Part No.	365 220 ✓
Clamping range of seam	0.7-10 mm
Material of clamp	St/tZn
Clamping range Rd	8-10 mm
Screw	⬆ M10 x 45 mm
Material of screw / nut	StSt
Material thickness	3 / 2.5 mm
Lightning current carrying capability (10/350 µs)	50 kA *)
Standard	EN 62561-1
Weight	171 g
Customs tariff number (Comb. Nomenclature EU)	85389099
GTIN	4013364096103
PU	50 pc(s)

*) For exact assignment see test certificate.

We reserve the right to introduce changes in performance, configuration and technology, dimensions, weights and materials in the course of technical progress. The figures are shown without obligation.