



FK DUL 8.10 KBF0.7 8 STTZN (365 010)

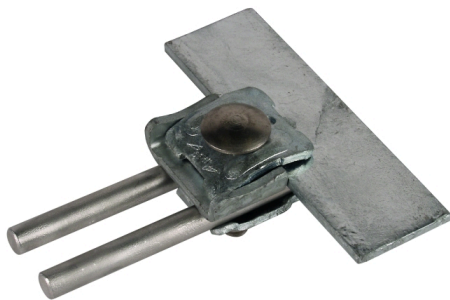
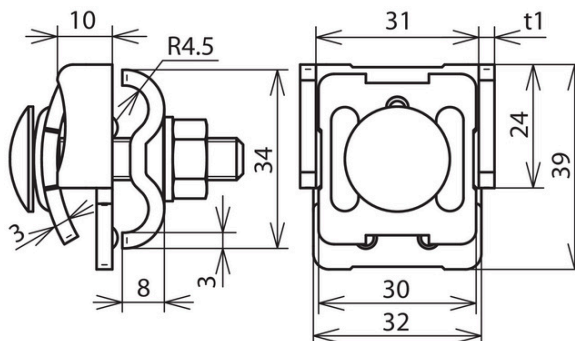

Figure without obligation



Arrangement:

Type	FK DUL 8.10 KBF0.7 8 STTZN
Part No.	365 010
Clamping range of seam	0.7-8 mm
Material of clamp	St/tZn
Material thickness (t1)	3 mm
Clamping range Rd	8-10 mm
Screw	⬆ M8 x 40 mm
Material of screw / nut	StSt
Lightning current carrying capability (10/350 µs)	50 kA ^{*)}
Standard	EN 62561-1
Weight	107 g
Customs tariff number (Comb. Nomenclature EU)	85389099
GTIN	4013364096318
PU	50 pc(s)

^{*)} For exact assignment see test certificate.

We reserve the right to introduce changes in performance, configuration and technology, dimensions, weights and materials in the course of technical progress. The figures are shown without obligation.