



KS 16 8.10 FL30 OV ZP STTZN (316 163)

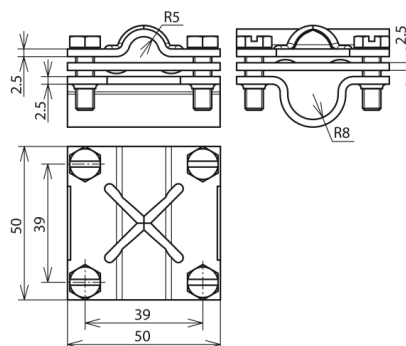
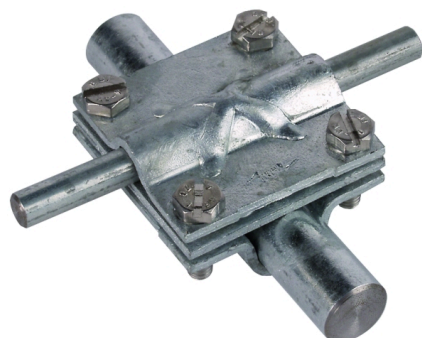

Figure without obligation

Arrangement:



Type	KS 16 8.10 FL30 OV ZP STTZN
Part No.	316 163
Material of clamp	SttZn
Clamping range Rd / Rd	16 / 8-10 mm
Clamping range Rd / FI	16 / 30 mm
Screw	M6 x 20 mm
Material of screw	StSt
Dimensions	50 x 50 x 2.5 mm
Intermediate plate	yes
Lightning current carrying capability (10/350 µs)	100 kA ^{*)}
Standard	EN 62561-1
Weight	191 g
Customs tariff number (Comb. Nomenclature EU)	85389099
GTIN	4013364024502
PU	1 pc(s)

^{*)} For exact assignment see test certificate.

We reserve the right to introduce changes in performance, configuration and technology, dimensions, weights and materials in the course of technical progress. The figures are shown without obligation.