

DLH DQ 6.10 H55 L410 WS STTZN (202 080)

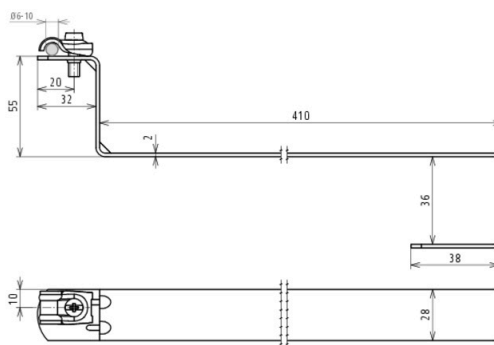

Figure without obligation



Type	DLH DQ 6.10 H55 L410 WS STTZN
Part No.	202 080
Material of roof conductor holder	St/tZn
Length of brace (l1)	410 mm
Material of conductor holder	St/tZn
Conductor support Rd	6-10 mm
Type of roofing	tiled roofs
Fixing possibility	for hooking at the roof battens
Type of conductor holder	DEHNquick
Conductor routing	fixed
Hole Ø	8.4 mm
Weight	250 g
Customs tariff number (Comb. Nomenclature EU)	85389099
GTIN	4013364020276
PU	50 pc(s)

We reserve the right to introduce changes in performance, configuration and technology, dimensions, weights and materials in the course of technical progress. The figures are shown without obligation.