

- For use in Ex zones 1 and 2 (gases, vapours, mists) as well as Ex zones 21 and 22 (dusts)
- Tested according to explosion group IIB
- Time-saving installation – no need to deactivate systems/areas for welding or drilling work



EX BRS 27 (540 821)

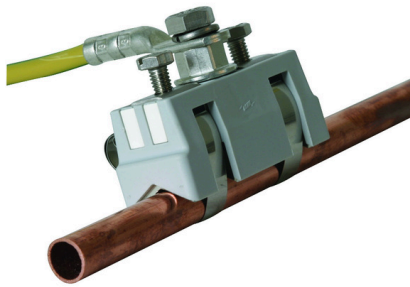
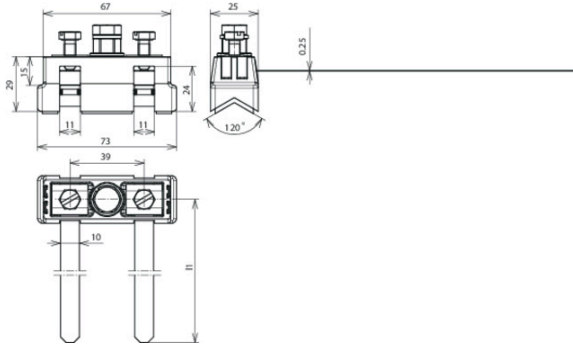

Figure without obligation



Arrangement:



Type	EX BRS 27
Part No.	540 821
Lightning impulse current (10/350 μ s) Cu \varnothing 6-12 mm (I_{imp})	10 kA
Lightning impulse current (10/350 μ s) Cu \varnothing 12-27 mm (3/4") (I_{imp})	20 kA
Lightning impulse current (10/350 μ s) Cu \varnothing 27 mm (3/4") (I_{imp})	25 kA
Lightning impulse current (10/350 μ s) St/tZn \varnothing 17-27 mm (3/4") (I_{imp})	25 kA
Lightning impulse current (10/350 μ s) StSt \varnothing 6-12 mm (I_{imp})	10 kA
Lightning impulse current (10/350 μ s) StSt \varnothing 12-27 mm (3/4") (I_{imp})	12 kA
Lightning impulse current (10/350 μ s) StSt \varnothing 27 mm (3/4") (I_{imp})	25 kA
Connection	M8
Clamping range pipe \varnothing	6-27 mm (3/4")
Material of clamp body	polyamide
Material of grip head / tensioning strap	StSt
Material of contact piece	brass/gal Sn
Dimensions of tensioning strap (l1 x w x d)	190 x 10 x 0.25 mm
Design	UV-stabilised
Standard	based on EN 62561-1
Weight	249 g
Customs tariff number (Comb. Nomenclature EU)	85389099
GTIN	4013364123724
PU	1 pc(s)

We reserve the right to introduce changes in performance, configuration and technology, dimensions, weights and materials in the course of technical progress. The figures are shown without obligation.

With regard to corrosion resistance, it must be checked whether the materials used for the Ex pipe clamps, Ex BRS ... (e.g. Cu/galSn, brass/galSn, StSt, polyamide) can be used in the existing ambient conditions.