

U21 New

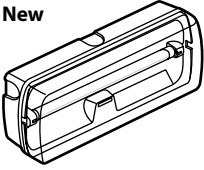

6 617 01/02/05/06/07/10/11/12 (NM)

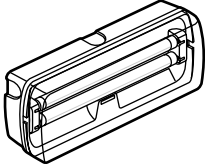

6 617 09/13 (C)

6 617 01	1h - NP (NM)	IP 42 - IK 04	70 lm	L 6 W 640 G5
6 617 02	1h - NP (NM)	IP 42 - IK 04	110 lm	L 6 W 840 G5
6 617 05	1h - NP (NM)	IP 42 - IK 04	160 lm	L 6 W 840 G5
6 617 06	1h - NP (NM)	IP 42 - IK 04	240 lm	L 6 W 840 G5
6 617 07	1h - NP (NM)	IP 42 - IK 04	300 lm	L 6 W 840 G5
6 617 09	1h - C	IP 42 - IK 04	160 lm	2 x L 6 W 840 G5
6 617 10	1h - NP (NM)	IP 42 - IK 04	50 lm	L 6 W 640 G5
6 617 11	3h - NP (NM)	IP 42 - IK 04	90 lm	L 6 W 840 G5
6 617 12	2h - NP (NM)	IP 42 - IK 04	160 lm	L 6 W 840 G5
6 617 13	2h - C	IP 42 - IK 04	110 lm	2 x L 6 W 840 G5

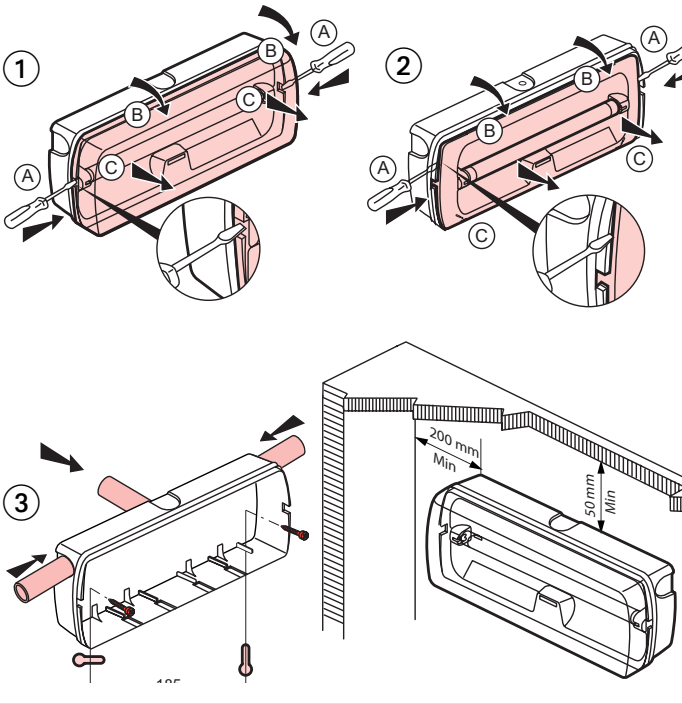

6 617 01/02/05/06/07/10/11/12 (NM)

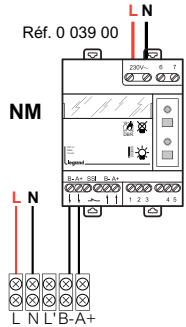

6 617 09/13 (C)

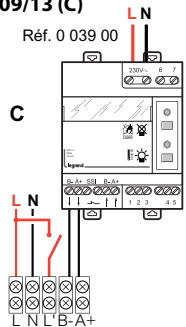

6 617 01/02/05/06/07/10/11/12 (NM)

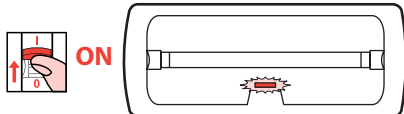

6 617 09/13 (C)

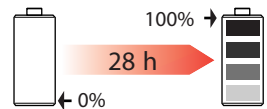
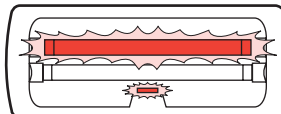

6 617 01/02/05/06/07/10/11/12 (NM)



OFF

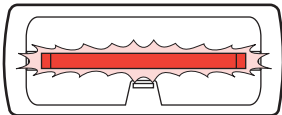

6 617 09/13 (C)



OFF

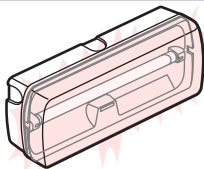
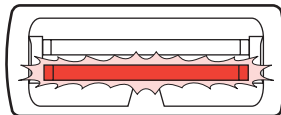

Lm = 100%

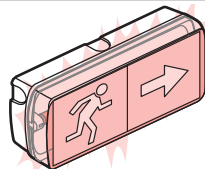

Lm = 50%

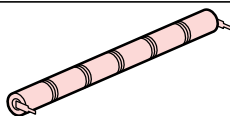

1h => 6 617 01/02/05/06/07/09/10

2h => 6 617 12/13

3h => 6 617 11



OFF

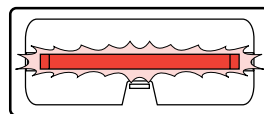
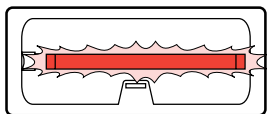

OK

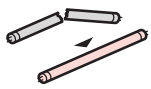
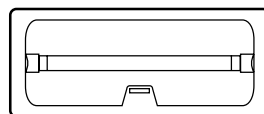

6 617 01/02/05/06/07/10/11/12 (NM)

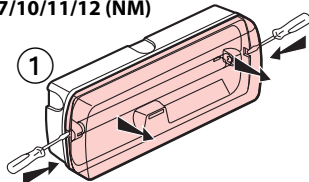

ON

2

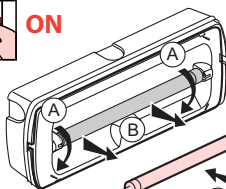

C



OFF

3

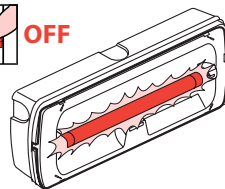

⚠ Consignes de sécurité

Ce produit doit être installé conformément aux règles d'installation et de préférence par un électricien qualifié. Une installation et une utilisation incorrectes peuvent entraîner des risques de choc électrique ou d'incendie. Avant d'effectuer l'installation, lire la notice, tenir compte du lieu de montage spécifique au produit.

Ne pas ouvrir, démonter, altérer ou modifier l'appareil sauf mention particulière indiquée dans la notice. Tous les produits Legrand doivent exclusivement être ouverts et réparés par du personnel formé et habilité par Legrand. Toute ouverture ou réparation non autorisée annule l'intégralité des responsabilités, droits à remplacement et garanties.

Utiliser exclusivement les accessoires de la marque Legrand.

FR LU BE CH

⚠ Sicherheitshinweise

Dieses Produkt darf nur durch eine Elektro-Fachkraft eingebaut werden. Bei falschem Einbau bzw. Umgang besteht das Risiko eines elektrischen Schlages oder Brandes.

Vor der Installation die Anleitung lesen, den produktspezifischen Montageort beachten. Das Gerät vorbehaltlich besonderer, in der Betriebsanleitung angegebener Hinweise nicht öffnen, zerlegen, beschädigen oder abändern. Alle Produkte von Legrand dürfen ausschließlich von durch Legrand geschultes und anerkanntes Personal geöffnet und repariert werden. Durch unbefugte Öffnung oder Reparatur erföschen alle Haftungs-, Ersatz- und Gewährleistungsansprüche.

Ausschließlich Zubehör der Marke Legrand benutzen.

DE

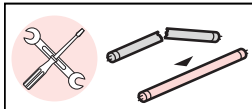

6617 09/13 (C)

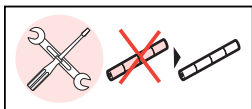
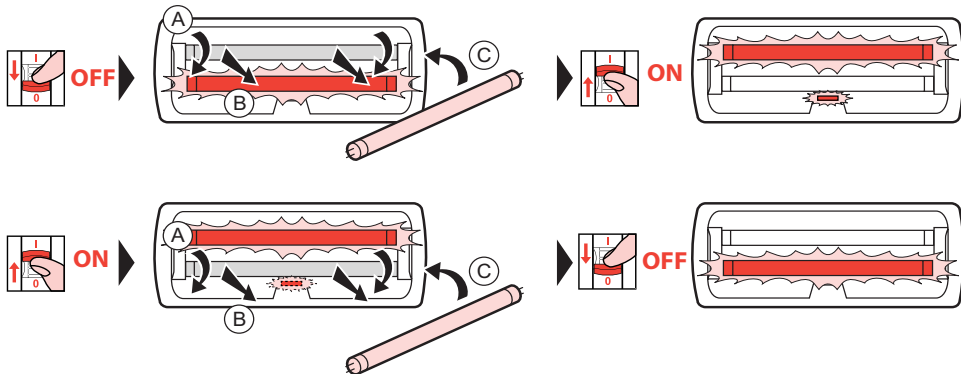

OFF

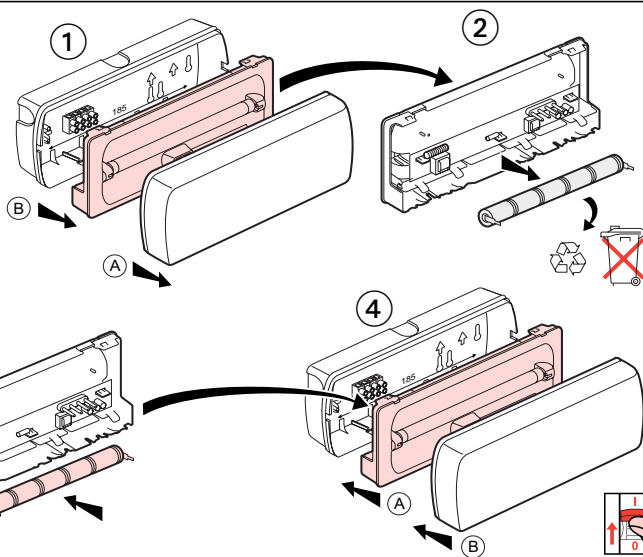

ON

Veiligheidsvoorschriften

Dit product moet in overeenstemming met de installatievoorschriften en bij voorkeur door een vakbekwame elektricien worden geïnstalleerd. Bij een onjuiste installatie en een onjuist gebruik bestaat het risico van elektrische schokken of brand.

Lees alvorens de installatie uit te voeren de handleiding door en houd rekening met de specifieke montageplaats van het product.

U mag het apparaat niet openen, demonteren of wijzigen, tenzij dat specifiek in de handleiding wordt vermeld. Alle Legrand-producten mogen uitsluitend worden geopend en gerepareerd door personeel dat door Legrand is opgeleid en bevoegd verklaard. In geval van ongeoorloofd openen of repareren wordt geen enkele aansprakelijkheid aanvaard, vervalt het recht op vervanging en zijn de garanties niet meer geldig.

Gebruik uitsluitend accessoires van het merk Legrand.

NL BE

Consignas de seguridad

Este producto debe instalarse conforme a las normas de instalación y preferiblemente por un electricista cualificado. Una instalación y una utilización incorrectas pueden entrañar riesgos de choque eléctrico o de incendio. Antes de efectuar la instalación, leer las instrucciones, tener en cuenta el lugar de montaje específico del producto.

No abrir, desmontar, alterar o modificar el aparato salvo que esto se indique específicamente en las instrucciones. Todos los productos Legrand deben ser abiertos y reparados exclusivamente por personal formado y habilitado por Legrand. Cualquier apertura o reparación no autorizada anula la totalidad de las responsabilidades, derechos a sustitución y garantías.

Utilizar exclusivamente los accesorios de la marca Legrand.

ES

Safety instructions

This product should be installed in line with installation rules, preferably by a qualified electrician. Incorrect installation and use can lead to risk of electric shock or fire. Before carrying out the installation, read the instructions and take account of the product's specific mounting location.

Do not open up, dismantle, alter or modify the device except where specifically required to do so by the instructions. All Legrand products must be opened and repaired exclusively by personnel trained and approved by Legrand. Any unauthorised opening or repair completely cancels all liabilities and the rights to replacement and guarantees.

Use only Legrand brand accessories.

GB IE

Instruções de segurança

Este produto deve ser instalado de acordo com as regras de instalação e de preferência por um electricista qualificado. A instalação e o uso incorrectos podem provocar riscos de choque eléctrico ou de incêndio.

Antes de efectuar a instalação, ler as instruções e ter em conta a localização adequada para a montagem do produto. Não abrir, desmontar, alterar ou modificar o aparelho salvo especificação em contrário nas instruções do produto. Todos os produtos Legrand só devem ser abertos e reparados exclusivamente por pessoal formado e autorizado pela Legrand. Qualquer abertura ou reparação não autorizada cancela todas as responsabilidades, direitos de substituição e garantias. Utilizar exclusivamente os acessórios da marca Legrand.

PT

0 039 00/01

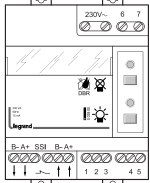

- Luminarias de emergencia en estado de reposo durante periodos de no funcionamiento del edificio
- Rest mode of the emergency lighting luminaires out of building's opening periods
- Rusttoestand van de veiligheidsverlichting buiten de operationele periode van het gebouw

- Mise à l'état de repos des luminaires d'éclairage de secours en dehors des périodes d'exploitation du bâtiment
- Ruhezustand der Einzelbatterieleuchten ausserhalb der Nutzungszeiten des Gebäudes
- Modo estado de reposo dos blocos de iluminação de emergência, quando o edifício não está no período de atividade

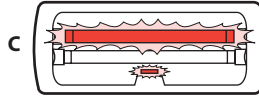
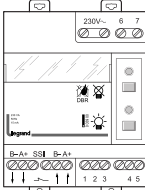

NM (NP)

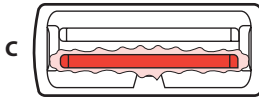
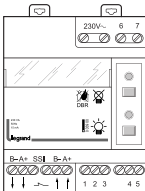
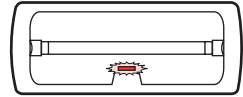

NM (NP)

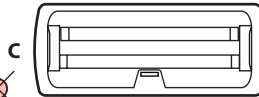
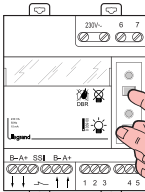
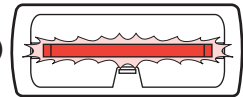

NM (NP)

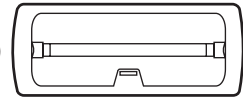

- Apagado general de luminarias de emergencia
- Complete switching off the emergency lighting

- Volledige uitschakeling van de veiligheidsverlichting
- Extinction complète des luminaires d'éclairage de secours

- Komplettes Erlöschen der Einzelbatterieleuchten
- Extinção completa da iluminação de emergência

3

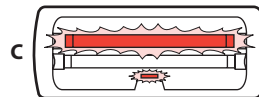
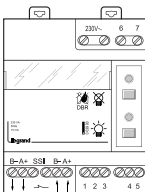
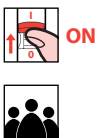

NM (NP)

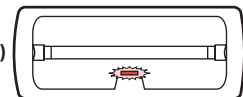

TEST

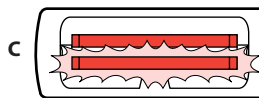
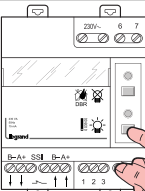

NM (NP)

