

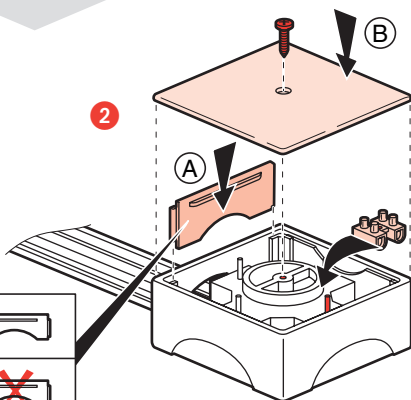

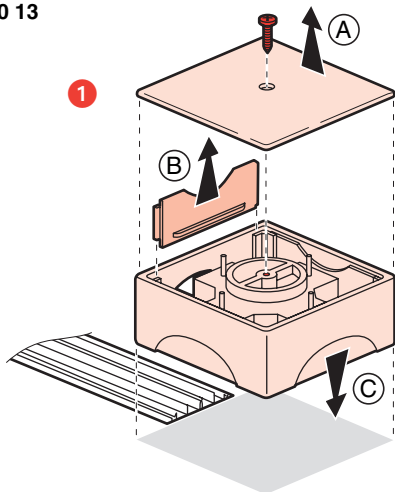



300 13

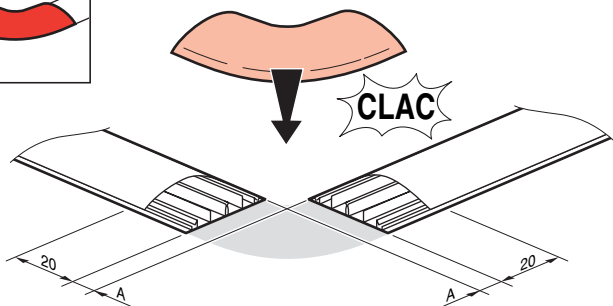
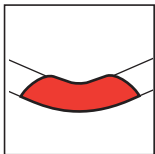

|  |            |   |
|--|------------|---|
|  | 50 x 12 mm |  |
|  | 75 x 18 mm |  |

300 11/18



|  | A  |
|--|----|
|  50 x 12 mm | 10 |
|  75 x 18 mm | 20 |

300 12/19

