



• Caractéristiques techniques		• Technical specifications		• Características técnicas									
• Technische gegevens		• Technische Daten		• Caratteristiche tecniche									
• Catégorie d'emploi	• Anwendungsklasse												
• Toepassingscategorie	• Categoría de utilización												
• Utilization category	• categoria di impiego												
Ui = 690V~ -20 à +70°C		PR12		PR17		PR21		PR26		PR40		PR63	
		le (A)	P (KW)	le (A)	P (KW)	le (A)	P (KW)	le (A)	P (KW)	le (A)	P (KW)	le (A)	P (KW)
AC 21		16		20		25		32		50		63	
AC 23 3 X 230V			4		5,5		7,5		11		15		18,5
AC 23 3 X 400V			7,5		11		11		11		22		25
AC 3 3 X 400V			4		7,5		7,5		11		18,5		22
		4mm ²		6mm ²		6mm ²		6mm ²		16mm ²		16mm ²	
		4mm ²		4mm ²		4mm ²		6mm ²		16mm ²		16mm ²	

<ul style="list-style-type: none"> • Montage encastré • Inbouw montage • Flush mounting 	<ul style="list-style-type: none"> • Einbau • Montaje empotrado • montaggio ad incastro 	<ul style="list-style-type: none"> • Fixation • Bevestiging • Fixing 	<ul style="list-style-type: none"> • Befestigung • Fijación • Fissaggio 	<ul style="list-style-type: none"> • Montage encastré Ø 22 • Inbouw montage Ø 22 • Flush mounting Ø 22 	<ul style="list-style-type: none"> • Einbau Ø 22 • Montaje empotrado Ø 22 • montaggio ad incastro Ø 22
--	--	---	--	---	---

IP 40

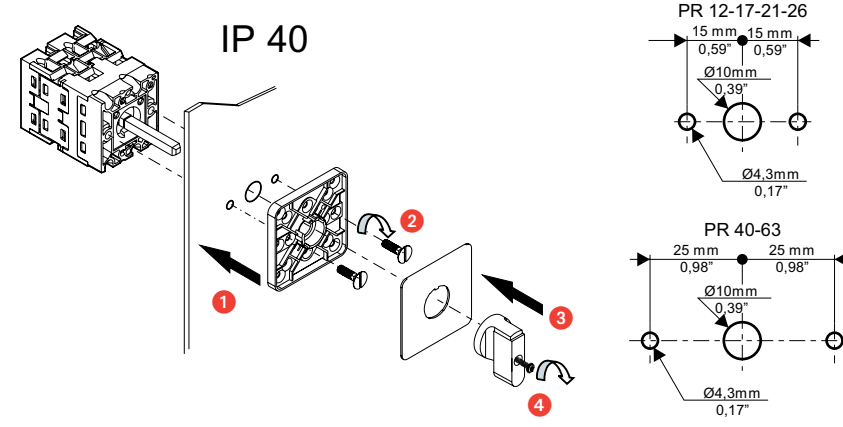

PR 12-17-21-26
15 mm 15 mm
0,59" 0,59"
Ø10mm 0,39"
Ø4,3mm 0,17"

PR 40-63
25 mm 25 mm
0,98" 0,98"
Ø10mm 0,39"
Ø4,3mm 0,17"

IP 40

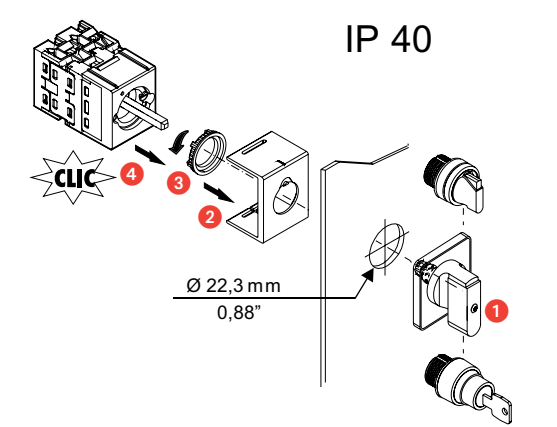

Ø 22,3 mm
0,88"

<ul style="list-style-type: none"> • Démontage Boîtiers • Demontage behuizingen • Disassembly of casing 	<ul style="list-style-type: none"> • Ausbau des Gehäuses • Desmontaje de la carcasa • smontaggio scatola 	<ul style="list-style-type: none"> • Fixation • Bevestiging • Fixing 	<ul style="list-style-type: none"> • Befestigung • Fijación • Fissaggio
--	---	---	--

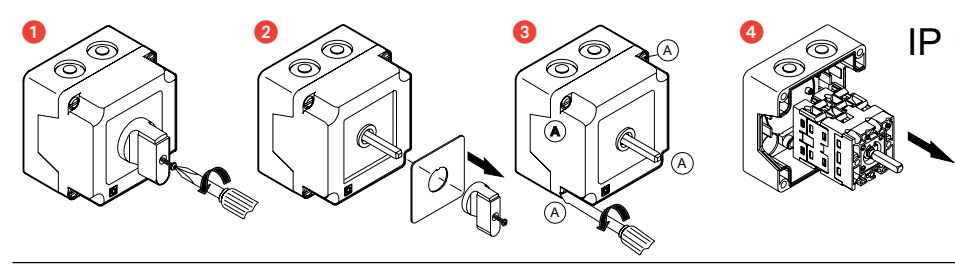

IP 65

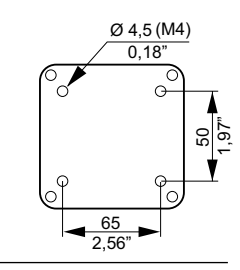

Ø 4,5 (M4)
0,18"

65 2,56"

50 1,97"

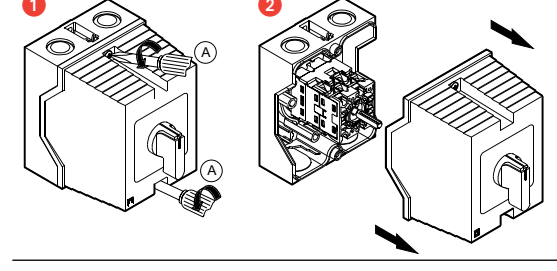

IP 65

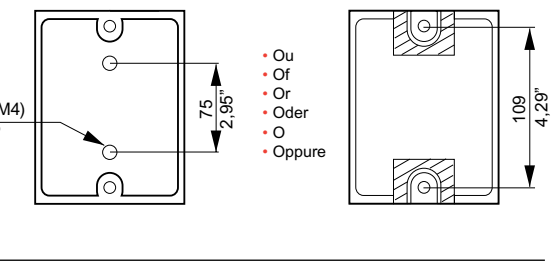

Ø 4,5 (M4)
0,18"

75 2,95"

109 4,29"

- Ou
- Of
- Or
- Oder
- O
- Oppure

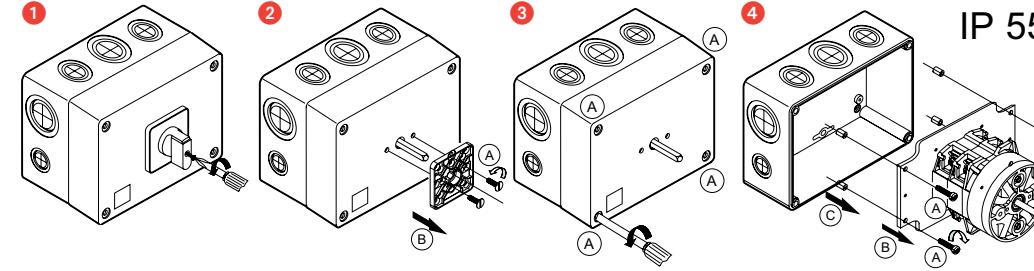

IP 55

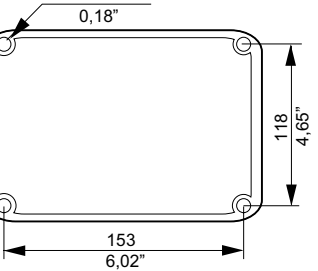

Ø 4,5 (M4)
0,18"

153 6,02"

118 4,65"

• Raccordement
• Aansluiting

- Interrupteur
- Schakelaar
- Switch
- Schalter

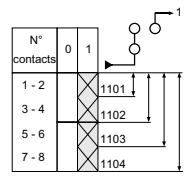

• Connection
• Anschluss

- Inverseur
- Kruisschakelaar

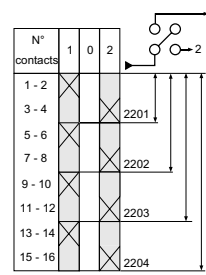

• Conexión
• Collegamento

- Changeover switch
- Wechsler
- Inversor
- Invertitore

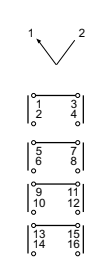
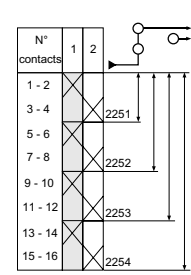
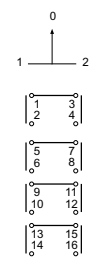
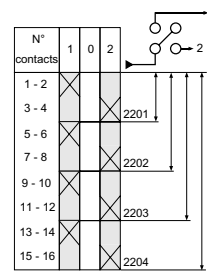

• Commutateur de direction
• Richting omschakeleer

• Direction selector switch
• Richtungsumschalter

• Conmutador de dirección
• Commutatore di direzione

- N° de schéma
- Schema N°
- Diagram No.
- Zeichnungs-Nr.
- N° de esquema
- N° di schema

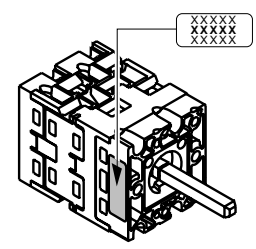
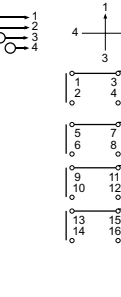
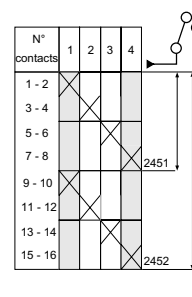
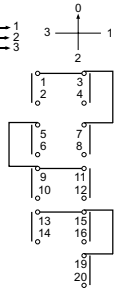
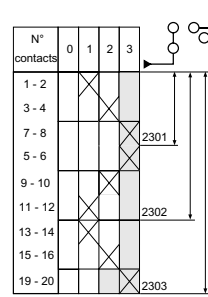
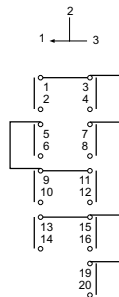
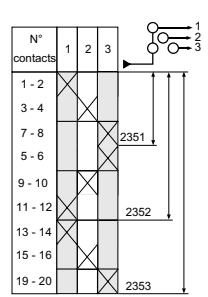

• Commutateur de mesure / Ampèremètre
• Omschakelaar voor Amperemeter

• Metering selector switch / Ammeter
• Messumschalter / Amperemeter

• Conmutador de medida / Amperímetro
• Commutatore di misura/Amperometro

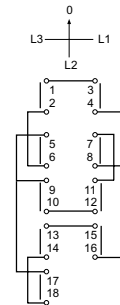
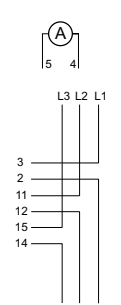
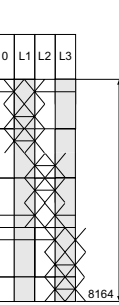
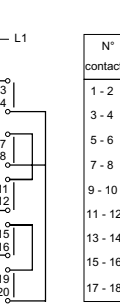
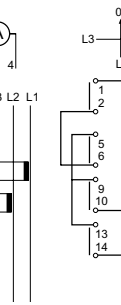
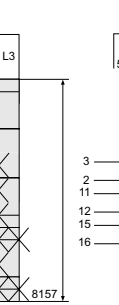
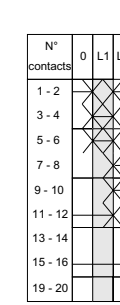
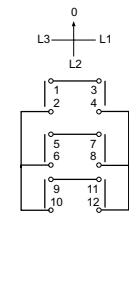
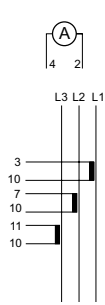
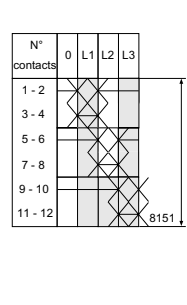

• Commutateur de mesure / Voltmètre
• Omschakelaar voor Voltmeter

• Metering selector switch / Voltmeter
• Messumschalter / Voltmeter

• Conmutador de medida / Voltímetro
• Commutatore di misura/Voltmetro

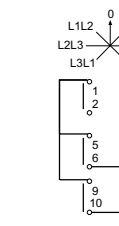
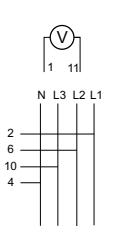
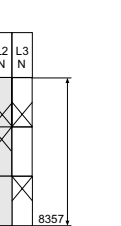
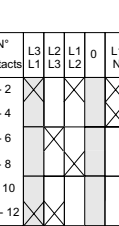
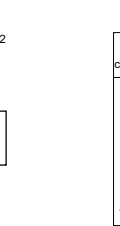
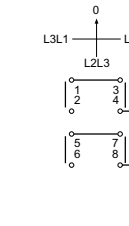
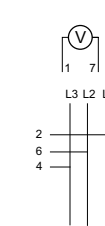
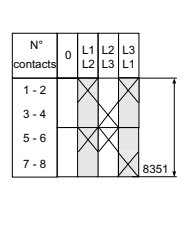

• Commutateur de moteur triphasé
• Omschakelaar 3 fazige motor

• Three-phase motor switch
• Dreiphasenmotorschalter

• Conmutador de motor trifásico
• Commutatore di motore trifase

