

| CONTENT | PAGE |
|--|-------------|
| ■ 1. Use | 2 |
| ■ 2. Technical features | 2 |
| 2.1 Electrical features | 2 |
| 2.2 Climatic features | 2 |
| 2.3 Mechanical features | 2 |
| ■ 3. Dimensions | 2 |
| ■ 4. Connection | 2 |
| ■ 5. Removal | 2 |
| ■ 6. Installation | 3 |
| 6.1 Sensor positioning | 3 |
| 6.2 Recommended light exposure | 3 |
| 6.3 Fitting | 3 |
| ■ 7. Operation | 4 |
| ■ 8. Settings | 4 |
| 8.1 Detection parameters | 4 |
| 8.2 Lighting parameters | 4 |
| 8.3 Other parameters | 4 |
| 8.4 Modifying the parameters using the configuration tools | 5 |
| ■ 9. Performance | 5 |
| 9.1 PIR Performance - Motion detection | 5 |
| 9.2 PIR Performance - Presence detection | 5 |
| ■ 10. Standards and approvals | 5 |
| ■ 11. Maintenance | 5 |
| ■ 12. Communication objects | 6 |
| 12.1 List of objects | 6 |
| 12.2 General parameters | 7 |
| 12.2.1 Main function - Master: Light level only | 7 |
| 12.2.2 Main function - Master: Detection only | 11 |
| 12.2.3 Main function - Master: Light level & Detection | 13 |
| 12.2.4 Slave: Detection only | 21 |
| 12.3 Load | 22 |
| 12.3.1 Use dimming load | 22 |
| 12.3.2 Use expert parameters | 23 |
| 12.3.3 Standby time base (function only available in Master mode: detection and Master: Light level & Detection) | 24 |
| 12.3.4 Use second load | 26 |
| 12.4 Light level config | 27 |
| 12.4.1 Use external daylight cell | 27 |
| 12.5 Detection config | 29 |
| 12.6 Auxiliary output | 31 |
| 12.6.1 None | 31 |
| 12.6.2 Switching | 31 |
| 12.6.3 Scaled values | 32 |
| 12.6.4 HVAC Mode | 33 |
| 12.6.5 Scene | 34 |
| 12.6.6 2 bytes value | 35 |
| 12.7 Advanced | 36 |
| 12.7.1 Sensitivity (only available for Master: Detection Only, Master: Light level & Detection and Slave: Detection Only modes) | 36 |
| 12.7.2 System detection (only available for Master: Detection Only, Master: Light level & Detection and Slave: Detection Only modes) | 36 |
| 12.7.3 Additional object for expert mode | 37 |
| 12.8 Virtual Keycard | 38 |
| 12.8.1 Use Virtual Keycard | 38 |
| 12.8.2 Virtual keycard function operating diagram | 42 |
| 12.9 Commissioning Tool | 43 |
| ■ 13. Application's examples | 44 |
| 13.1 Mode Auto ON/OFF – Load ON/OFF | 44 |
| 13.2 Mode Auto ON/OFF – Dimming load | 44 |
| 13.3 Mode Manual ON/Auto OFF – Load ON/OFF | 44 |
| 13.4 Mode Manual ON/AutoOFF – Dimming load | 45 |
| 13.5 Master/Slave detection | 45 |

1. USE

The KNX sensor ref. 0 489 22 is a passive infrared device (PIR) suitable to detect presence and measure the daylight level.

It can be installed recessed on false ceilings through springs, recessed on concrete ceilings using the installation box ref. 0 800 31 or it can be also installed on the ceiling surface using the surface installation box ref. 0 488 75.

It is suitable for indoor working areas like offices, conference rooms, meeting rooms...

Through its application program it is possible to configure all the working parameters such as daylight threshold, time delay, operating modes, technology sensibility... and it is possible to configure the following functions:

- Switching/dimming: automatically or manually if associated with a control device
- Define a minimum/maximum dimming level
- Customize the dimming pace
- Trigger scenarios based on: presence/absence
- Work in master/slave configuration
- Define a daylight level to be maintained until presence is detected
- Manage more than one output with the same commands

All the working parameters are configurable via ETS but is also possible to modify the main operating parameters (daylight threshold, time delay, technology sensibility...) via commissioning tool ref. 088230/ BMSO4001.

2. TECHNICAL FEATURES

2.1 Electrical features

- KNX BUS power supply: 29 V=
- KNX BUS absorption: 16 mA (PIR)
- KNX connector (red/black): terminal capacity 4x (Ø 0,6 à 0,8 mm)

2.2 Climatic features

- Environmental operating temperature: -5°C to +45°C
- Storage temperature: -25°C to +70°C

2.3 Mechanical features

- Impact resistance: IK04
- Penetration by solid and liquid matter: IP20

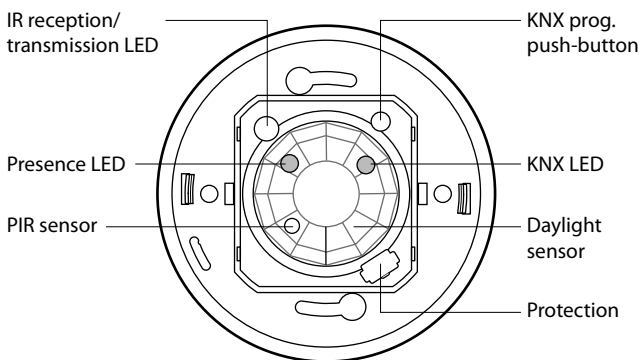

3. DIMENSIONS

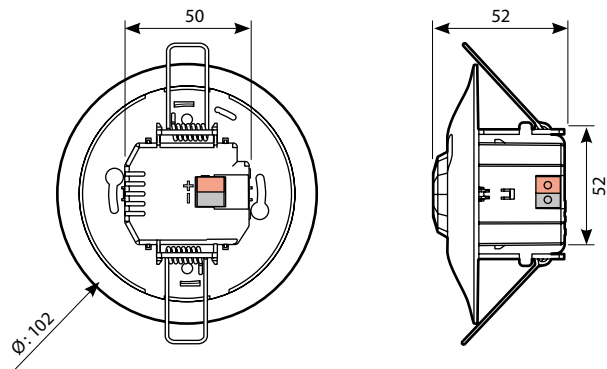

4. CONNECTION

KNX red/black connector

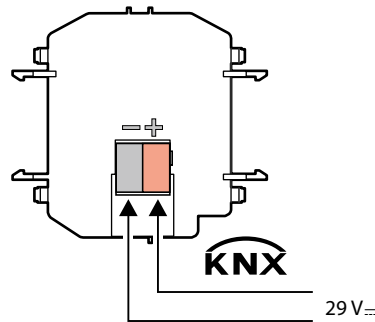
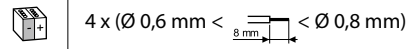

5. REMOVAL

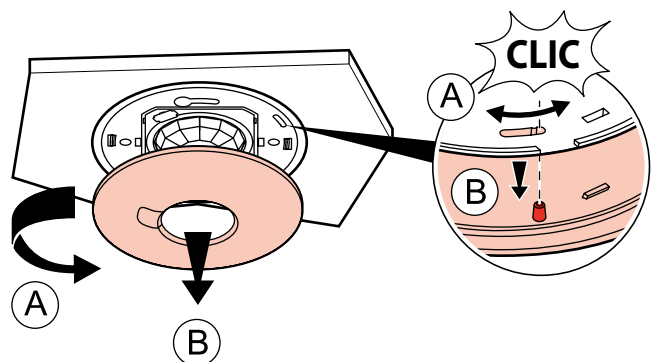

6. INSTALLATION

■ **6.1 Sensor positioning**

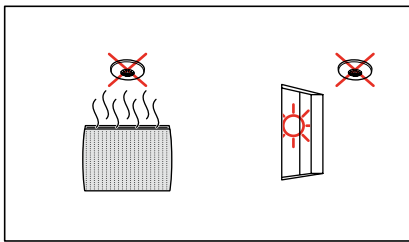
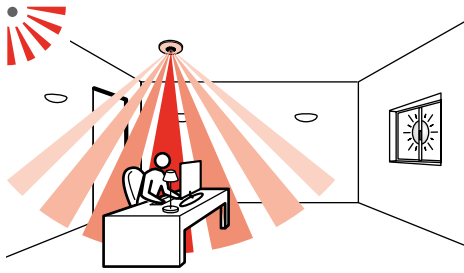

■ **6.2 Recommended light exposure**

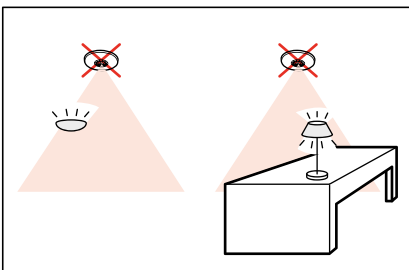
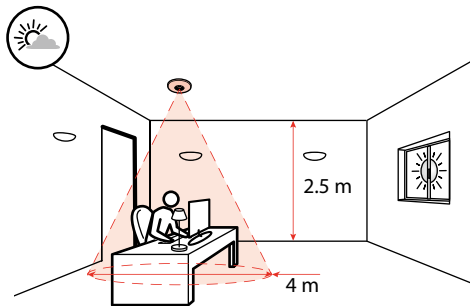

6. INSTALLATION (continued)

■ **6.3 Fitting**

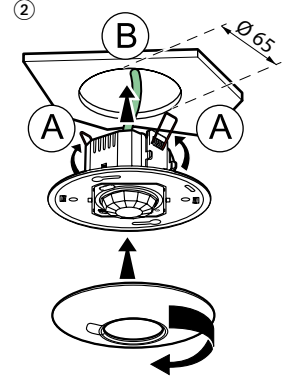
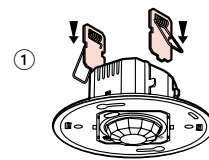
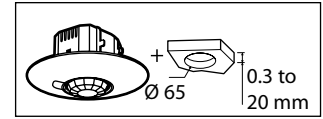
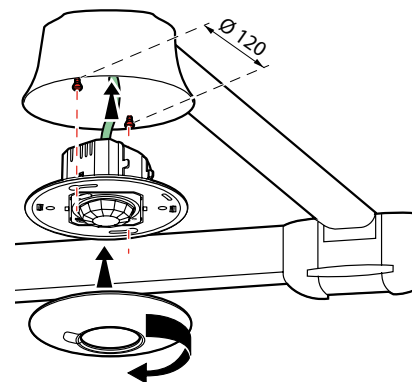
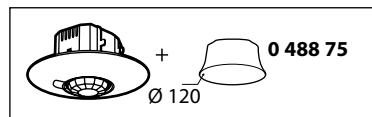
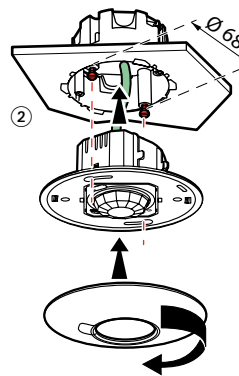
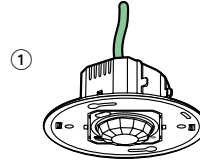
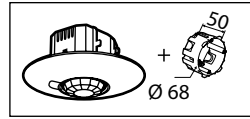

7. OPERATION

The KNX sensors offer many functions, on follows a summary of them (see section "Communication objects" for details):

Functions:

Automatic or manual switching/dimming with constant daylight regulation

Possibility to control a second lighting level as a % of the main one maintaining a positive or negative offset.

Coupling several detectors: It is possible to set the sensors in Master or slave configuration in order to cover a larger area with a synchronized presence detection.

Sending message on presence / absence: Upon presence/absence can be sent an additional command: switching command, values, scene...

Warning of end detection: After the time delay, the light can be configured to assume a standby level (for a standby time interval) as to warn of the imminent extinction.

Presence and brightness level information is available on the bus: Values available for a supervision system.

Daylight setpoint and time delay modifiable by bus: Values which can be modified by a supervision system.

Partial on/Group off Mode:

It is possible to turn ON just a subset of lights but at the end of time delay turn OFF all the lights. Classroom example: Room Lighting: automatic switch ON; Board Lighting: manual control. On end detection, total extinction, room and board.

Virtual Keycard: Especially thought for hotels, the combination of presence sensors, door contacts and other informations (e.g. other detectors, push buttons...) allow determining the presence in the room and empower some circuits in the room, launch scenarios or any other kind of logics.

The functions is triggered by the "door contact" event which launch the so called "Virtual keycard time delay", a time offset in which the sensor tries to understand if the room is occupied or not on the basis of some informations: sensor detection, window contact events, push buttons event. Once the result of the function is "occupied" it remains until there is another "Door contact event" which trigger another "Virtual keycard time delay" to understand the room status and eventually turn OFF the lights, launch an absence scenario or launch any other logic related to vacancy event.

The product global configuration is made via ETS (version 3 or upper) and it is also possible to modify the main operating parameters via commissioning tool 088230/BMSO4001 (see following section for futher details)

8. SETTINGS

Following the main operating parameters modifiable via commissioning tool 088230/BMSO4001.

■ 8.1 Detection parameters

| Sensor parameter | Default value | Possible values | Configuration tools 088230/BMSO4001 |
|------------------|-----------------|------------------------------|-------------------------------------|
| Time delay | 15 min | 5 s - 17 H 59 min 59 s | ✓ |
| Sensitivity | PIR (Very high) | Low, Medium, High, Very high | ✓ |
| Detection system | Initial | PIR | No modifiable |
| | Maintain | PIR | No modifiable |

 **Time delay:** It is the time interval between the moment in which a sensor does not detect motion/presence and the deactivation of the load. The time period re-starts whenever the sensor detects motion/presence

 **Sensitivity:** It is the detection technology sensitivity.

Detection system:

It is the set of technologies used for detection

Initial detection: it is the set of technologies used for the first detection

Maintain: it is the set of technologies used after the first detection

■ 8.2 Lighting parameters

| Sensor parameter | Default value | Possible values | Configuration tools 088230/BMSO4001 |
|-------------------|---------------|-----------------|-------------------------------------|
| Daylight setpoint | 500 lux | 5 - 1275 lux | ✓ |

 **Daylight setpoint:** it is the lighting level under which the sensor enables the load and over which the sensor disables the load.

 **Eye function:** Value 0 (eye on configuration tool 088230/BMSO4001) this function allows to record in the sensor the actual general lighting level and use it as daylight setpoint.

■ 8.3 Other parameters

| Sensor parameter | Default value | Possible values | Configuration tools 088230/BMSO4001 |
|------------------|---------------------------|-----------------|-------------------------------------|
| Output | Standby delay (main load) | Disabled | Disabled/infinite/1 s - 1 h |
| | Standby level (main load) | 10 % | 1 - 100 % |

Standby level: it is the level, expressed in % of the daylight setpoint, at which the load is keep turned ON during the standby delay.

Standby delay: it is the time interval in which the load is kept turned ON at the standby level. It begins as soon as the sensor does not detect motion/presence

8. SETTINGS (continued)

8.4 Modifying the parameters using the configuration tools

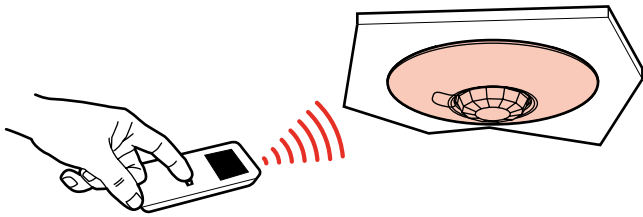

• 088230/BMSO4001: Advanced configuration tool
 When the sensor receives an IR command via a configuration tool, the LED blinks.

- Restore to factory settings:

- 1st press: Short press on PROG, the LED flashes slowly.
- 2nd press: Hold down PROG for 10 seconds until the LED flashes quickly.

9. PERFORMANCE

9.1 PIR Performance - Motion detection

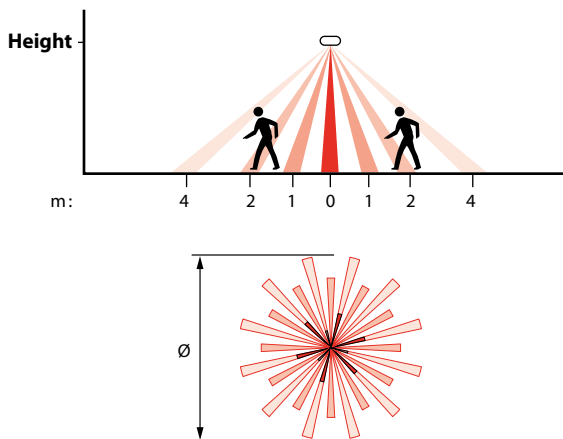

| Height (m) | Sensitivity Low (25%) | | Sensitivity Medium (50%) | |
|------------|-----------------------|---------------------------|--------------------------|---------------------------|
| | Ø (m) | surface (m ²) | Ø (m) | surface (m ²) |
| 2,5 | 4 | 15 | 6 | 25 |
| 3 | 5,5 | 25 | 6,5 | 35 |
| 4 | 6,5 | 35 | 7,5 | 45 |
| 5 | 6 | 30 | 10,5 | 90 |
| 6 | 4 | 15 | 5,5 | 25 |

| Height (m) | Sensitivity High (75%) | | Sensitivity Very high (100%) | |
|------------|------------------------|---------------------------|------------------------------|---------------------------|
| | Ø (m) | surface (m ²) | Ø (m) | surface (m ²) |
| 2,5 | 6,5 | 30 | 8 | 50 |
| 3 | 8,5 | 60 | 11,5 | 100 |
| 4 | 12,5 | 125 | 14 | 155 |
| 5 | 12 | 115 | 16,5 | 215 |
| 6 | 8,5 | 60 | 12,5 | 125 |

9. PERFORMANCE (continued)

9.2 PIR Performance - Presence detection

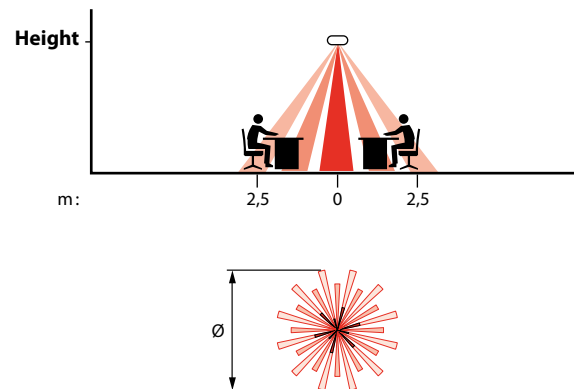

| Height (m) | Sensitivity Low (25%) | | Sensitivity Medium (50%) | |
|------------|-----------------------|---------------------------|--------------------------|---------------------------|
| | Ø (m) | surface (m ²) | Ø (m) | surface (m ²) |
| 2,5 | 4 | 15 | 6 | 25 |
| 3 | 5,5 | 25 | 6,5 | 35 |
| 4 | 6,5 | 35 | 7,5 | 45 |
| 5 | 6 | 30 | 10,5 | 90 |
| 6 | 4 | 15 | 5,5 | 25 |

| Height (m) | Sensitivity High (75%) | | Sensitivity Very high (100%) | |
|------------|------------------------|---------------------------|------------------------------|---------------------------|
| | Ø (m) | surface (m ²) | Ø (m) | surface (m ²) |
| 2,5 | 6,5 | 30 | 8 | 50 |
| 3 | 8,5 | 60 | 11,5 | 100 |
| 4 | 12,5 | 125 | 14 | 155 |
| 5 | 12 | 115 | 16,5 | 215 |
| 6 | 8,5 | 60 | 12,5 | 125 |

10. STANDARDS AND APPROVALS

- Complies with standard IEC 60 669.2.1
- Marking: KNX, CE

Note:

All technical information is available at



11. MAINTENANCE

Clean the surface with a cloth.
 Do not use acetone, tar-removing cleaning agents or trichloroethylene.

Caution:

Always test before using other special cleaning products.

12. COMMUNICATION OBJECTS

■ 12.1 List of objects

Here are listed the communication objects active by default settings.

| No. | Object name | Function | Size | Flags |
|-----|-------------|-----------|-----------------|-------|
| 1 | Switching | Switching | 1.001 DP_On/Off | CT |

Switching telegrams are sent via the group address linked to this object

| | | | | |
|---|------------------|------------------|-----------------|------|
| 2 | Switching Status | Switching Status | 1.001 DP_On/Off | CWTU |
|---|------------------|------------------|-----------------|------|

Switching statuses are received via the group address linked to this object.

*If switching statuses are received but the Switching object has not been sent by the sensor, the regulation is stopped.

| | | | | |
|---|--------------|--------------|---------------|----|
| 5 | In Occupancy | In Occupancy | 1.002 DP_Bool | CW |
|---|--------------|--------------|---------------|----|

In Occupancy statuses are received via the group address linked to this object.

It will be used especially for connecting slave sensor and increase a detection zone (13.5 Master/slave detection).

True: The sensor reacts as if there is an internal detection

False: No reaction

| | | | | |
|---|------------------|------------------|---------------|-----|
| 6 | Occupancy status | Occupancy status | 1.002 DP_Bool | CRT |
|---|------------------|------------------|---------------|-----|

Out Occupancy statuses are sent via the group address linked to this object

True: When motion is detected

False: After vacancy time delay, or occupancy if vacancy is not used

| | | | | |
|---|---------|---------|--------------|-----|
| 8 | Out Lux | Out Lux | 9.004 DP_Lux | CRT |
|---|---------|---------|--------------|-----|

Out Lux values are sent via the group address linked to this object.

Send operations can be set in ETS (Cyclical, on change, on request).

| | | | | |
|----|---------------------|---------------------|-----------------|-----|
| 16 | Switching group off | Switching group off | 1.001 DP_On/Off | CRT |
|----|---------------------|---------------------|-----------------|-----|

Switching group off statuses are sent via the group address linked to this object.

On vacancy is sent an OFF via the group address linked to this object.

| | | | | |
|----|---------------|---------------|---------------|----|
| 20 | Out occupancy | Out occupancy | 1.002 DP_Bool | CT |
|----|---------------|---------------|---------------|----|

Out synchro Master-> Slave statuses are sent via the group address linked to this object

True: The maintain status is sent to the slave

False: The initial status is sent to the slave

| | | | | |
|----|--------|--------|-----------------|-----|
| 21 | Enable | Enable | 1.003 DP_Enable | CRW |
|----|--------|--------|-----------------|-----|

Enable telegrams are received via the group address linked to this object.

They are used to lock (disable) or unlock (enable) the corresponding input.

12. COMMUNICATION OBJECTS (continued)

■ **12.2 General parameters**

12.2.1 Main function - Master: Light level only

| Parameters | Settings |
|---------------|---|
| Main function | Master: Light level only Master: Detection only Master: Light level & detection Slave: Detection only |

Only load and light level can be configured in the associated page, and regulation is active

12.2.1.1 Mode

• **Auto on/Auto off mode**

Comes on automatically: - At the detection of a presence if there is an insufficient natural level of light. Turns off automatically: - If no presence is detected and at the end of the time delay set. - Or if there is a sufficient natural level of light (activated setting).

Any new detection causes an automatic switch on if there is insufficient light.

• **Walkthrough**

- If there is no presence detected in the 3 minutes following an initial detection, the product will cut off after 3 minutes.

- If a new presence is detected in the 3 minutes following the initial detection, the device will cut off at the end of the time delay set.

Manual on/Auto off mode: Comes on via a manual switch, automatic switch off: - Where no presence is detected and at the end of the time delay set.

Following switch-off any new detection within a 30 second period will cause the device to be switched on automatically.

After 30 seconds the device is switched on via a manual switch.

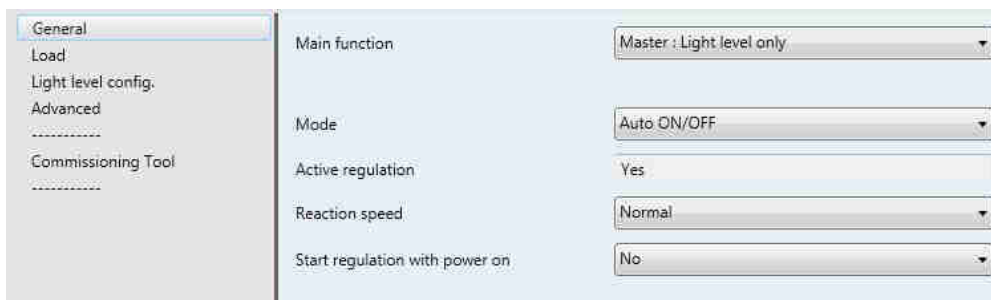

| Parameters | Settings |
|----------------|---|
| Reaction speed | Very Low Low Normal Fast Very Fast |

This parameter determines the speed reaction of the régulation in dimming or switching

| Parameters | Settings |
|--------------------------------|------------------|
| Start regulation with power on | Yes No |

This parameter determines if regulation is started with power on

System behaviour:

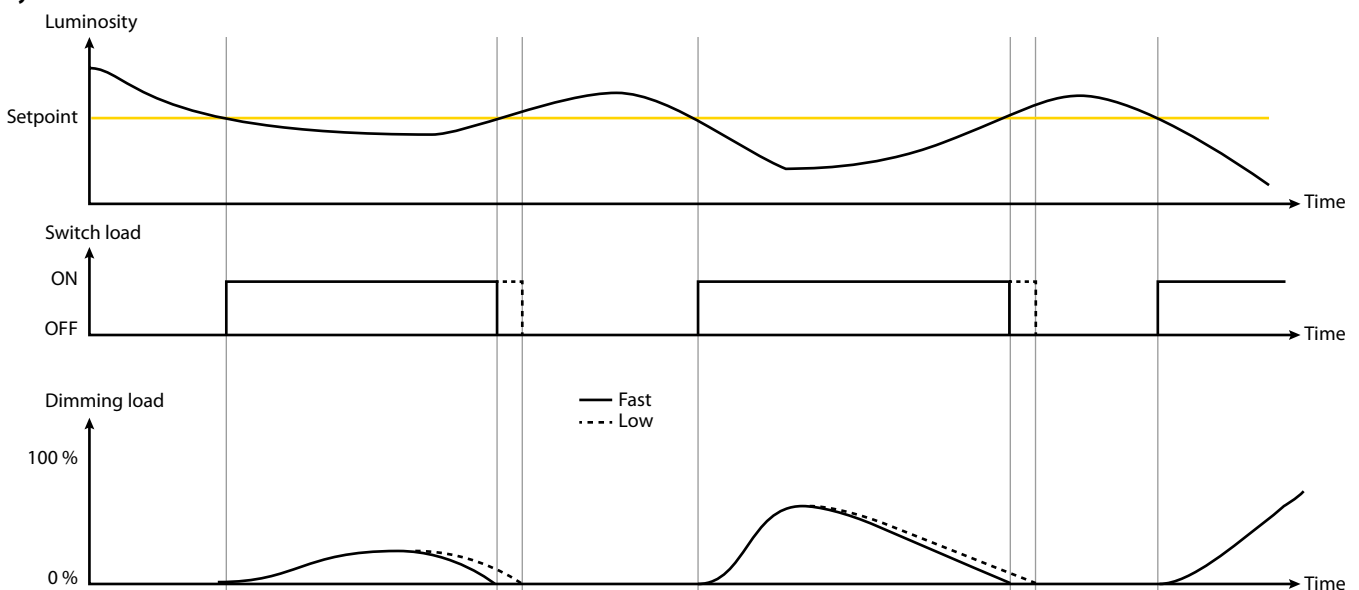

12. COMMUNICATION OBJECTS (continued)

12.2 General parameters (continued)

12.2.1 Main function - Master: Light level only (continued)

12.2.1.2 Mode: Manual ON/Auto OFF

| No. | Object name | Function | Size | Flags |
|-----|--------------------|--------------------|---------------------|-------|
| 13 | Synchro regulation | Synchro regulation | 1.010 DP_Start/stop | CW |

In Lux values are received via the group address linked to this object.
Start and stop can be configured in ETS.
Message start/stop régulation is received to this object.

| | | | | |
|----|-------------------|-------------------|---------------------|-----|
| 14 | Regulation status | Regulation status | 1.010 DP_Start/stop | CRT |
|----|-------------------|-------------------|---------------------|-----|

Regulation statuses are sent via the group address linked to this object

System behaviour:

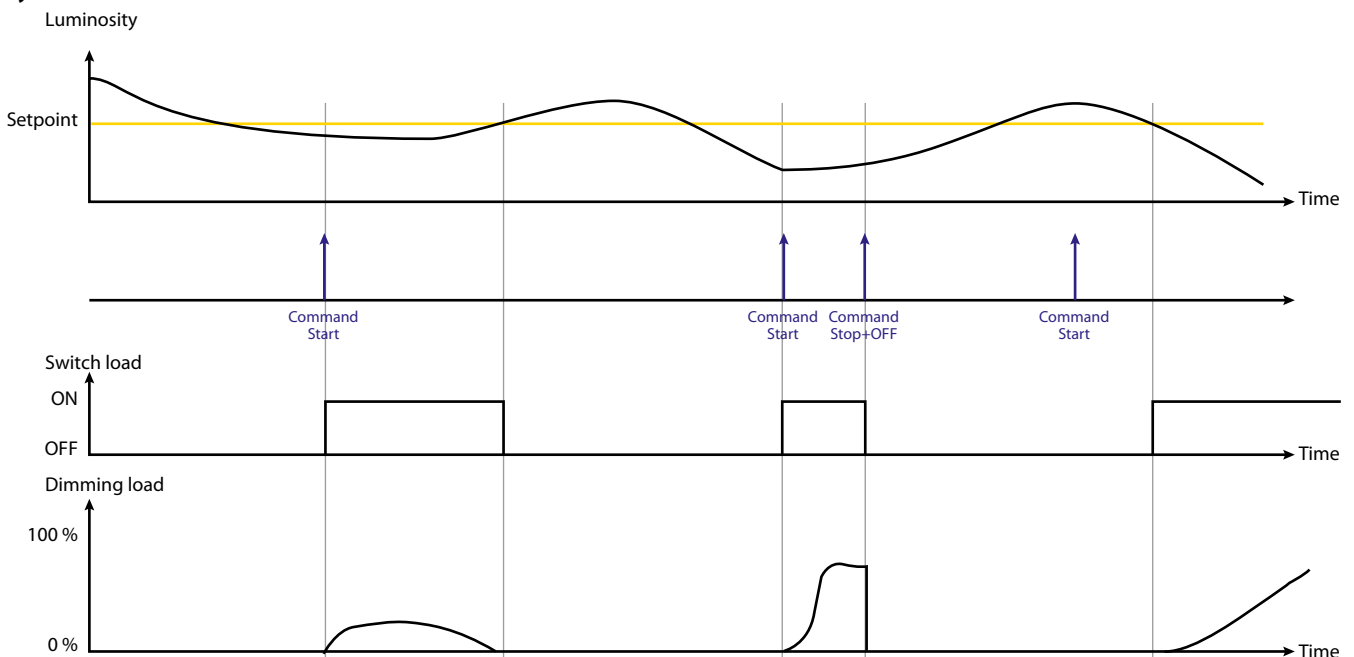

12. COMMUNICATION OBJECTS (continued)

■ **12.2 General parameters (continued)**

12.2.1 Main function - Master: Light level only (continued)

12.2.1.2 Mode: Manual ON/Auto OFF (continued)

| Parameters | Settings |
|---|---|
| Action on "Synchro regulation" object on start | Start regulation ON + Start regulation Stop regulation Stop regulation + ON Stop regulation + OFF No reaction |
| <p>This parameter determines the regulation reaction when Start received. <i>Start regulation:</i> Regulation is run with no action on load <i>ON + Start regulation:</i> Regulation is run with ON action on load <i>Stop regulation:</i> Regulation is stopped with no action on load <i>Stop regulation + ON:</i> Regulation is stopped with ON action on load <i>Stop regulation + OFF:</i> Regulation is stopped with OFF action on load <i>No reaction:</i> No reaction</p> | |
| Action on "Synchro regulation" object on stop | Start regulation ON + Start regulation Stop regulation Stop regulation + ON Stop regulation + OFF No reaction |
| <p>This parameter determines the regulation reaction when Stop received. <i>Start regulation:</i> Regulation is run with no action on load <i>ON + Start regulation:</i> Regulation is run with ON action on load <i>Stop regulation:</i> Regulation is stopped with no action on load <i>Stop regulation + ON:</i> Regulation is stopped with ON action on load <i>Stop regulation + OFF:</i> Regulation is stopped with OFF action on load <i>No reaction:</i> No reaction</p> | |
| Use scene | No Yes |
| <p>No: In scene regulation cannot be used, no accessible communication objects.</p> | |

• **Use scene → Yes**

| | |
|------------------------------|-------------|
| Use scene | Yes |
| Scene A number (0: not used) | 0 |
| Scene A action | No reaction |
| Scene B number (0: not used) | 0 |
| Scene B action | No reaction |
| Scene C number (0: not used) | 0 |
| Scene C action | No reaction |
| Scene D number (0: not used) | 0 |
| Scene D action | No reaction |
| Scene E number (0: not used) | 0 |
| Scene E action | No reaction |

12. COMMUNICATION OBJECTS (continued)

■ 12.2 General parameters (continued)

12.2.1 Main function - Master: Light level only (continued)

12.2.1.2 Mode: Manual ON/Auto OFF (continued)

- Use scene → Yes (continued)

When use scene is yes: this object communication is available.

| No. | Object name | Function | Size | Flags |
|-----|-------------------------|-------------------------|----------------------------|-------|
| 12 | In_scene_ regulation | In_scene_ regulation | 17.001 DP_Scene_ number | CW |

8-bit auxiliary telegrams are received via the group address linked to this object. On scene telegram you can start/stop régulation with on/off (mode manuel On/Auto Off).

| Parameters | Settings |
|---|---|
| Scene A to E number | 0-64 |
| This parameter determines which scene (1..64) is to be recalled. If value "0" is set, no scene will be recalled | |
| Scene A to E action | Start regulation ON + Start regulation Stop regulation Stop regulation + ON Stop regulation + OFF No reaction |

This parameter determines the regulation reaction when scene number is received.

Start regulation: Regulation is run with no action on load

ON + Start regulation: Regulation is run with ON action on load

Stop regulation: Regulation is stopped with no action on load

Stop regulation + ON: Regulation is stopped with ON action on load

Stop regulation + OFF: Regulation is stopped with OFF action on load

No reaction: No reaction

12. COMMUNICATION OBJECTS (continued)

12.2 General parameters (continued)

12.2.2 Main function - Master: Detection only

| Parameters | Settings |
|---------------|---|
| Main function | Master: Light level only Master: Detection only Master: Light level & detection Slave: Detection only |

Load, detection, early warning, AuxOutput and Advanced config can be configured in the various associated pages, and regulation is not active.

12.2.2.1 Mode: Auto ON/OFF

| Parameters | Settings |
|-------------------|------------------|
| Active regulation | Yes No |

No: No regulation possible

System behaviour:

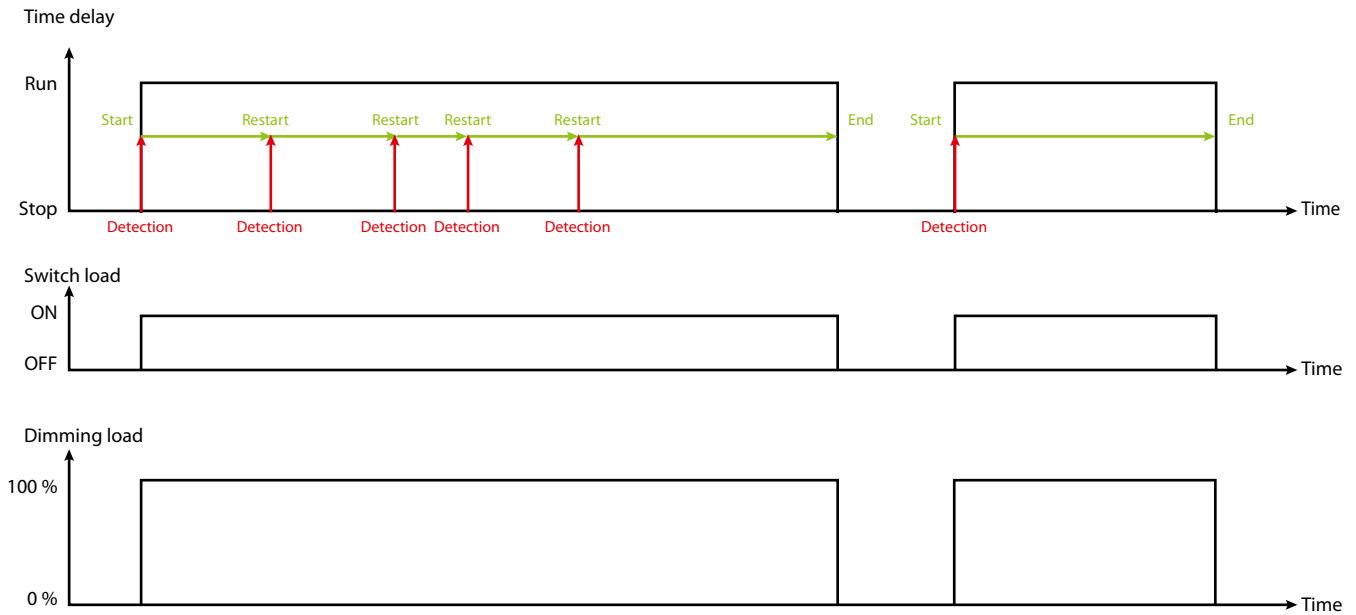

12. COMMUNICATION OBJECTS (continued)

12.2 General parameters (continued)

12.2.2 Main function - Master: Detection only (continued)

12.2.2.2 Mode: Manual ON/Auto OFF

| | | |
|--------------------|--------------------|-------------------------|
| General | Main function: | Master : Detection only |
| Load | Mode: | Manual ON/Auto OFF |
| Detection config. | Active regulation: | No |
| Auxiliary output | | |
| Advanced | | |
| ----- | | |
| Virtual keycard | | |
| Commissioning Tool | | |
| ----- | | |

| No. | Object name | Function | Size | Flags |
|-----|----------------|----------------|---------------------|-------|
| 13 | Synchro on/off | Synchro on/off | 1.010 DP_Start/stop | CW |

Synchro on/off statuses are received via the group address linked to this object.

| Parameters | Settings |
|-------------------|-----------|
| Active regulation | Yes No |

No: No regulation possible

System behaviour:

Time delay

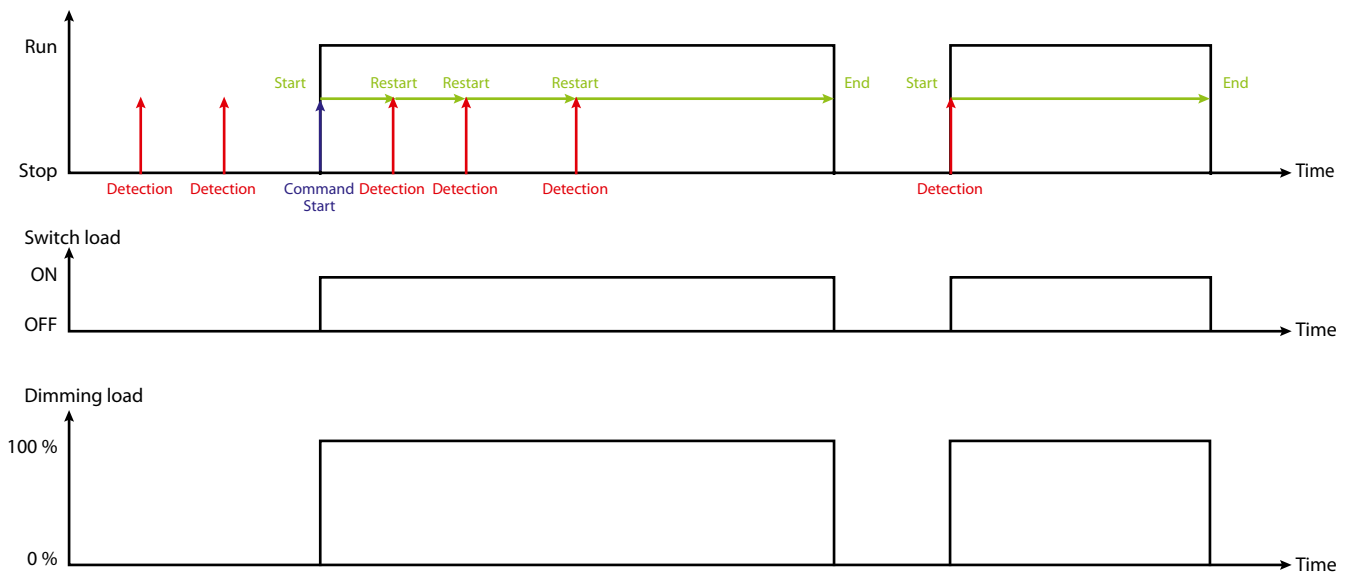

12. COMMUNICATION OBJECTS (continued)

12.2 General parameters (continued)

12.2.3 Main function - Master: Light level & Detection

| Parameters | Settings |
|---------------|---|
| Main function | Master: Light level only Master: Detection only Master: Light level & detection Slave: Detection only |

Load, light level, detection, early warning, AuxOutput and Advanced config can be configured in the various associated pages.

12.2.3.1 Mode: Auto ON/OFF

The system runs automatically.



| Parameters | Settings |
|-------------------|------------------|
| Active regulation | Yes No |

No: No regulation possible

Yes: The cell in the sensor will switch ON/OFF or dim its associated loads according to variations in the natural light

System behaviour:

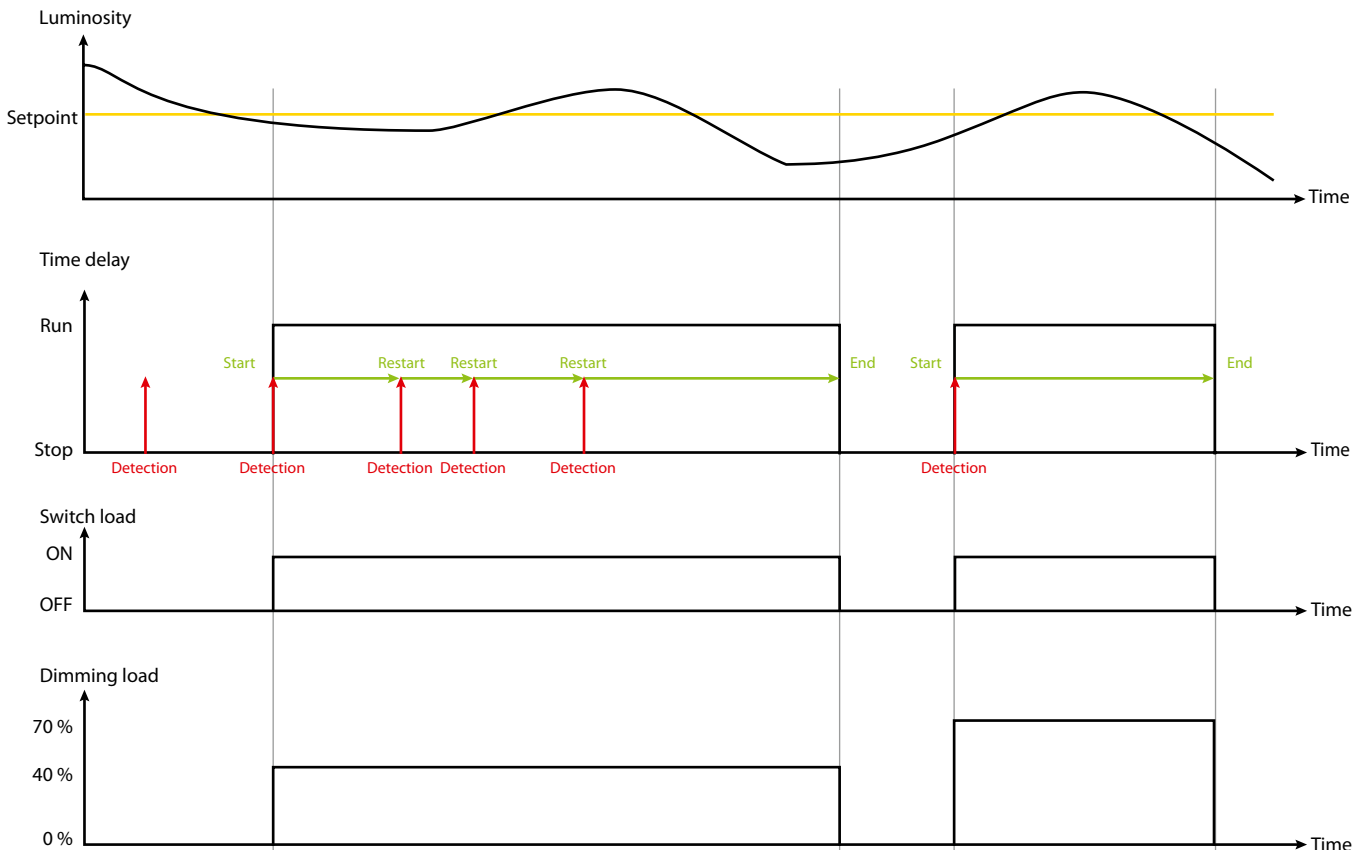

12. COMMUNICATION OBJECTS (continued)

■ **12.2 General parameters (continued)**

12.2.3 Main function - Master: Light level & Detection (continued)

12.2.3.1 Mode: Auto ON/OFF(continued)

| Parameters | Settings |
|--------------------------|------------------|
| Active regulation | Yes No |

No: No regulation possible

Yes: The cell in the sensor will switch ON/OFF or dim its associated loads according to variations in the natural light

| | |
|-----------------------|---|
| Reaction speed | Very Low Low Normal Fast Very Fast |
|-----------------------|---|

This parameter determines the speed reaction of the regulation in dimming or switching

When active régulation is yes: this object communication is available.

| No. | Object name | Function | Size | Flags |
|-----|---------------------|---------------------|-----------------|-------|
| 10 | In_Detection_enable | In_Detection_enable | 1.003 DP_Enable | CRW |

In detection enable statuses are received via the group address linked to this object.

Enable: The sensor is in Light level & detection mode

Disable: The sensor is in light level only mode

Used to enable/disable the DETECTION ONLY, by a control schedule for example.

12. COMMUNICATION OBJECTS (continued)

12.2 General parameters (continued)

12.2.3 Main function - Master: Light level & Detection (continued)

12.2.3.1 Mode: Auto ON/OFF(continued)

System behaviour:

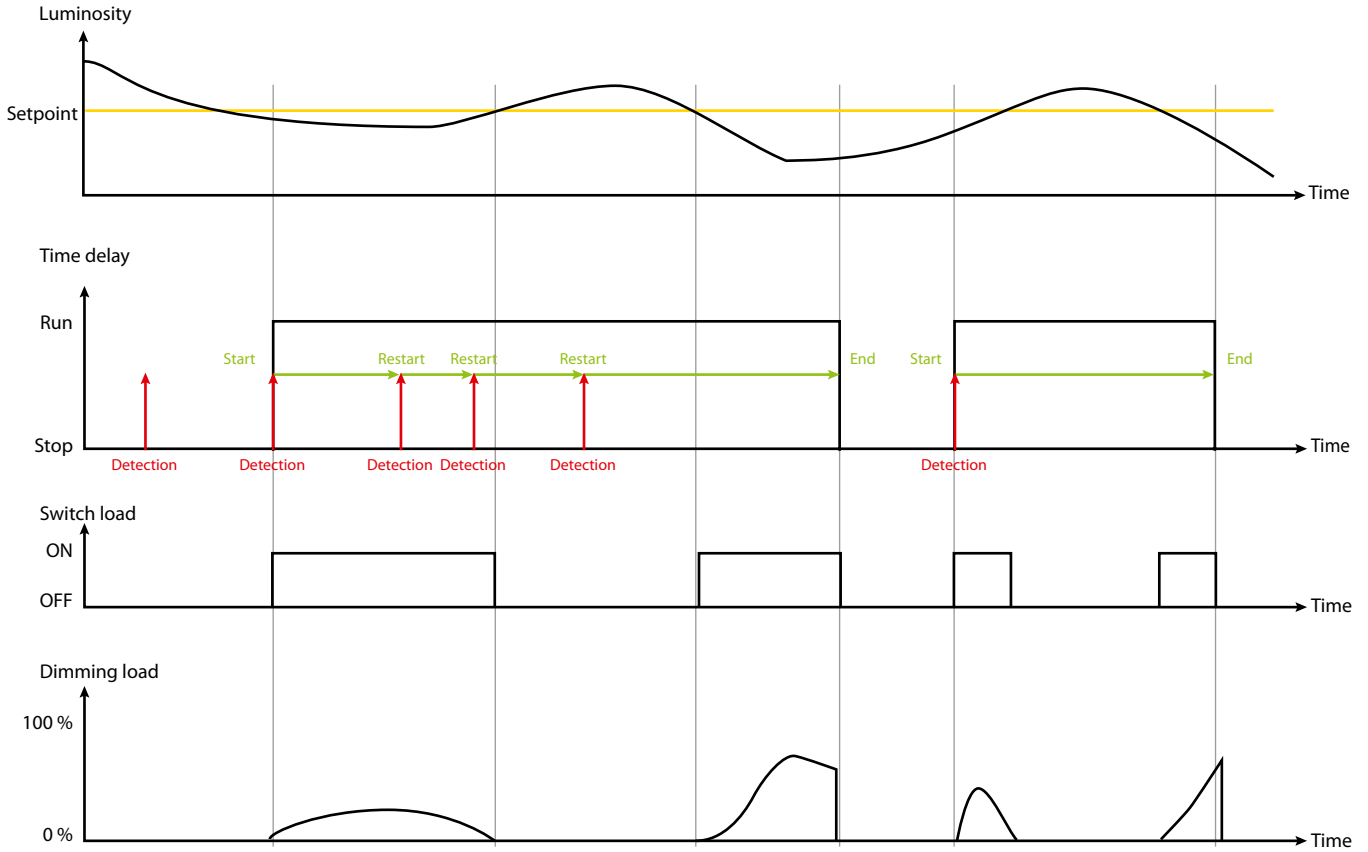

12.2.3.2 Mode: AUTO Walkthrough

| | |
|--|--|
| <ul style="list-style-type: none"> General Load Light level config. Detection config. Auxiliary output Advanced ----- Virtual keycard Commissioning Tool ----- | <p>Main function: Master : Light level & detection</p> <p>Mode: Auto Walkthrough</p> <p>Active regulation: Yes</p> <p>Reaction speed: Normal</p> |
|--|--|

| Parameters | Settings |
|--|---|
| Active regulation | Yes No |
| <p>No: No regulation possible Yes: The cell in the sensor will switch ON/OFF or dim its associated loads according to variations in the natural light</p> | |
| Reaction speed | Very Low Low Normal Fast Very Fast |
| <p>This parameter determines the speed reaction of the regulation in dimming or switching</p> | |

12. COMMUNICATION OBJECTS (continued)

12.2 General parameters (continued)

12.2.3 Main function - Master: Light level & Detection (continued)

12.2.3.3 Mode: Manual On/Auto Off

The system runs with manual operation.



| No. | Object name | Function | Size | Flags |
|-----|----------------|----------------|---------------------|-------|
| 13 | Synchro on/off | Synchro on/off | 1.010 DP_Start/stop | CW |

Synchro on/off statuses are received via the group address linked to this object

| Parameters | Settings |
|-------------------|-----------|
| Active regulation | Yes No |

No: No regulation possible

Yes: The cell in the sensor will switch ON/OFF or dim its associated loads according to variations in the natural light

System behaviour:

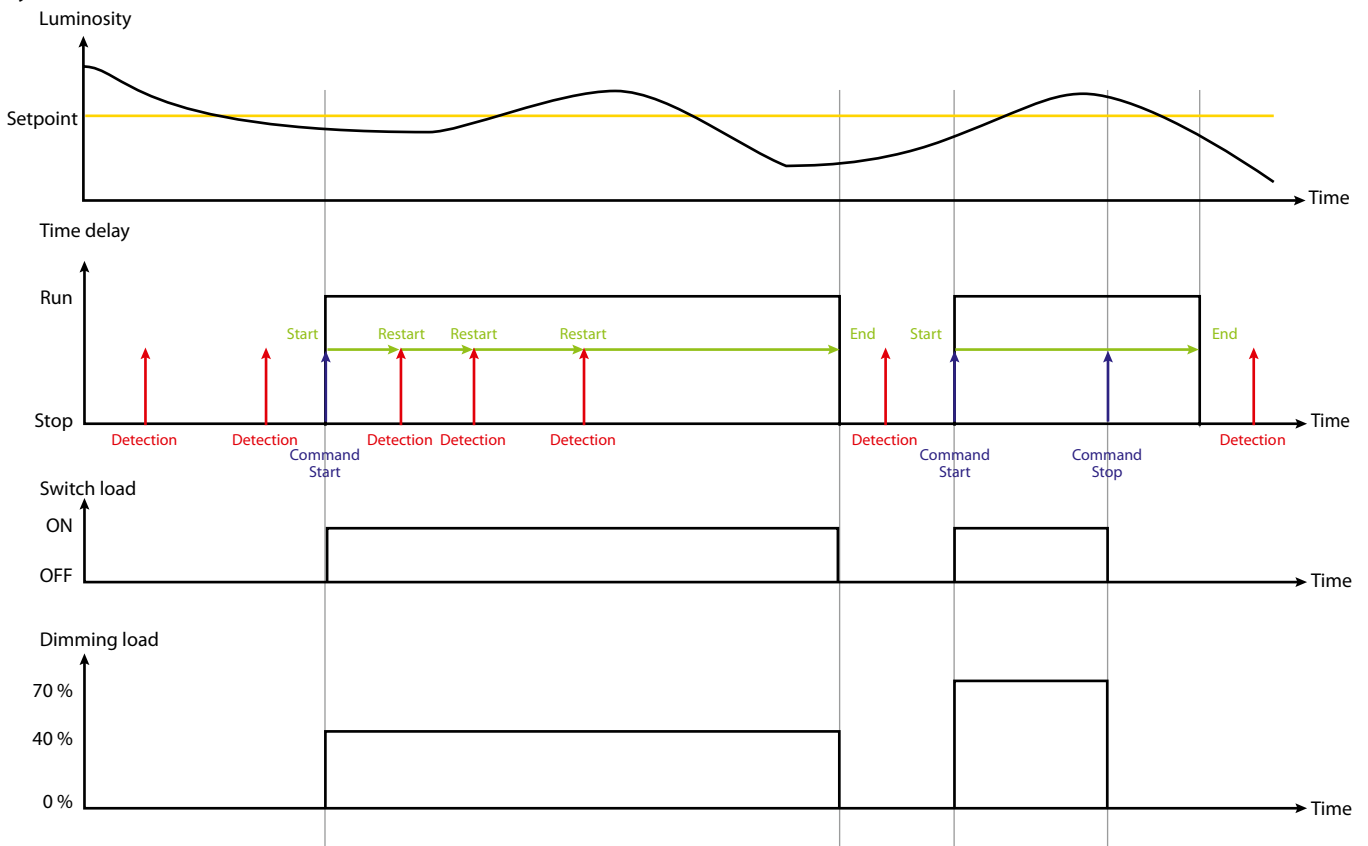

12. COMMUNICATION OBJECTS (continued)

■ **12.2 General parameters (continued)**

12.2.3 Main function - Master: Light level & Detection (continued)

12.2.3.3 Mode: Manual On/Auto Off (continued)

| | | |
|---------------------|--|----------------------------------|
| General | Main function | Master : Light level & detection |
| Load | Mode | Manual ON/Auto OFF |
| Light level config. | Active regulation | Yes |
| Detection config. | Reaction speed | Normal |
| Auxiliary output | Action on "Synchro regulation" object on start | ON + Start regulation |
| Advanced | Action on "Synchro regulation" object on stop | Stop regulation + OFF |
| ----- | Use scene | No |
| Virtual keycard | | |
| Commissioning Tool | | |
| ----- | | |

| Parameters | Settings |
|-------------------|-----------|
| Active regulation | Yes No |

No: No regulation possible

Yes: The cell in the sensor will switch ON/OFF or dim its associated loads according to variations in the natural light

When active régulation is yes: this object communication is available.

| No. | Object name | Function | Size | Flags |
|-----|--------------------|--------------------|---------------------|-------|
| 13 | Synchro regulation | Synchro regulation | 1.010 DP_Start/stop | CW |

In Lux statuses are received via the group address linked to this object.
Start and stop can be configured in ETS.

| | | | | |
|----|-------------------|-------------------|---------------------|-----|
| 14 | Regulation status | Regulation status | 1.010 DP_Start/stop | CRT |
|----|-------------------|-------------------|---------------------|-----|

Regulation statuses are sent via the group address linked to this object

12. COMMUNICATION OBJECTS (continued)

■ 12.2 General parameters (continued)

12.2.3 Main function - Master: Light level & Detection (continued)

12.2.3.3 Mode: Manual On/Auto Off (continued)

System behaviour:

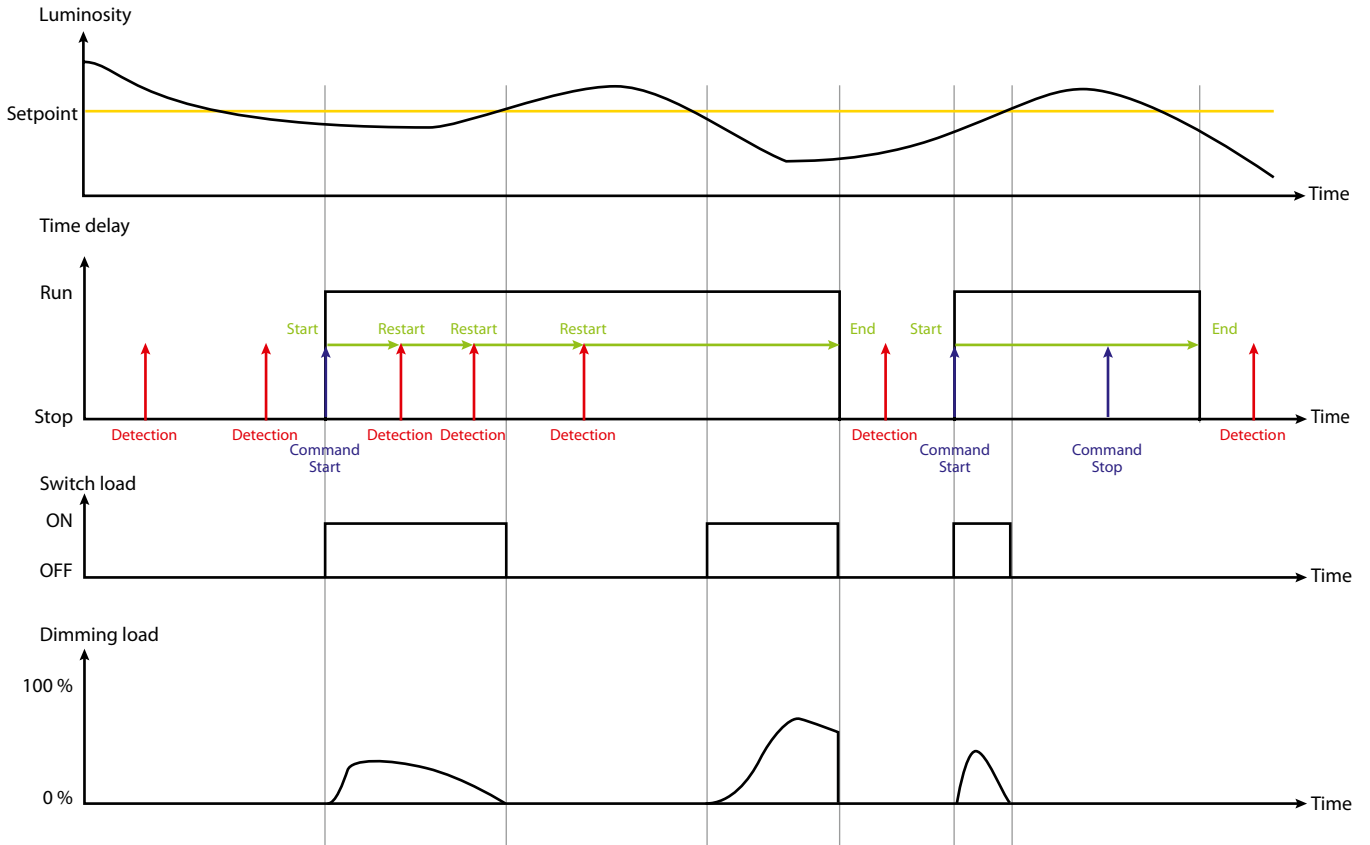

12. COMMUNICATION OBJECTS (continued)**■ 12.2 General parameters (continued)****12.2.3 Main function - Master: Light level & Detection (continued)****12.2.3.3 Mode: Manual On/Auto Off (continued)**

| Parameters | Settings |
|----------------|---|
| Reaction speed | Very Low Low Normal Fast Very Fast |

This parameter determines the speed reaction of the regulation in dimming or switching

| Action on "Synchro regulation" object on start | Start regulation |
|--|--|
| | ON + Start regulation Stop regulation Stop regulation + ON Stop regulation + OFF No reaction |

This parameter determines the regulation reaction when Start received.

Start regulation: Regulation is run with no action on load

ON + Start regulation: Regulation is run with ON action on load

Stop regulation: Regulation is stopped with no action on load

Stop regulation + ON: Regulation is stopped with ON action on load

Stop regulation + OFF: Regulation is stopped with OFF action on load

No reaction: No reaction

| Action on "Synchro regulation" object on stop | Start regulation |
|---|--|
| | ON + Start regulation Stop regulation Stop regulation + ON Stop regulation + OFF No reaction |

This parameter determines the regulation reaction when Stop received.

Start regulation: Regulation is run with no action on load

ON + Start regulation: Regulation is run with ON action on load

Stop regulation: Regulation is stopped with no action on load

Stop regulation + ON: Regulation is stopped with ON action on load

Stop regulation + OFF: Regulation is stopped with OFF action on load

No reaction: No reaction

| Use scene | No Yes |
|-----------|-----------|
| | |

No: In scene regulation cannot be used, no accessible communication objects.

12. COMMUNICATION OBJECTS (continued)

■ 12.2 General parameters (continued)

12.2.3 Main function - Master: Light level & Detection (continued)

12.2.3.3 Mode: Manual On/Auto Off (continued)

• Use scene → Yes

| | |
|------------------------------|-------------|
| Use scene | Yes |
| Scene A number (0: not used) | 0 |
| Scene A action | No reaction |
| Scene B number (0: not used) | 0 |
| Scene B action | No reaction |
| Scene C number (0: not used) | 0 |
| Scene C action | No reaction |
| Scene D number (0: not used) | 0 |
| Scene D action | No reaction |
| Scene E number (0: not used) | 0 |
| Scene E action | No reaction |

When use scene is yes: this object communication is available.

| No. | Object name | Function | Size | Flags |
|-----|---------------------|---------------------|------------------------|-------|
| 12 | In_scene_regulation | In_scene_regulation | 17.001 DP_Scene_number | CW |

8-bit auxiliary telegrams are received via the group address linked to this object

| Parameters | Settings |
|--|---|
| Scene A to E number This parameter determines which scene (1..64) is to be recalled. If value "0" is set, no scene will be recalled | 0-64 |
| Scene A to E action This parameter determines the regulation reaction when scene number is received. <i>Start regulation:</i> Regulation is run with no action on load <i>ON + Start regulation:</i> Regulation is run with ON action on load <i>Stop regulation:</i> Regulation is stopped with no action on load <i>Stop regulation + ON:</i> Regulation is stopped with ON action on load <i>Stop regulation + OFF:</i> Regulation is stopped with OFF action on load <i>No reaction:</i> No reaction | Start regulation ON + Start regulation Stop regulation Stop regulation + ON Stop regulation + OFF No reaction |

12. COMMUNICATION OBJECTS (continued)

■ 12.2 General parameters (continued)

12.2.4 Slave: Detection only

| Parameters | Settings |
|---------------|---|
| Main function | Master: Light level only Master: Detection only Master: Light level & detection Slave: Detection only |

You can configure the detection, Advance config in the different page associated, and regulation is not active. You can associate the sensors with the sensor master to extend the detection zone, see the configuration § 13.5.



12. COMMUNICATION OBJECTS (continued)

■ 12.3 Load

Page only available for Master: Light level Only, Master: Detection Only and Master: Light level & Detection modes.

| No. | Object name | Function | Size | Flags |
|-----|-------------|-----------|-----------------|-------|
| 1 | Switching | Switching | 1.001 DP_On/Off | CT |

Switching telegrams are sent via the group address linked to this object

| | | | | |
|---|------------------|------------------|-----------------|------|
| 2 | Switching Status | Switching Status | 1.001 DP_On/Off | CWTU |
|---|------------------|------------------|-----------------|------|

Switching statuses are received via the group address linked to this object.

*If switching statuses are received but the Switching object has not been sent by the sensor, the regulation is stopped.

12.3.1 Use dimming load

| Parameters | Settings |
|------------------|-----------|
| Use dimming load | Yes No |

No: Level, level status and In_Sync_Dim cannot be used, no accessible communication objects

| No. | Object name | Function | Size | Flags |
|-----|-------------|----------|---------------------|-------|
| 3 | Level | Level | 5.001 DP Percentage | CT |

Level telegrams are sent via the group address linked to this object

| | | | | |
|---|--------------|--------------|---------------------|------|
| 4 | Level status | Level status | 5.001 DP Percentage | CWTU |
|---|--------------|--------------|---------------------|------|

Level statuses are received via the group address linked to this object.

*If Level statuses are received but the Level object has not been sent by the sensor, the regulation is stopped.

| | | | | |
|---|--------------------|--------------------|--------------------------|----|
| 9 | In Synchro dimming | In Synchro dimming | 3.007 DP_dimming control | CW |
|---|--------------------|--------------------|--------------------------|----|

In override dimming values are received via the group address linked to this object. Any value received on this object is considered to be an override.

12. COMMUNICATION OBJECTS (continued)

■ **12.3 Load (continued)**

12.3.2 Use expert parameters

Parameters only available for Master Light level Only and Master Light level & Detection modes.

| Parameters | Settings |
|-------------------------------------|-----------|
| Dimming expert configuration | Yes No |

No: Use for the current load type

When dimming expert configuration is yes: this object communication is available.

| No. | Object name | Function | Size | Flags |
|-----|---------------------|---------------------|---------------------|-------|
| 24 | Syncro_MinimumLevel | Syncro_MinimumLevel | 5.001 DP Percentage | CRW |

Syncro_MinimumLevel values are received via the group address linked to this object

| Parameters | Settings |
|---|---|
| Minimum level This parameter determines the minimum level of the actuator | 0-100 |
| Maximum level This parameter determines the maximum level of the actuator | 0-100 |
| Time from Off state to On (100%) state This parameter determines the time (in seconds) for the actuator to change from OFF to ON (0% to 100%) | 1-60 |
| Load curve This parameter determines the response curve of the actuator | Linear Type 1 (DALI) Custom Reserved Reserved |

12. COMMUNICATION OBJECTS (continued)

■ **12.3 Load (continued)**

12.3.3 Standby time base (function only available in Master mode: detection and Master: Light level & Detection)

Parameters only available for Master Light level Only and Master Light level & Detection modes.

• **Standby configuration :**

You alert the user to the switch off the light: after the last detection (plus detection time delay) you can reduce the level of light.

| Parameters | Settings |
|-------------------|--|
| Standby time base | Disable Infinite Seconds Minutes |

Disable: Standby is not active

Infinite: At the end of time delay the load decreases to standby level for an infinite time

Seconds: At the end of time delay the load decreases to standby level for the standby time in seconds

Minutes: At the end of time delay the load decreases to standby level for the standby time in minutes

The screenshot shows the configuration interface for a KNX ceiling sensor. The left sidebar contains the following menu items: General, Load (selected), Light level config., Detection config., Auxiliary output, Advanced, -----, Virtual keycard, Commissioning Tool, -----. The main configuration area is divided into several sections:

- Use dimming load:** Yes
- Dimming expert configuration:**
 - Use expert parameters: Yes
 - Minimum level: 10
 - Maximum level: 100
 - Time from Off to On (100%) state: 5
 - Load curve: Linear
- Standby configuration:**
 - Standby time base: Minutes
 - Delay: 1
 - Standby Level (%): 10
- Use second load:** No

12. COMMUNICATION OBJECTS (continued)**■ 12.3 Load (continued)****12.3.3 Standby time base (function only available in Master mode: detection and Master: Light level & Detection) (continued)****• Standby time base → Seconds**

A standby function, in seconds, is used. At the end of time delay the load decreases to standby level for the standby time in seconds.

| Parameters | Settings |
|---|----------|
| Delay | 0-60 |
| This parameter determines the time for the standby in seconds | |
| Standby level | 0-100 |
| This parameter determines the standby level (default value 10%) | |

• Standby time base → Minutes

A standby function, in minutes, is used. At the end of time delay the load decreases to standby level for the standby time in minutes.

| Parameters | Settings |
|---|----------|
| Delay | 0-60 |
| This parameter determines the time for the standby in minutes | |
| Standby level | 0-100 |
| This parameter determines the standby level (default value 10%) | |

• Standby time base → Infinite

An infinite standby function is used. At the end of time delay the load decreases to standby level for an infinite time.

| Parameters | Settings |
|---|----------|
| Standby level | 0-100 |
| This parameter determines the standby level (default value 10%) | |

12. COMMUNICATION OBJECTS (continued)

■ **12.3 Load (continued)**

12.3.4 Use second load

| Parameters | Settings |
|-----------------|-----------|
| Use second load | Yes No |

No: Switching second light and level second light cannot be used, no accessible communication objects

The screenshot shows the configuration interface for the 'Load' parameter. On the left is a navigation menu with options: General, Load (selected), Light level config., Detection config., Auxiliary output, Advanced, -----, Virtual keycard, and Commissioning Tool. The main area is divided into sections:

- Dimming expert configuration:**
 - Use expert parameters: Yes (dropdown)
 - Minimum level: 10 (input field)
 - Maximum level: 100 (input field)
 - Time from Off to On (100%) state: 5 (input field)
 - Load curve: Linear (dropdown)
- Standby configuration:**
 - Standby time base: Minutes (dropdown)
 - Delay: 1 (input field)
 - Standby Level (%): 10 (input field)
- Use second load:** Yes (dropdown)
- Offset sign:** Negative (-) (dropdown)
- Offset (%):** 0 (input field)

When use second load is yes: this object communication is available.

| No. | Object name | Function | Size | Flags |
|-----|------------------------|------------------------|-----------------|-------|
| 22 | Switching second light | Switching second light | 1.001 DP_On/Off | CRT |

Switching second light telegrams are sent via the group address linked to this object. Used to pilot on On/Off 2nd light with an offset compared to 1st load.

| 23 | Level second light | Level second light | 5.001 DP Percentage | CRT |
|----|--------------------|--------------------|---------------------|-----|
|----|--------------------|--------------------|---------------------|-----|

Level second light telegrams are sent via the group address linked to this object. Used to pilot on dimming 2nd light with an offset compared to 1st load.

| Parameters | Settings |
|-------------|----------------------|
| Offset sign | Negative Positive |

This parameter determines the sign of the offset value

| | |
|------------|-------|
| Offset (%) | 0-100 |
|------------|-------|

This parameter determines the offset value

12. COMMUNICATION OBJECTS (continued)

■ **12.4 Light level config**

Page only available for Master: Light level Only and Master: Light level & Detection modes.

| Parameters | Settings |
|-----------------|-------------------------------------|
| Setpoint | 0 Lux... 100 Lux ...1275 Lux |

This parameter represents the set luminosity threshold to be maintained. It is expressed in Lux

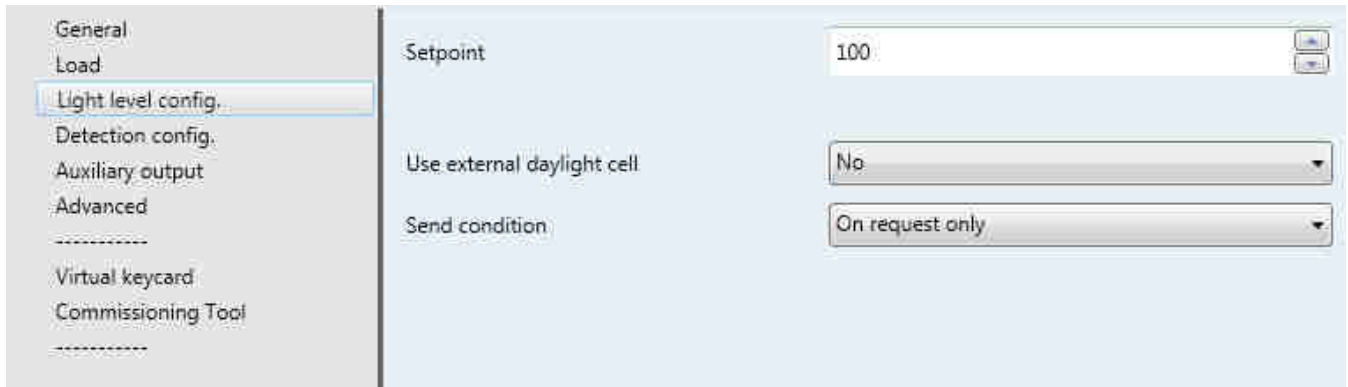

12.4.1 Use external daylight cell

For light régulation you choose if you use lux value measured by the sensor (No) or you can use an external daylight cell (Yes) see below.

| Parameters | Settings |
|-----------------------------------|---|
| Use external daylight cell | No Yes |
| Send condition | On request only On change Cyclical On change + Cyclical |

On request only: The object value is updated but not sent
On change: The object value is sent when it changes
Cyclical: The object value is sent cyclically
On change + Cyclical: The object value is sent when it changes and cyclically

| No. | Object name | Function | Size | Flags |
|-----|-------------|----------|--------------|-------|
| 8 | Out Lux | Out Lux | 9.004 DP_Lux | CRT |

Out Lux values are sent via the group address linked to this object.
 Send operations can be set in ETS (Cyclical, on change, on request)

12. COMMUNICATION OBJECTS (continued)**■ 12.4 Light level config (continued)****12.4.1 Use external daylight cell (continued)****On change**

| Parameters | Settings |
|--|----------|
| Max. number of messages per minute | 1-60 |
| This parameter determines the maximum number of messages per minute | |
| Dead band | 1-100 |
| This parameter determines the percentage variation for validating a change | |

Cyclical

The object value is sent cyclically

| Parameters | Settings |
|---|----------|
| Cyclical interval (seconds) | 1-255 |
| This parameter determines the timebase for sending lux in seconds | |

On change + Cyclical

| Parameters | Settings |
|--|----------|
| Cyclical interval (seconds) | 1-255 |
| This parameter determines the timebase for sending lux in seconds | |
| Max. number of messages per minute | 1-60 |
| This parameter determines the maximum number of messages per minute. The value must be higher than the timebase/60. | |
| Dead band | 1-100 |
| This parameter determines the percentage variation for validating a change | |

When use external daylight cell is yes: this object communication is available.

| No. | Object name | Function | Size | Flags |
|-----|-------------|----------|--------------|-------|
| 7 | In Lux | In Lux | 9.004 DP_Lux | CW |

In Lux values are received via the group address linked to this object.
The sensor reacts as if it had an internal daylight cell

Warning: When an external daylight cell is used, the provision of light must be set with the IR commissioning tool.

12. COMMUNICATION OBJECTS (continued)

■ 12.5 Detection config

Page only available for Master Detection Only and Master Light level & Detection modes.

| No. | Object name | Function | Size | Flags |
|-----|--------------|--------------|---------------|-------|
| 5 | In Occupancy | In Occupancy | 1.002 DP_Bool | CW |

In Occupancy statuses are received via the group address linked to this object.
 True: The sensor reacts as if there was an internal detection
 False: No reaction

| | | | | |
|---|---------------|---------------|---------------|-----|
| 6 | Out Occupancy | Out Occupancy | 1.002 DP_Bool | CRT |
|---|---------------|---------------|---------------|-----|

Out Occupancy statuses are sent via the group address linked to this object
 True: When motion detected
 False: After vacancy time delay, or occupancy if vacancy is not used

| | | | | |
|----|-------------------------------|-------------------------------|---------------|----|
| 20 | Out Synchro Master → Slave | Out Synchro Master → Slave | 1.002 DP_Bool | CT |
|----|-------------------------------|-------------------------------|---------------|----|

Out synchro Master-> Slave statuses are sent via the group address linked to this object
 True: The maintain status is sent to the slave
 False: The initial status is sent to the slave

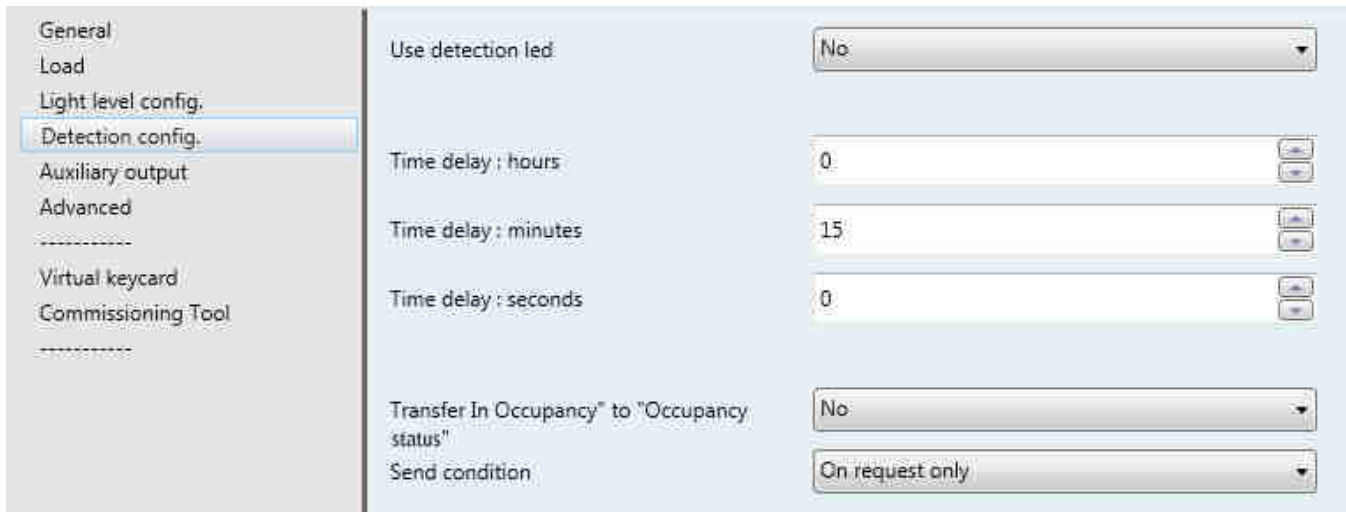

| Parameters | Settings |
|---|-----------|
| Use detection LED | Yes No |
| This parameter determines whether or not the detection LED is to be used when detection is active | |
| Time delay: hours | 0-17 |
| This parameter determines the hours of the time delay | |
| Time delay: minutes | 0-59 |
| This parameter determines the minutes of the time delay | |
| Time delay: seconds | 0-59 |
| This parameter determines the seconds of time delay. If the total value is less than 5 s the time delay is automatically set to 5 s | |
| Transfer In Occupancy to "Occupancy Status" | Yes No |
| This parameter determines how many "presence events" are transmitted on the bus. Is "yes" the presence events of all sensors being part of the master-slave configuration are passed on the KNX/BUS; This configuration is useful for an external supervisor. If "no" only the presence event of the master sensor is passed on the KNX/BUS Yes: you have the occupancy status for each sensors : master and slaves .usefull for exampmple in supervision No: you have one occupancy status for all sensors of the detection zone.You can use it to pilot a corridor for example. | |

12. COMMUNICATION OBJECTS (continued)

■ **12.5 Detection config (continued)**

12.5.1 Send Condition

Page only available for Slave Detection Only mode.

| Parameters | Settings |
|-----------------------|---|
| Send condition | On request only On change Cyclical On change + Cyclical |

On request only: The object value is updated but not sent
On change: The object value is sent when it changes
Cyclical: The object value is sent cyclically
On change + Cyclical: The object value is sent when it changes and cyclically

On request only

The object value is updated but not sent

On change

The object value is sent when detection is validated

| Parameters | Settings |
|---|----------|
| Max. number of messages per minute | 1-60 |

This parameter determines the maximum number of messages per minute

Cyclical

The object value is sent cyclically

| Parameters | Settings |
|------------------------------------|----------|
| Cyclical interval (seconds) | 1-255 |

This parameter determines the timebase for sending lux in seconds

On change + Cyclical

| Parameters | Settings |
|------------------------------------|----------|
| Cyclical interval (seconds) | 1-255 |

This parameter determines the timebase for sending lux in seconds

| | |
|---|------|
| Max. number of messages per minute | 1-60 |
|---|------|

This parameter determines the maximum number of messages per minute.
 The value must be higher than the timebase/60.

12. COMMUNICATION OBJECTS (continued)

12.6 Auxiliary output

Page only available for Master: Detection Only, Master: Light level & Detection and Slave: Detection Only modes

| Parameters | Settings |
|-----------------------|---|
| Auxiliary object type | None Switching Scaled value HVAC Mode Scene 2 bytes value |

12.6.1 None

The auxiliary output cannot be used, no accessible communication objects.

12.6.2 Switching

| No. | Object name | Function | Size | Flags |
|-----|---------------------|---------------------|-----------------|-------|
| 11 | Switching Auxiliary | Switching Auxiliary | 1.001 DP_On/Off | CT |

Switching Auxiliary telegrams are sent via the group address linked to this object

| Parameters | Settings |
|--|------------------|
| Send on Occupancy | Yes No |
| This parameter determines the reaction of the auxiliary on occupancy | |
| Value | On Off |
| This parameter determines the value to send on occupancy | |
| Send on Vacancy | Yes No |
| This parameter determines the reaction of the auxiliary on vacancy | |
| Value | On Off |
| This parameter determines the value to send on occupancy | |

12. COMMUNICATION OBJECTS (continued)

■ **12.6 Auxiliary output (continued)**

12.6.3 Scaled values

| No. | Object name | Function | Size | Flags |
|-----|-------------------|-------------------|------------------|-------|
| 11 | Scaling Auxiliary | Scaling Auxiliary | 5.001 DP_Scaling | CW |

Scaling Auxiliary telegrams are sent via the group address linked to this object

| Parameters | Settings |
|--|-----------|
| Send on Occupancy This parameter determines the reaction of the auxiliary on occupancy | Yes No |
| Value This parameter determines the value to send on occupancy | 0-100 |
| Send on vacancy This parameter determines the reaction of the auxiliary on vacancy | Yes No |
| Value This parameter determines the value to send on vacancy | 0-100 |

12. COMMUNICATION OBJECTS (continued)

■ **12.6 Auxiliary output (continued)**

12.6.4 HVAC Mode

| | | |
|---------------------|-----------------------|-----------|
| General | Auxiliary object type | HVAC Mode |
| Load | Send on occupancy | Yes |
| Light level config. | Value | 0 |
| Detection config. | Send on vacancy | Yes |
| Auxiliary output | Value | 0 |
| Advanced | | |
| ----- | | |
| Virtual keycard | | |
| Commissioning Tool | | |
| ----- | | |

| No. | Object name | Function | Size | Flags |
|-----|-------------|-----------|------------------------|-------|
| 11 | HVAC Mode | HVAC Mode | 20.102 DP_ HVACMode | CW |

Percent auxiliary telegrams are sent via the group address linked to this object

| Parameters | Settings |
|--|-----------|
| Send on Occupancy | Yes No |
| This parameter determines the reaction of the auxiliary on occupancy | |
| Value | 0-255 |
| This parameter determines the value to send on occupancy | |
| Send on vacancy | Yes No |
| This parameter determines the reaction of the auxiliary on vacancy | |
| Value | 0-255 |
| This parameter determines the value to send on vacancy | |

12. COMMUNICATION OBJECTS (continued)

■ **12.6 Auxiliary output (continued)**

12.6.5 Scene

| No. | Object name | Function | Size | Flags |
|-----|--------------------------|--------------------------|---------------------------|-------|
| 11 | 8-bit scene Auxiliary | 8-bit scene Auxiliary | 17.001 DP_ SceneNumber | CW |

8-bit scene auxiliary telegrams are sent via the group address linked to this object

| Parameters | Settings |
|--|-----------|
| Send on Occupancy | Yes No |
| This parameter determines the reaction of the auxiliary on occupancy | |
| Value | 1-64 |
| This parameter determines which scene (1..64) to send on occupancy. If value "0" is set, no scene will be recalled. | |
| Send on vacancy | Yes No |
| This parameter determines the reaction of the auxiliary on vacancy | |
| Value | 1-64 |
| This parameter determines which scene (1..64) to send on vacancy. If value "0" is set, no scene will be recalled. | |

12. COMMUNICATION OBJECTS (continued)

■ 12.6 Auxiliary output (continued)

12.6.6 2 bytes value

| No. | Object name | Function | Size | Flags |
|-----|---------------------------|---------------------------|---------------------|-------|
| 11 | 2-byte unsigned Auxiliary | 2-byte unsigned Auxiliary | 9.001 DP_Value_Temp | CRT |

2-bytet unsigned auxiliary telegrams are sent via the group address linked to this object

| Parameters | Settings |
|--|-----------|
| Send on Occupancy | Yes No |
| This parameter determines the reaction of the auxiliary on occupancy | |
| Value | 0-65535 |
| This parameter determines the value to send on occupancy | |
| Send on vacancy | Yes No |
| This parameter determines the reaction of the auxiliary on vacancy | |
| Value | 0-65535 |
| This parameter determines the value to send on vacancy | |

12. COMMUNICATION OBJECTS (continued)

■ **12.7 Advanced**

Page only available for Master: Detection Only, Master: Light level Only and Master: Light level & Detection modes.

12.7.1 Sensitivity (only available for Master: Detection Only, Master: Light level & Detection and Slave: Detection Only modes)

| Parameters | Settings |
|---|---|
| US sensitivity | Low Medium High Very high |
| This parameter determines the sensitivity of ultrasound sensors | |
| PIR sensitivity | Low Medium High Very high |
| This parameter determines the sensitivity of PIR sensors | |

12.7.2 System detection (only available for Master: Detection Only, Master: Light level & Detection and Slave: Detection Only modes)

| Parameters | Settings |
|---|---|
| Initial scheme | PIR only US only PIR and US PIR or US |
| This parameter determines the sensor detection system for initialising motion detection | |
| Maintain scheme | PIR only US only PIR and US PIR or US |
| This parameter determines the sensor detection system for maintaining motion detection | |

12. COMMUNICATION OBJECTS (continued)

■ 12.8 Advanced (continued)

12.7.3 Additional object for expert mode

Here should be explained the 2 objects "Additional object: setpoint" and "Additional object: Time delay"

With these 2 "Additional object, you change parameters setpoint and Time delay" of the sensors by a supervisor for example.

| Parameters | Settings |
|---|------------------|
| Additional Object: setpoint | No Yes |
| No: Additional object cannot be used, no accessible communication objects | |
| Additional Object: Timedelay | No Yes |
| No: Additional object cannot be used, no accessible communication objects | |

When additional object setpoint and time delay is yes: this object communication is available.

| No. | Object name | Function | Size | Flags |
|-----|-----------------|-----------------|---------------------|------------|
| 15 | Setpoint | Setpoint | 9.004 DP_Lux | CRW |

Occupancy setpoints are received via the group address linked to this object.

You can change day light level via the group address linked to this object.

*Only accessible if internal or external daylight cell is used.

| 17 | TimeDelay | TimeDelay | 7.005 DP_Time_Period_Sec | CRW |
|----|------------------|------------------|---------------------------------|------------|
|----|------------------|------------------|---------------------------------|------------|

Occupancy TimeDelays are received via the group address linked to this object.

If the value received is less than 5 s the time delay is set automatically to 5 s.

You can change the value by supervisor.

If the value received.

| 19 | Recall | Recall | 1.010 DP_Start/stop | CW |
|----|---------------|---------------|----------------------------|-----------|
|----|---------------|---------------|----------------------------|-----------|

Recalls are received via the group address linked to this object.

Start: Recalls the initial values of Setpoint and TimeDelay; the values configured before the changes operated via objects.

Stop: No reaction.

12. COMMUNICATION OBJECTS (continued)

■ 12.8 Virtual Keycard

The function is triggered by the "door contact" event which launch the so called "Virtual keycard time delay", a time offset in which the sensor understand if the room is occupied or not, based on some informations: sensor detection, door contact events, push buttons event. Once the result of the function is "occupied" it remains until there is another "Door contact event" which trigger another "Virtual keycard time delay" to understand the room status and eventually turn OFF the lights, launch an absence scenario or launch any other logic related to vacancy event.

Page only available for Master Detection Only and Master Light level & Detection modes.

12.8.1 Use Virtual Keycard

| Parameters | Settings |
|---------------------|-----------|
| Use virtual keycard | No Yes |

No: The virtual keycard function cannot be used, no accessible communication objects

When use virtualkeycard is yes: this object communication is available.

| No. | Object name | Function | Size | Flags |
|-----|-----------------|--------------|-----------------|-------|
| 31 | Virtual Keycard | Door contact | 1.001 DP_On/Off | CRWTU |

VKC_Door_contact telegrams are received via the group address linked to this object

| 33 | Virtual Keycard | Status | 1 bit | CT |
|----|-----------------|--------|-------|----|
|----|-----------------|--------|-------|----|

VKC Statuses are sent via the group address linked to this object

| 36 | Virtual Keycard | In detection | 1.003 DP_Boolean | CW |
|----|-----------------|--------------|------------------|----|
|----|-----------------|--------------|------------------|----|

VKC in detection telegrams are received via the group address linked to this object

With object 36 is possible to associate others sensors and extend the detection zone of the first sensor.

12. COMMUNICATION OBJECTS (continued)**■ 12.8 Virtual Keycard (continued)****12.8.1 Use Virtual Keycard (continued)****12.8.1.1 Sensitivity**

| Parameters | Settings |
|--------------------|---|
| Sensitivity | Low Medium High Very high |

This parameter determines the numbers of detections needed to confirm presence.

Low: 5 detections in 20 seconds

Medium: 4 detections in 20 seconds

High: 3 detections in 20 seconds

Very high: 2 detections in 20 seconds

12.8.1.2 Window time (min)

| Parameters | Settings |
|--------------------------|----------|
| Window time (min) | 3-255 |

This parameter is the "Virtual keycard time delay". It determines the delay after a door contact in which the sensor check if there is presence and change the status from absence (object status=0) to presence (object status=1).

12.8.1.3 Door event condition

| Parameters | Settings |
|-----------------------------|--|
| Door event condition | Rising edge 0 → 1 Falling edge 1 → 0 |

This parameter determines the door event condition on the VKC door contact object.

It determines if the « door contact event » is measured on the rising or falling edge

| No. | Object name | Function | Size | Flags |
|-----|-----------------|--------------|-----------------|-------|
| 31 | Virtual Keycard | Door contact | 1.001 DP_On/Off | CRWTU |

VKC_Door_contact telegrams are received via the group address linked to this object

12. COMMUNICATION OBJECTS (continued)

■ **12.8 Virtual Keycard (continued)**

12.8.1 Use Virtual Keycard (continued)

12.8.1.4 External event object type

| | |
|----------------------------|--------|
| External event object type | Switch |
| External event comparator | == |
| Compared value | Off |

| Parameters | Settings |
|---|--|
| External event object type | None Switch Scaled value Scene 2-bytes 4-bytes |
| This parameter determines the Data point type of the VKC external object. This object is used to improve the function effectiveness, it is an additional object used to confirm the presence information. It can be a command switch, detection in the room, window contact... | |
| External event comparator | == (equal) != (different) < (less than) <=(less than or equal) >(greater than) >=(greater than or equal) |
| This parameter determines the type of comparison between the value on a VKC external object and the value to be compared | |
| Compared value | On (Switch) Off (Switch) 0-100 (Scaled value) 1-64 (Scene) 0-64 (Scene) 0-65535 (2-bytes) 0-4294967295 (4 bytes) |
| This is the type of value to be compared | |

| No. | Object name | Function | Size | Flags |
|-----|-----------------|----------------|---|-------|
| 32 | Virtual Keycard | External event | DPT depend on the choice made in the settings | CW |

VKC_external event telegrams are received via the group address linked to this object. DPT depend on the choice made in the settings

12. COMMUNICATION OBJECTS (continued)

■ **12.8 Virtual Keypad (continued)**

12.8.1 Use Virtual Keypad (continued)

12.8.1.5 Occupied and Unoccupied object type

Action on presence and absence event.

| Parameters | Settings |
|---|--|
| Occupied object type | No Switch Scaled value HVAC Mode Scene 2-bytes value |
| This parameter determines the Data point type of the VKC presence action object | |
| Value | On (Switch) Off (Switch) 0-100 (Scaled value) 0-255 (HVAC Mode) 1-64 (Scene) 0-65535 (2-bytes) |
| Value to send to the VKC occupied object | |
| Unoccupied type object | No Switch Scaled value HVAC Mode Scene 2-bytes value |
| This parameter determines the Data point type of the VKC absence action object | |
| Value | On (Switch) Off (Switch) 0-100 (Scaled value) 0-255 (HVAC Mode) 1-64 (Scene) 0-65535 (2-bytes) |
| Value to send to the VKC Unoccupied object | |

• **Example with a Switch object type**

| No. | Object name | Function | Size | Flags |
|-----|----------------|--------------------------|--------|-------|
| 34 | Virtual Keypad | VKC_presence_action_1bit | Switch | CT |

VKC presence actions are sent via the group address linked to this object.
DPT depend on the choice made in the settings

| | | | | |
|----|----------------|-------------------------|--------|----|
| 35 | Virtual Keypad | VKC_absence_action_1bit | Switch | CT |
|----|----------------|-------------------------|--------|----|

VKC absence actions are sent via the group address linked to this object.
DPT depend on the choice made in the settings

12. COMMUNICATION OBJECTS (continued)

12.8 Virtual Keycard (continued)

12.8.1 Use Virtual Keycard (continued)

12.8.1.6 Send status when

Send status when

| Parameters | Settings |
|------------------|---|
| Send status when | Never Occupied only Unoccupied only Occupied & unoccupied |

This parameter determines when to send a value on the VKC status object
Never: No value sent to VKC status, but can be read on request
Occupied: Only occupied is sent to VKC status (Occupied)
Unoccupied: Only unoccupied is sent to VKC status (Not occupied)
Occupied & unoccupied: Both are sent to VKC status (Occupied and Not occupied)

12.8.2 Virtual keycard function operating diagram

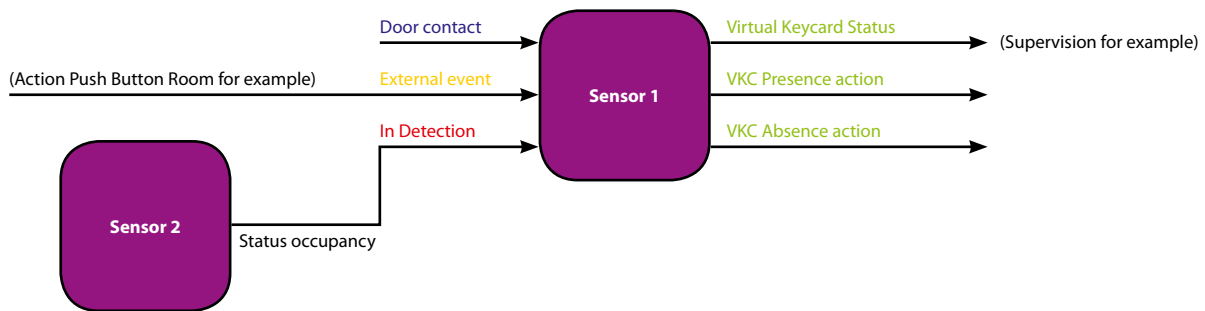

Virtual keycard behaviour:

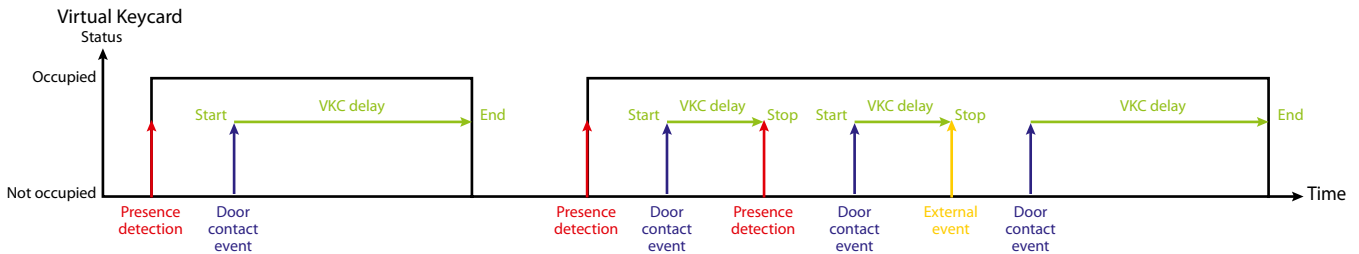

VKC function is triggered by "door contact" event after which begins the "VCK time delay" to understand if there is or not presence in the room. If during this time offset nothing is detected the result of the function is "vacancy" and the logics tied to the VKC function are not activated (first half of the above diagram). In case of detection during the time offset the result of the function is "occupancy", the "VCK time delay" is stopped and the related logics are triggered (second half of the above diagram). The VCK time delay restarts after another "door contact event". During the "VCK time delay" the "occupancy" status can be determined by the combination of more events: presence sensor "detection event" or external events (window contact, push-button pressure...).

12. COMMUNICATION OBJECTS (continued)

■ 12.9 Commissioning Tool

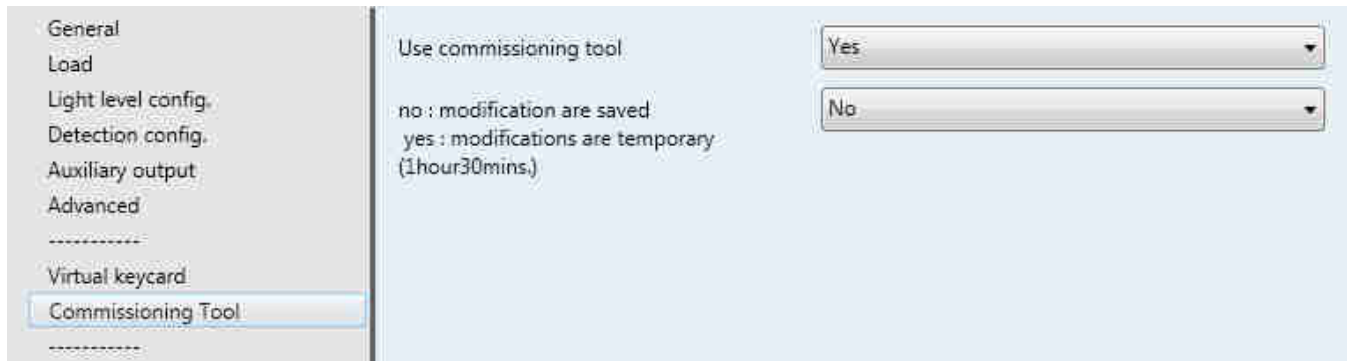

| Parameters | Settings |
|--|------------------|
| Use commissioning tool | Yes No |
| No: The sensor parameters can be only read with the commissioning tool Yes: The sensor parameters can be changed with the commissioning tool | |
| No: modification are saved | No Yes |
| No: Modifications are saved to the memory but change when a new application with ETS is downloaded Yes: Modifications are applied for 1 hour 30 minutes after the product has reloaded the default value; or if the product is disconnected from the bus, the default value is reloaded when the product is reconnected | |

13. APPLICATION'S EXAMPLES

Following are described some common applications.

Here are listed the involved products and the needed objects, to be connected, in order to realize the described functions.

■ 13.1 Mode Auto ON/OFF – Load ON/OFF

The represented associations are valid in the following configuration cases:

- light level only with regulation
- detection only without regulation
- light level and detection without regulation
- light level and detection with regulation

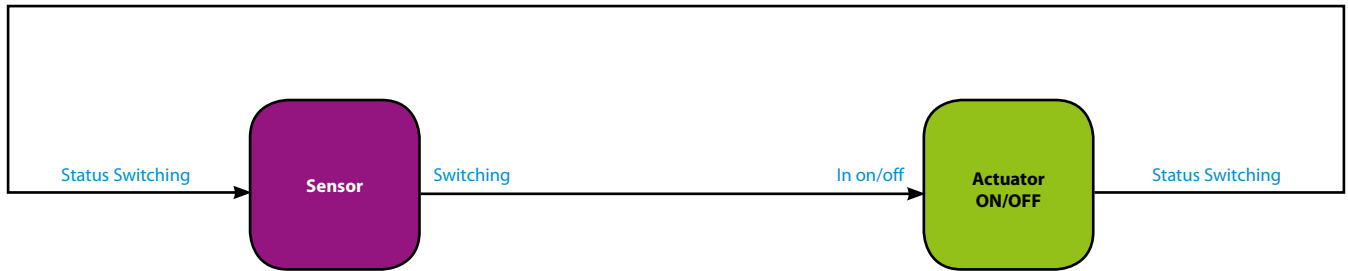

■ 13.2 Mode Auto ON/OFF – Dimming load

The represented associations are valid in the following configuration cases:

- detection only without regulation
- light level only with regulation
- light level and detection without regulation
- light level and detection with regulation

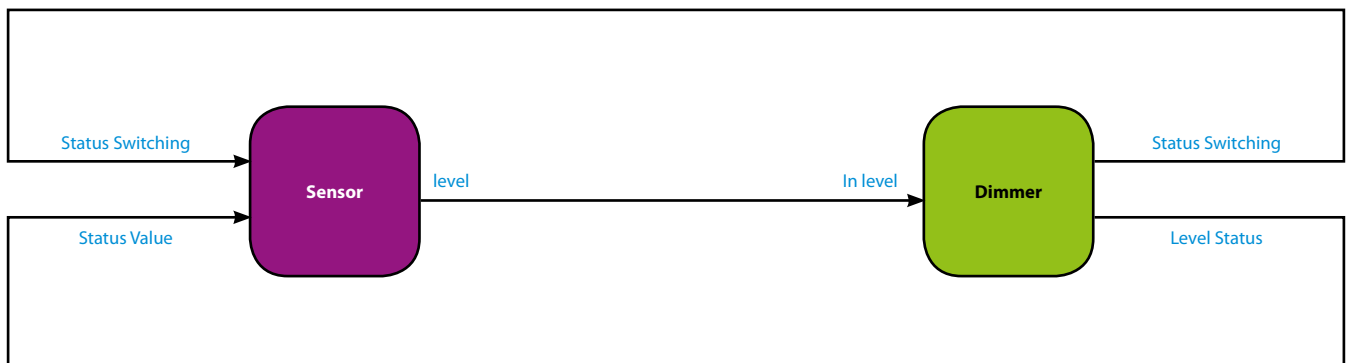

■ 13.3 Mode Manual ON/Auto OFF – Load ON/OFF

The represented associations are valid in the following configuration cases:

- detection only without regulation
- light level only with regulation
- light level and detection without regulation
- light level and detection with regulation

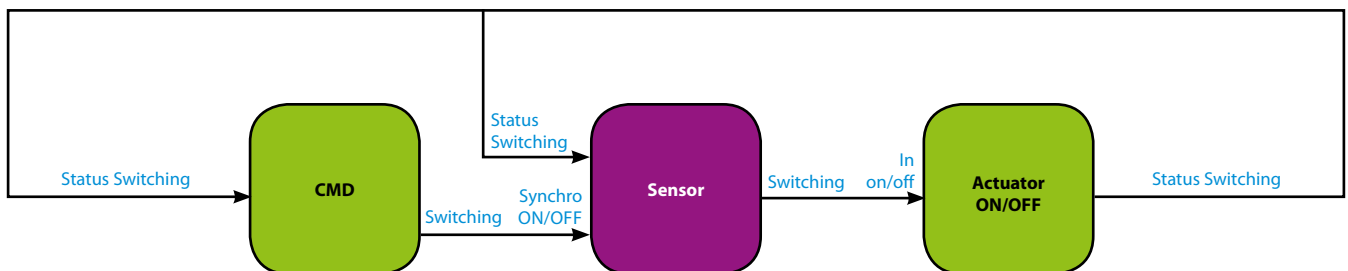

13. APPLICATION'S EXAMPLES (continued)

■ 13.4 Mode Manual ON/AutoOFF – Dimming load

The represented associations are valid in the following configuration cases:

- detection only without regulation
- light level only with regulation
- light level and detection without regulation
- light level and detection with regulation

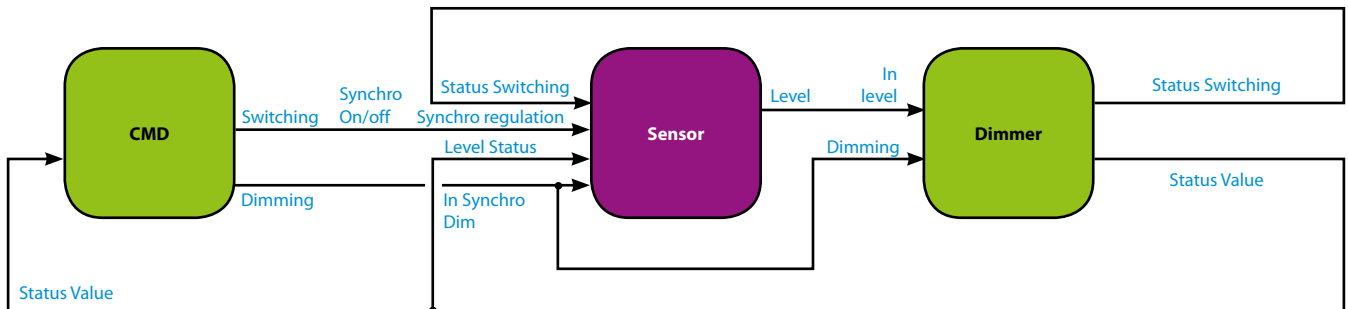

■ 13.5 Master/Slave detection

The represented associations are valid in the following configuration cases:

Ex: without regulation/load ON/OFF

