

Snap-on columns and accessories (export range)

Number(s) : 0 111 88 - 0 307 87 - 0 310 69 –
6 038 07/56/57/58 – 6 530
06/07/08/10/11/12/13/14/15/26/27/28/30/31/32/33/34/35/50/51/52/
56/66/67/68/75/76/80/81/82/83 – 980979 to 990



6 530 10/11/12/13/14/30/31/32/33/34/35



6 530 50/51/52



6 530 06/07/08/26/27/28

CONTENTS

	Pages
1. Description and Composition	1 to 2
2. Installation	2 to 3
3. Dimensions	3 to 4
4. Technical characteristics and standards	5 to 7
5. Accessories	8 to 10
6. Corian	11 to 13
7. Spare parts	15

1. DESCRIPTION AND COMPOSITION

1.1. Columns 1 or 2 compartments nr. 6 530 10/11/12/13/14/15/30/31/33/33/34/35

Range & Characteristics :

- . white = RAL 9003
- . black = RAL 9017
- . alu = anodised (no RAL)

Direct clipping	1 cpt 2 sides	colour	body	cover	2,8m to 4,05m	4,05m to 5,3m
		white	alu	PVC	6 530 10	6 530 13
Direct clipping	2 cpt	alu	alu	alu	6 530 11	6 530 14
		black	alu	PVC	6 530 12	6 530 15
		white	PVC	PVC	6 530 30	6 530 33
		alu	alu	alu	6 530 31	6 530 34
		black	alu	PVC	6 530 32	6 530 35

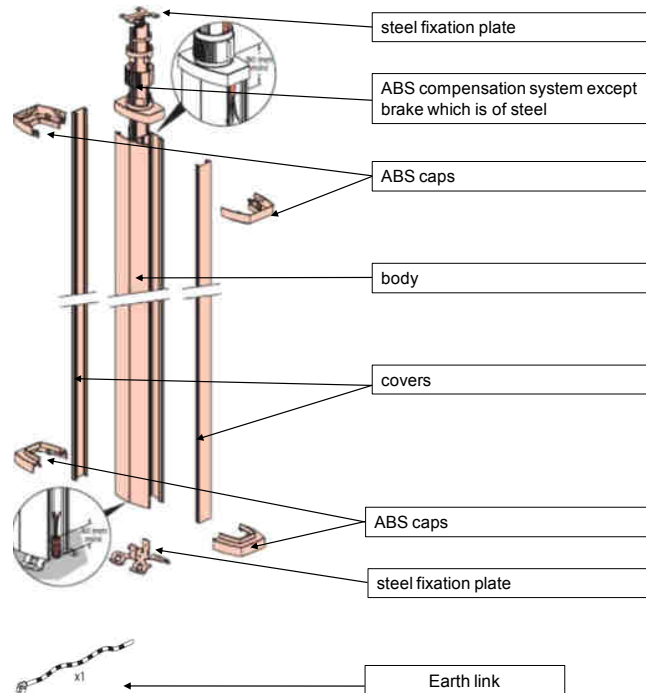

1. DESCRIPTION AND COMPOSITION (CONT.)

1.2. Movable columns 1 or 2 compartments nr 6 530 06/07/08/26/27/28

Range & Characteristics :

- . white = RAL 9003
- . black = RAL 9017
- . alu = anodised (no RAL)

Direct clipping	1 cpt 2 sides	colour	body	cover	2m
		white	alu	PVC	6 530 06
Direct clipping	2 cpt	alu	alu	alu	6 530 07
		black	alu	PVC	6 530 08
		white	alu	PVC	6 530 26
		alu	alu	alu	6 530 27
		black	alu	PVC	6 530 28

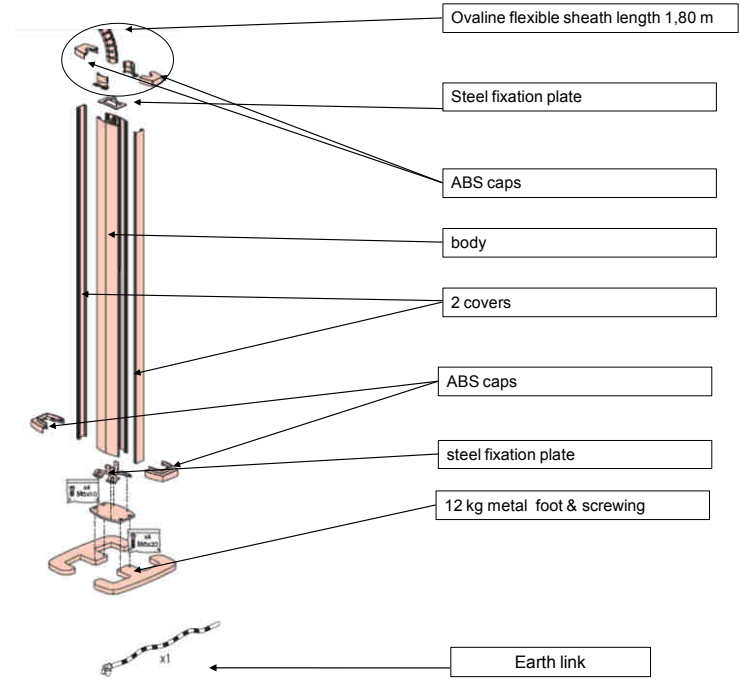

Snap-on columns and accessories (export range)

Number(s) : 0 111 88 - 0 307 87 - 0 310 69 – 6 038 07/56/57/58 - 6 530

06/07/08/10/11/12/13/14/15/26/27/28/30/31/32/33/34/35/50/51/52/56/66/67/68/75/76/80/81/82/83 - 980979 to 990

1. DESCRIPTION AND COMPOSITION (CONT.)

1.3 Columns 4 compartments with telescopic pole nr. 6 530 50/51/52

Range & Characteristics :

- . white = RAL 9003
- . black = RAL 9017
- . alu = anodised (no RAL)

			colour	body	cover	3,3m
Direct clipping		4 cpt	white	alu	PVC	6 530 50
			alu	alu	alu	6 530 51
			black	alu	PVC	6 530 52

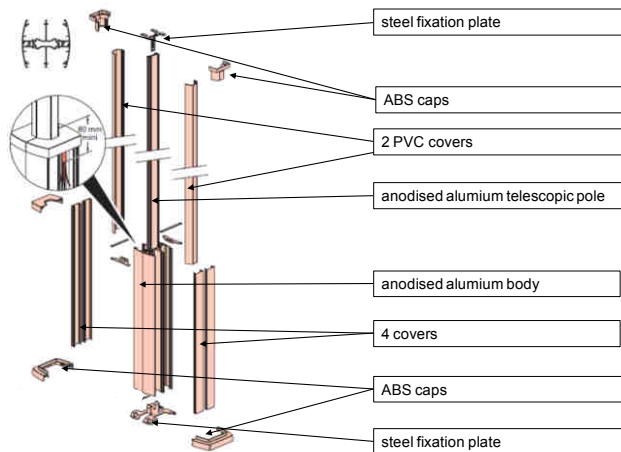

2. INSTALLATION

Installation inside only.

Be sure to be in accordance with the electrical installation and earthing procedures.

To be used with of Arteur or Mosaic wiring devices. Please add the Normaclip accessory :



Numbers	Colour
6 038 57	white
6 038 58	aluminium
6 038 56	black

- with anti-pullout and anti-slip system
- respect of protection class (IP40)
- perfect finition of junction with covers

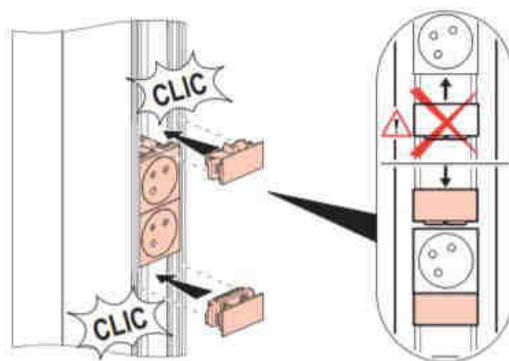

Be sure to follow the installation below : please put 2 sockets maxi (4 modules maxi) between 2 Normaclips :

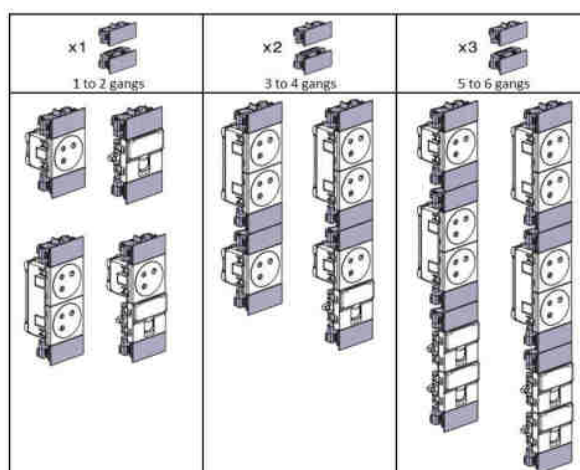

Snap-on columns and accessories (export range)

Number(s) : 0 111 88 - 0 307 87 - 0 310 69 – 6 038 07/56/57/58 - 6 530
06/07/08/10/11/12/13/14/15/26/27/28/30/31/32/33/34/35/50/51/52/
56/66/67/68/75/76/80/81/82/83 - 980979 to 990

2. INSTALLATION (CONT.)

Power supply via cable.
Be sure to respect the mini cable length or sheath from the bottom of the column

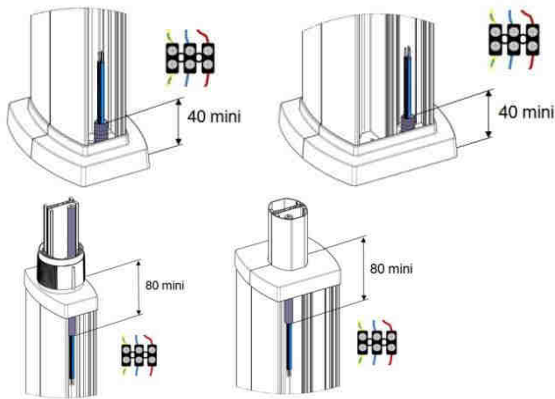

Electricity can be supplied through the floor, via ceiling or via raised floor/over floor trunking.

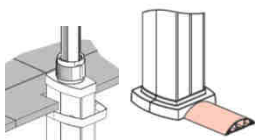

Installation compatible with over floor trunking
50x12 number 0 300 92
and
75x18 numbers 0 300 88/90/91/93
and
92x20 numbers 0 328 00

Except movable columns (nr 6 530 06/07/08/26/27/28), be sure to be in accordance with the columns fixation. In order to get a safe and lasting installation, columns have to be screwed on the floor via the plate

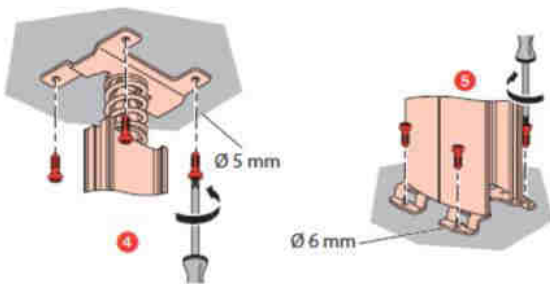

3. DIMENSIONS (CONT.)

3.1 Columns 1 or 2 compartments nr. 6 530 10/11/12/13/14/15/30/31/33/33/34/35

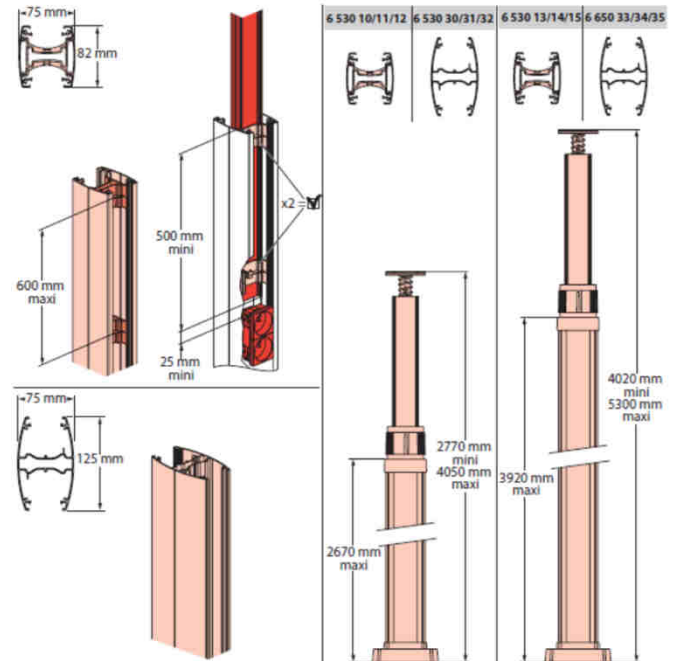

Mounting holes centers dimensions

For columns nr 6 530 10/11/12/13/14/15	For columns nr 6 530 30/31/32/33/34/35

Snap-on columns and accessories (export range)

Number(s) : 0 111 88 - 0 307 87 - 0 310 69 – 6 038 07/56/57/58 - 6 530
06/07/08/10/11/12/13/14/15/26/27/28/30/31/32/33/34/35/50/51/52/
56/66/67/68/75/76/80/81/82/83 - 980979 to 990

3. DIMENSIONS (CONT.)

3.2. Movable columns 1 or 2 compartments nr 6 530 06/07/08/26/27/28

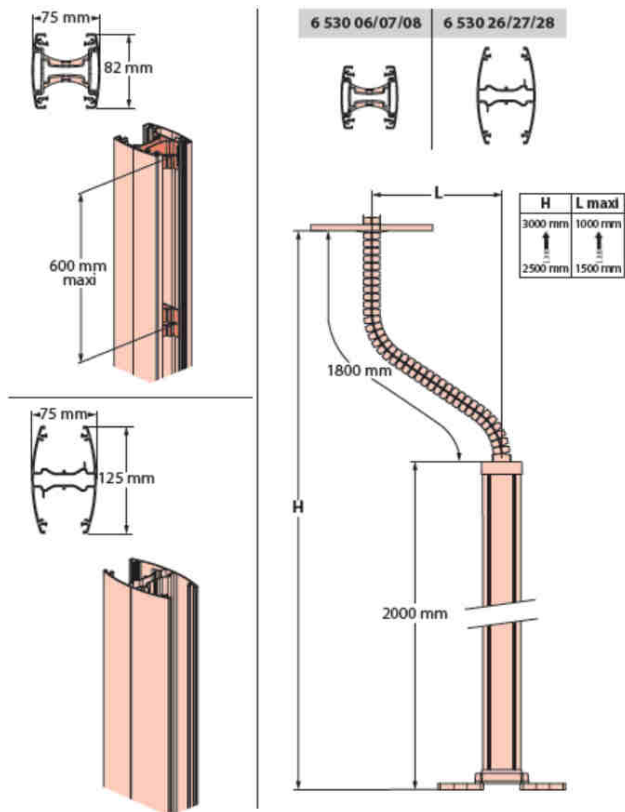

Foot space on the floor

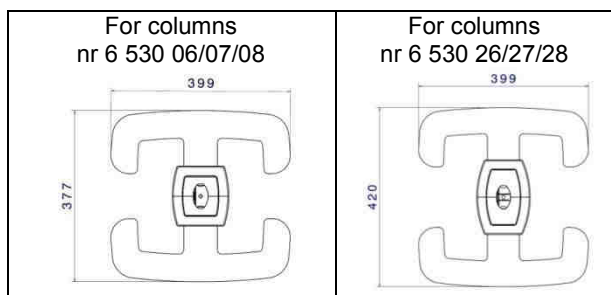

3. DIMENSIONS (CONT.)

3.3. Columns 4 compartments nr 6 530 50/51/52

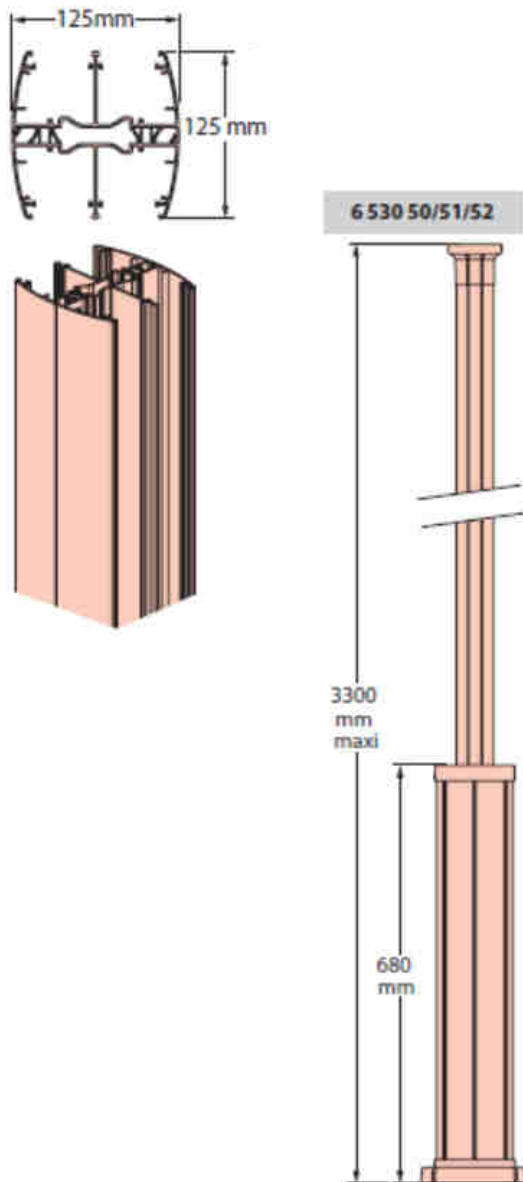

Mounting holes centers dimensions

For columns
Nr 6 530 50/51/52

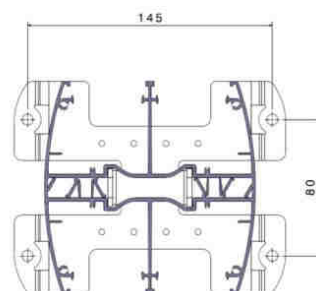

4. TECHNICAL CHARACTERISTICS AND STANDARDS

Classifications: EN 50085-1 et EN 50085-2-4

Cable trunking systems and cable ducting systems for electrical installation

6.2 Resistance to impact for installation and application	2J
6.3 Minimum storage and transport temperature	-25°C
6.3 Minimum installation and application temperature	-5°C
6.3 Maximum application temperature	60°C
6.4 Resistance to flame propagation	Non-flame propagating
6.5 Electrical continuity characteristic	Yes
6.6 Electrical insulating characteristic	without electrical insulating characteristic
6.7 Degrees of protection provided by enclosure	IP 3XD Movable cable trunking: IP2X
6.9 The system access cover retention	With a tool
6.101 Floor treatment	dry-treatment of floor
6.102 resistance to vertical load	Non applicable
Electrical impedance	5mΩ/m
Transversal section	<i>look at cabling capacity here under</i>
Protection against mechanical impact	IK07

Reference Cable trunking systems among EN50085-1 et EN50085-2-5

Designation	Reference
1 compartment	6 530 06/08/10/12/13/15
2 compartments	6 530 26/28/30/32/33/35
3 compartments	6 530 50/52



Autres caractéristiques

RoHS material	European directive 2002/95/CE : 27/01/2003
Product Environmental Profile : available	PEP sheet or document
Coating	International standard DIN EN ISO846

4. TECHNICAL CHARACTERISTICS AND STANDARDS (CONT.)

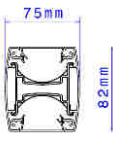
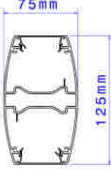
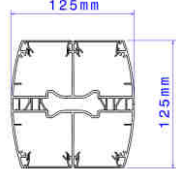
Cabling capacity

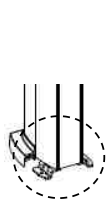
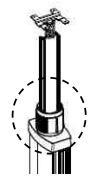
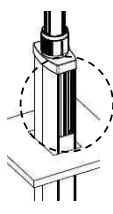
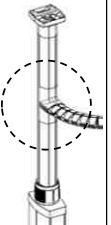
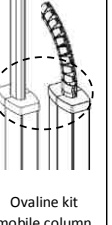
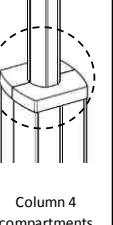
		COLUMN PROFILE					
		1 COMPARTMENT		2 COMPARTMENTS		4 COMPARTMENTS	
							
		A	B	C	D	E	F
	Section (mm ²)	1440	20	3110	1470	2760	1110
Ø of cable	Ø7 mm	16	-	43	18	40	14
	Ø9 mm	10	-	26	11	23	8
	Ø11 mm	6	-	14	6	14	4

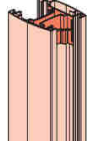
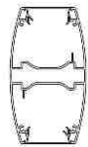
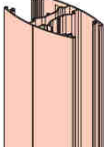
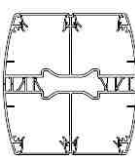
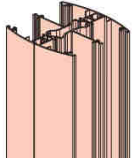
		According to the arrival of cables							
		1	2	3	4	5	6		
									
Ø of cable	Ø7 mm	14	16	32	12	12			
	Ø9 mm	8	12	20	6	6			
	Ø11 mm	4	6	12	4	4			
Ø of cable	Ø7 mm	42	26	86	12	12			
	Ø9 mm	24	14	52	6	6			
	Ø11 mm	16	8	28	4	4			
Ø of cable	Ø7 mm	52			12		28		
	Ø9 mm	32			6		16		
	Ø11 mm	24			4		8		

4. TECHNICAL CHARACTERISTICS AND STANDARDS (CONT.)

Only for movable columns

Allowed weights for the following accessories :

Accessories	Maxi weights allowed
Shelf nr 6 530 83	15 kg
Support for fixing TV screen 10-26 inch nr 6 530 81	15 kg
Support for fixing TV screen 26-42 inch nr 6 530 82	30 kg

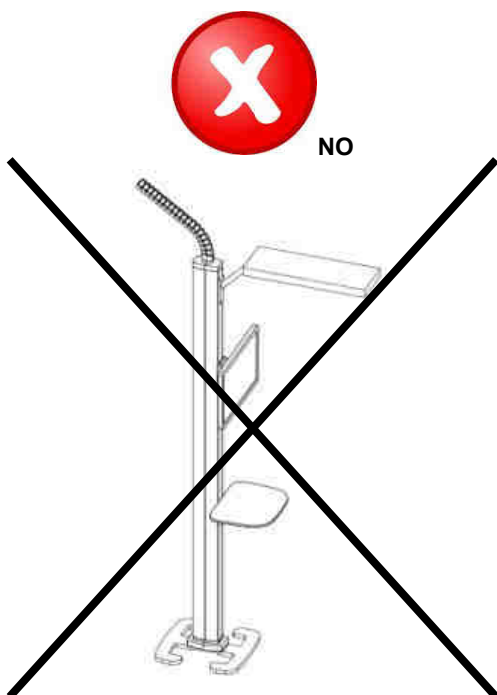

Snap-on columns and accessories (export range)

Number(s) : 0 111 88 - 0 307 87 - 0 310 69 – 6 038 07/56/57/58 - 6 530

06/07/08/10/11/12/13/14/15/26/27/28/30/31/32/33/34/35/50/51/52/56/66/67/68/75/76/80/81/82/83 - 980979 to 990

5. ACCESSORIES

5.1 Junction for false ceiling nr 6 530 76 for movable columns

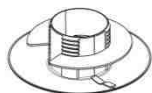

This junction allows one perfect finishing of the connection between the column and the false ceiling. In order to get a perfect integration, it is necessary to make a hole in the false ceiling.

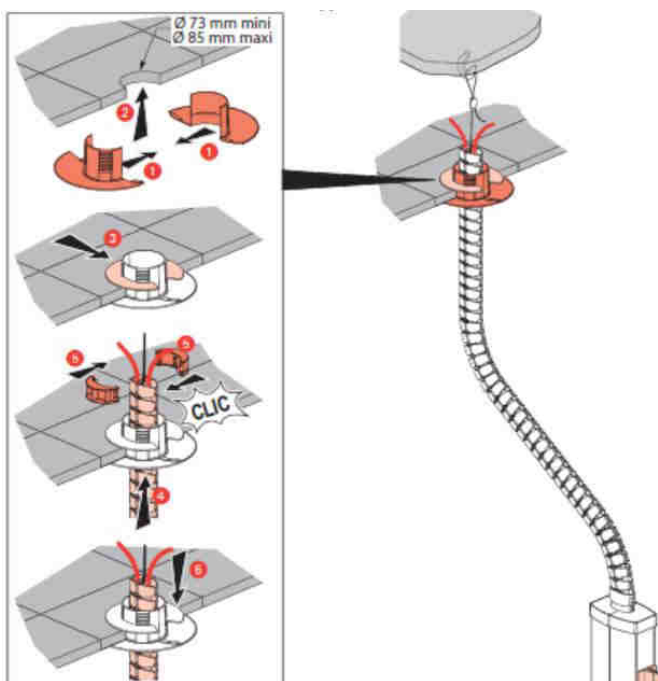

Material : ABS and PETG

5. ACCESSORIES (CONT .)

5.2 Finishing kit for telescopic pole for 1 or 2 compartments columns nr 6 530 66/67/68

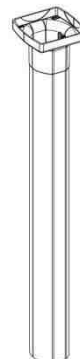

This kit allows an aesthetic finishing of telescopic pole, of the cable leading down and its height adjustment at the top of the column.

Consists of 2 PVC covers and a base

- 3 Colours :
- 6 530 66 white finish
 - 6 530 67 grey finish
 - 6 530 68 black finish

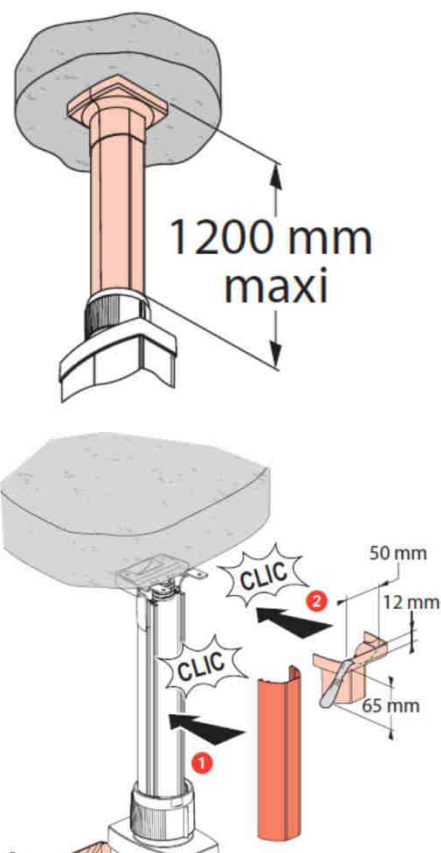

Material :

- covers : PVC
- base : ABS

Snap-on columns and accessories (export range)

Number(s) : 0 111 88 - 0 307 87 - 0 310 69 – 6 038 07/56/57/58 - 6 530

06/07/08/10/11/12/13/14/15/26/27/28/30/31/32/33/34/35/50/51/52/56/66/67/68/75/76/80/81/82/83 - 980979 to 990

5. ACCESSORIES (CONT .)

5.3 Flexible Ovaline kit nr 6 530 56 for telescopic pole finishing kit



This 1 m length accessory allows one aesthetic horizontal connection between the column and cable trays.
To fix on the column.

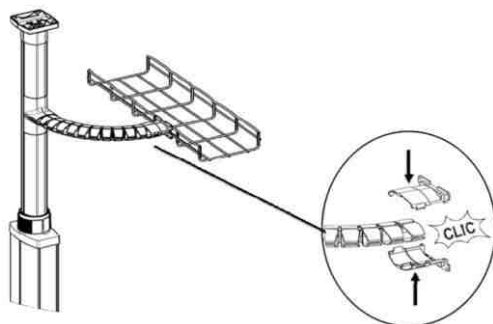
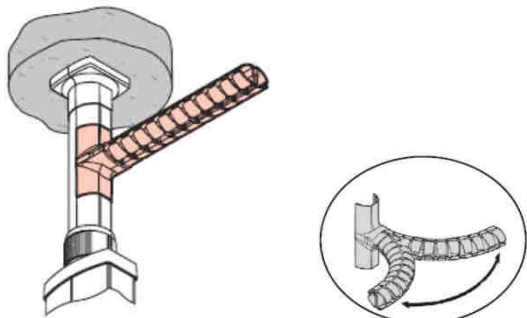

Material :

- Flexible Ovaline : Polypropylène
- Connection accessories : ABS

5.4 Separation partition nr 6 038 07

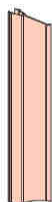

For 2 and 4 compartments snap-on mini-columns. It allows the separation in a same compartment, between power and data cables.

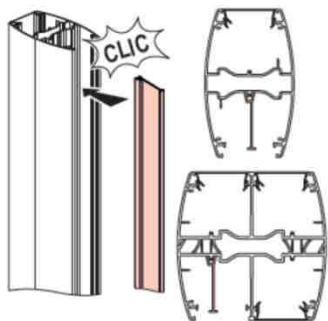

5. ACCESSORIES (CONT .)

5.5 Supports for rail equipment



Numbers	Colour
0 310 69	white
0 307 87	aluminium
6 530 75	black

For mounting  equipment (such as MCBs) on mini-columns. To be used with two 0.5 module spacing units cat. Nr 4 063 07

Capacity : 1 module

Equipped with protective cover to prevent unwanted triggering

Material : ABS (back part) + PC (front part)

5.6 90° Adaptor nr 6 530 079

Adaptor for mounting Arteor or Mosaic wiring accessories horizontally via 90° rotation
2 modules

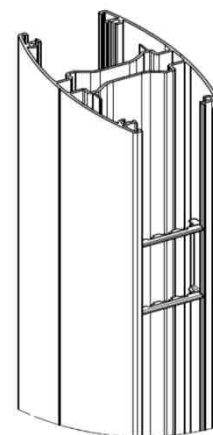
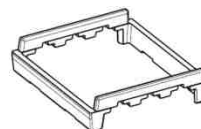

Snap-on columns and accessories (export range)

Number(s) : 0 111 88 - 0 307 87 - 0 310 69 – 6 038 07/56/57/58 - 6 530
06/07/08/10/11/12/13/14/15/26/27/28/30/31/32/33/34/35/50/51/52/56/66/67/68/75/76/80/81/82/83 - 980979 to 990

5. ACCESSORIES (CONT .)

5.7 Support for fixing TV

5.7.1 Support nr 6 530 81 for fixing TV 10-26 inch /25-66 cm (VESA 75x75 – 100x100)



Allowed maximum weight : 15 kgs
Material : Metal

5.7.2 Support nr 6 530 82 for fixing TV 26-42 inch/66-107 cm (VESA 200x100 – 200x200)



Lateral orientation : 45° right – 45° left
Top and down : 15°

Allowed maximum weight : 30 kgs
Material : Metal

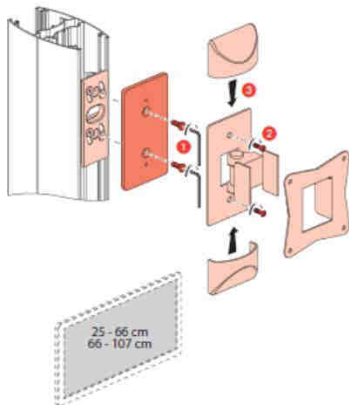

5.8 Panel indicator nr 6 530 80



This simple and aesthetic accessory allows you to slide in any information.



6 530 80

5. ACCESSORIES (CONT .)

Attention !! This accessory is not made for replacing one urgency emergency lighting luminaire and should not be considered as one.

Panel indicator dimension : 150 x150 mm
Material : Alu + glass

5.9 White shelf nr 6 530 83

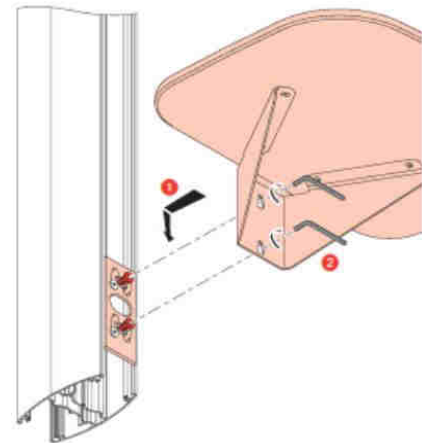

Dimensions : 380 x 300 x 12 mm

Allowed maximum weight : 15 kg

Material :
- shelf = Corian© (cf §6.1)
- mounting bracket = steel

5.10 Earth link nr 0 111 88



Allows earth link for the mini-columns
(20 pcs/nr)

6. CORIAN

6.1. Characteristics



Short Form Classification Report No. 16893B

PRODUCT

DuPont Corian® Solid Surface

SPONSOR

DuPont De Nemours (Belgium) BVBA

PRODUCT DETAILS

- Thickness: Between 6 mm and 12.3 mm (± 0.7 mm)
- Density: Between 1645 kg/m³ and 1770 kg/m³
- Colour/pattern: Any colour variation allowed
- Use of fire retardants: No
- Product composition: No variation allowed
- Product construction: No variation allowed

FIELD OF APPLICATION

- Construction applications used over any substrate with a density equal to or greater than 800 kg/m³, having a minimum thickness of 12.5 mm and a fire performance of A2 or better.
- Product installed utilizing Corian® silicone sealant only

CLASSIFICATION

C-s1,d0

STANDARDS

Test standards: EN ISO 11925-2:2002 & EN 13823:2002
Classification standard: EN 13501-1-2007

SIGNED BY

Nick De Pauw (Signature)
Project assistant
Ghent
2016.06.14 13:22:00 +02'00'

APPROVED BY

Bart Sette (Signature)
General Manager
2016.06.15 10:27:43
+02'00'

For end on behalf of WFRGENT nv

This short form classification report has been drafted according to EGOLF agreement EGA.08rev2:2013 "Application note: clause 5.10 [5.10/1] – Types of test reports used in fire testing". Whilst the test data and classification provided within this short form report was obtained in a test conducted fully in accordance with the standards EN ISO 11925-2:2002, EN 13823:2002 and EN 13501-1:2007, the presentation of the results in this short form report may not satisfy the requirements of those standards and EN ISO/IEC 17025:2005/AC:2006. The presentation of the results in this manner is made by agreement with the sponsor and use of the information herein for product assessment, approval or certification purposes will be restricted.

The full classification report No.165122 (Issue 4) is available at DuPont De Nemours (Belgium) BVBA.

This document is the original version of this report and is written in English. This document may be used only literally and completely for publications. For publications of certain texts, in which this document is mentioned, our permission must be obtained in advance. The authenticity of the electronic signatures is assured by Belgium Root CA.



WFRGENT NV - Olttergemiesteenweg-Zuid 711 - B-9000 Gent - België
t: +32 9 243 77 50 - f: +32 9 243 77 51 - e: info@wfrgent.com
BTW/VAT/TVA: BE0870.418.414 - Ondernemingsnummer: RPR GENT 0870.418.414

WFRGENT NV is een spin-offbedrijf van de Universiteit Gent, vroege naam Laboratorium voor Aansluiting der Brandstoffen en Warmteoverdracht - Afdeling Brandveiligheid
WFRGENT NV is a spin-off company from the University of Ghent, previously the Laboratory for Heat Transfer and Fuel Technology - Fire Safety Division
WFRGENT SA est une compagnie spin-off de l'Université de Gand, autrefois le Laboratoire pour l'Emploi des Combustibles et la Transmission de la Chaleur - Division Sécurité Incendie

6. CORIAN (CONT.)

6.2. Cleaning



Caring for DuPont™ Corian®

Pleje af DuPont™ Corian®

Pflegehinweise für DuPont™ Corian®

Uso y cuidado de DuPont™ Corian®

Entretien des produits DuPont™ Corian®

Cura dei materiali DuPont™ Corian®

Onderhoud van DuPont™ Corian®

Vedlikehold av DuPont™ Corian®

Wskazówki dotyczące użytkowania i konserwacji materiału DuPont™ Corian®

Skötsel av DuPont™ Corian®

DuPont™ Corian® 'in Bakımı

Φροντίδα του DuPont™ Corian®

Уход за поверхностями DuPont™ Corian®



6. CORIAN (CONT.)

6.2. Cleaning

ENGLISH

Caring for DuPont™ Corian®

DuPont™ Corian® was created for a lifetime of easy care. Just follow the simple guidelines listed here to help keep your Corian® surfaces looking beautiful.

Routine care of your Corian® surface

For everyday cleaning, use soapy water or widely available surface cleaners.

Remove excess detergent with a soft cloth, rinse surface with warm water and dry with a soft cloth.

If necessary use a microfibre cloth and rub over the surface with an ammonia based cleaner, then rinse with water.

This procedure will remove most dirt and residue from your Corian® surfaces.

Always clean using a circular motion, from the front to the back, then side to side, overlapping the circles until the entire area has been cleaned. Do not use abrasive or mild abrasive cleaners on high gloss or dark surfaces.

Be aware that limescale can build up if water is left to dry on the surface.

To prevent this, it is important to wipe the surface completely dry with a microfibre cloth after spills and cleaning.

Some colours of Corian® may require more frequent cleaning to maintain a uniform finish.

Special care for stubborn stains

Residues from stubborn stains may require heavier cleaning.

Follow the recommendations below to clean these specific stains from your Corian® surface and shapes effectively.

Vinegar, coffee, tea, lemon juice, vegetable juice, dyes, ketchup, lily pollen, saffron, light scratches, cigarette burns, shoe polish, ink, marker pen, iodine, mildew, mercurochrome, blood, red wine, perfume:

Use a damp microfibre cloth and a mild abrasive cleaning product (except on high gloss or dark surfaces).

Grease, fat and oil residues: Use a microfibre cloth and rub over the stain with some diluted bleach.

Rinse several times with warm water and dry with a soft cloth.

Bleach can discolour DuPont™ Corian® if not removed completely by rinsing with water afterwards.

Hard water scale, soap, minerals: Use a microfibre cloth and rub over the stain with a standard household limescale remover or vinegar and leave for 2-4 minutes.

Using a second clean microfibre cloth, rinse the area thoroughly with water.

Nail varnish spills: Use a microfibre cloth and rub over the stain with a non-acetone based nail varnish remover.

Rinse several times with warm water and dry with a soft cloth.

If the stain is still visible, repeat the operation, this time using very fine-grain sanding paper; If the stain persists, contact our Warranty Centre.

How to prevent permanent damage

Be sure to follow these guidelines to help prevent permanent damage to your Corian® installation.

Avoid getting strong chemicals – eg paint removers, oven cleaners, acid drain cleaners, acetone based nail varnish removers etc – on your surface. If a spill does occur, promptly flush the surface with water to fully rinse off the chemical.

Do not clean using aggressive chemical agents such as acetone, oven cleaners, thinners, strong acids (muriatic acid etc) or strong bases (caustic soda etc), or industrial detergents or paint solvents.

If a spill does occur, promptly flush the surface with water to fully rinse off the chemical.

Do not use metal scrapers, iron brushes or other domestic metal tools to remove stains, paints, plaster or other substances.

In the case of severe damage, please contact the DuPont™ Corian® Warranty Centre, which will put you in touch with a local DuPont™ Corian® Quality Network Industrial Partner or Service Centre for professional re-sanding or repairing of your DuPont™ Corian® installation. DuPont™ Corian® Quality Network Service Centres are certified by DuPont to carry out expert repair and finishing work. They can also handle installation work and offer maintenance contracts to commercial customers to maintain DuPont™ Corian® installations in prime condition.

Kitchen applications

SPECIAL CARE FOR SINKS

Remove all the fat and oil residues resulting from food preparation from the sink, using a detergent or surface cleaner. If necessary, use a mild abrasive cleaning pad or sponge.

Fill the sink with diluted household bleach (25% bleach and 75% water) and leave for ½ hour. Afterwards, rinse thoroughly – you should have a beautifully clean sink, with very little effort.

6. CORIAN (CONT.)

6.2. Cleaning

ENGLISH 

PREVENTING HEAT AND OTHER DAMAGE

It is important to minimise direct heat exposure to protect your Corian® surface. Always use a heat protection pad, trivet (with rubber feet) or protective sink mat for hot cookware, or leave cookware to cool on the hob first. Never put hot pans, particularly cast iron pans, directly onto a DuPont™ Corian® top or in a Corian® sink. Always use the correct size pan on the hob and place it centrally on the ring.

An overhanging pan can scorch the surrounding surface.

As with most sinks, pouring boiling liquids directly into a DuPont™ Corian® sink without running cold water at the same time may damage the material. If you have an instant boiling water tap, a container should always be used to collect the water as boiling water from this type of tap may cause surface damage in and around the sink. Do not cut directly on Corian® surfaces. Use a chopping board.

Bathroom applications

DAILY MAINTENANCE OF WASH BASINS, SHOWER TRAYS AND BATHTUBS

Simply clean the surface with soapy water or any common detergent in order to remove most of the stains and dirt that may be deposited. Gel or creamy detergents are particularly recommended, together with a mild abrasive cleaning pad or sponge, ensuring that you rinse the treated area properly.

By doing this, the original matt finish will be maintained. Some substances such as ink, cosmetics and dyes may release colour onto the surface after extended contact with the surface.

All of these can easily be removed by following the special instructions for stubborn stains.

ATTENTION

Shower trays and bathtubs cannot be used autonomously by people with reduced motor skills, or with sensory and/or cognitive impairments (including children).

For your personal safety, use them at a maximum water temperature of 40°C.

Avoid using them in the vicinity of while using electrical appliances.

Pay special attention when using shower trays and bathtubs alone or after taking medicines.

Guaranteed Quality

With proper care, your Corian® surface will stay looking like new. Your DuPont™ Corian® surface carries a Limited Installed Warranty when fabrication and installation are carried out by a Corian® Industrial Partner and member of the Corian® Quality Network. If you decide to sell your home, your warranty is transferable to the new owners. For complete details, go to our website (www.corian.com) to review the warranty guidelines applicable for your product.

This information is based on technical data that E. I. du Pont de Nemours and Company and its affiliates ("DuPont") believe to be reliable, and is intended for use by persons having technical skill and at their own discretion and risk. DuPont cannot and does not warrant that this information is absolutely correct or accurate, although every effort is made to ensure that it is kept as current and accurate as possible. Because conditions of use are outside DuPont's control, DuPont makes no representations or warranties, express or implied, with respect to the information, or any part thereof, including any warranties of title, non-infringement of copyright or patent rights of others, merchantability, or fitness or suitability for any purpose and assumes no liability or responsibility for the accuracy, completeness, or usefulness of any information. This information should not be relied upon to create specifications, designs, or installation guidelines. The persons responsible for the use and handling of the product are responsible for ensuring the design, fabrication, or installation methods and process present no health or safety hazards. Do not attempt to perform specification, design, fabrication, or installation work without proper training or without the proper personal protection equipment. Nothing herein is to be taken as a license to operate under or a recommendation to infringe any patents. DuPont shall have no liability for the use of or results obtained from such information, whether or not based on DuPont's negligence. DuPont shall not be liable for (i) any damages, including claims relating to the specification, design, fabrication, installation, or combination of this product with any other product(s), and (ii) special, direct, indirect or consequential damages. DuPont reserves the right to make changes to this information and to this disclaimer. DuPont encourages you to review this information and this disclaimer periodically for any updates or changes. Your continued access or use of this information shall be deemed your acceptance of this disclaimer and any changes and the reasonableness of these standards for notice of changes.



Snap-on columns and accessories (export range)

Number(s) : 0 111 88 - 0 307 87 - 0 310 69 – 6 038 07/56/57/58 - 6 530
06/07/08/10/11/12/13/14/15/26/27/28/30/31/32/33/34/35/50/51/52/56/66/67/68/75/76/80/81/82/83 - 980979 to 990

7. SPARE PARTS

			COLUMNS				SPARE PARTS		
			2m	3,3m	2,8m to 4,05m	4,05m to 5,3m			
			mobile	standard	standard	standard	Upper & lower caps (2 parts)		
Direct clipping		1 cpt 2 sides	6 530 06		6 530 10	6 530 13	980982		
			6 530 07		6 530 11	6 530 14	980983		
			6 530 08		6 530 12	6 530 15	980984		
		2 cpt	6 530 26		6 530 30	6 530 33	980985		
			6 530 27		6 530 31	6 530 34	980986		
			6 530 28		6 530 32	6 530 35	980987		
		4 cpt		6 530 50			980988		
				6 530 51			980989		
				6 530 52			980990		

			COLUMNS				SPARE PARTS		
			2m	3,3m	2,8m to 4,05m	4,05m to 5,3m			
			mobile	standard	standard	standard	Telescopic pole cap (2 parts)		
Direct clipping		4 cpt		6 530 50			980979		
				6 530 51			980980		
				6 530 52			980981		