



REF. 3161



**FEATURES**

- IP: 23
- Installation: Recessed with frame
- High: 121 mm
- Light Direction: Fixed
- Minimum distance to lightened objects: 0.5 m
- Lamps : LED/PAR16\*/QR-CBC51\*
- Protection class: Class II
- Cut out: Ø75 mm
- \* not included

**LED**

- Efficiency 3000K: 73 lm/W
- Efficiency 4200K: 112 lm/W
- Energy efficiency : A+
- Driver: Included
- Life time: 50.000h
- LED working constant current: 700mA
- Color rendering current: CRI ≥80
- LED Guarantee: 5 years

**MEASURES**

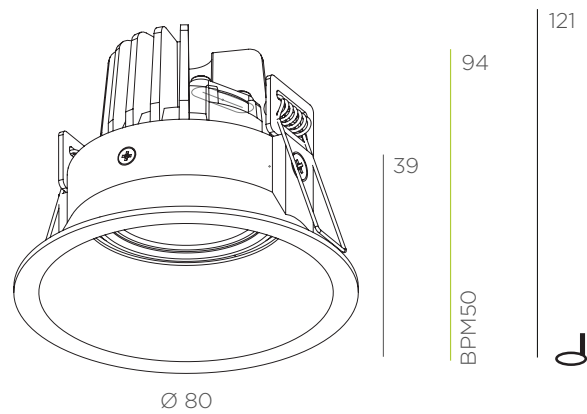

**FINISH**

















<b>BLACK</b> RAL 9011	<b>WHITE</b> RAL 9016	<b>GREY</b> RAL 9006
--------------------------	--------------------------	-------------------------

**REFLECTOR**

- 40°
- 60°

**DIMMABLE OPTIONS**

- 1.10V
- PUSH
- DALI
- PHASE CUT

		MAX 50W			3161.09GU		3161.15GU		3161.33GU
		MAX 50W			3161.09		3161.15		3161.33
		MAX 7W			3161.09LED		3161.15LED		3161.33LED