

# Datový list | Objednací číslo: 859-793

Modul s optočlenem; Vstupní jmenovité napětí DC 5 V; Rozsah výstupního napětí DC 20–60 V; Mezní trvalý proud 0,1 A; 2vodičové připojení; Konstrukční šířka 6 mm; Šedá

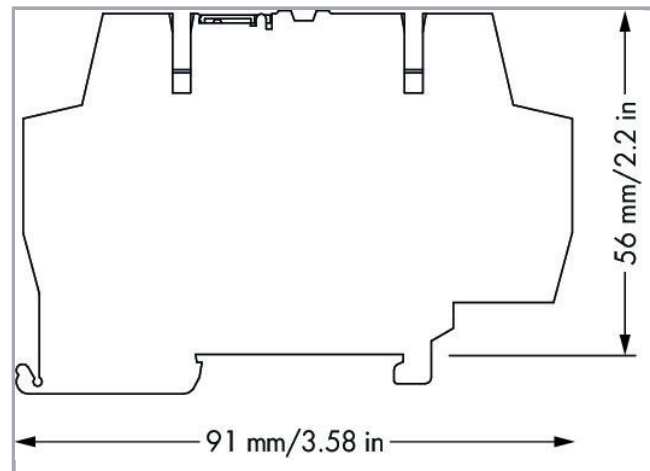

[www.wago.com/859-793](http://www.wago.com/859-793)

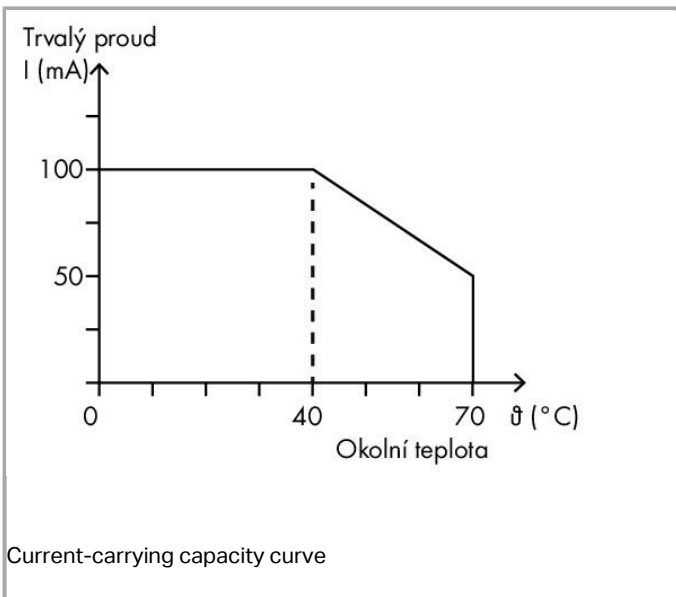
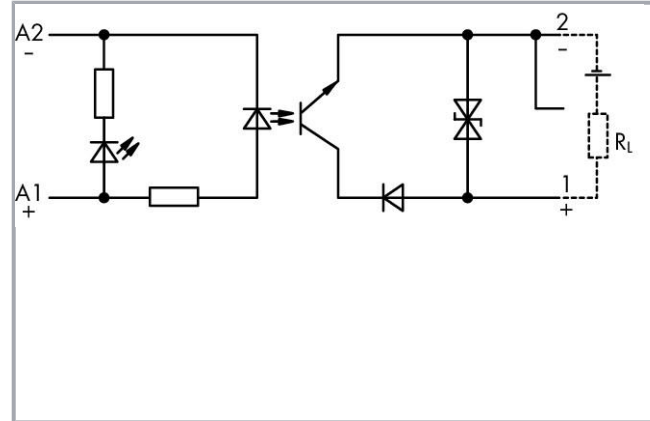
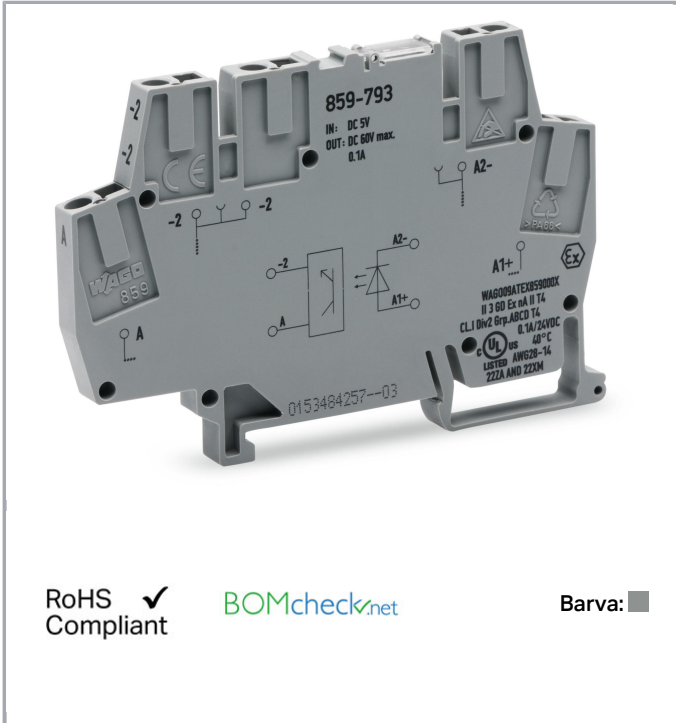

## Popis položky

Upozornění:



Optocouplers and solid state relays are designed for use in signal processing networks, which are not supplied by the low-voltage power supply networks.

## Data

### Technické údaje

#### Řídicí obvod:

Nominal input voltage $U_N$	DC 5 V
Input voltage range (low level)	DC 0 ... 0,8 V
Input voltage range (high level)	DC 2 ... 6,25 V
Jmenovitý vstupní proud $I_N$	7,5 mA

#### Zátěžový obvod:

Druh obvodu	2vodičové připojení
Limiting continuous current	0,1 A
Output voltage range	DC 3 ... 60 V
Max. voltage drop at output	$\leq$ DC 2,5 V
Leakage current at nominal voltage	$\leq$ 25 $\mu$ A
Doba zapnutí	$\leq$ 20 $\mu$ s
Drop-out time	$\leq$ 120 $\mu$ s
Switching frequency	$\leq$ 1,5 kHz

#### Signaling

Indikace stavu	LED red
----------------	---------

#### Bezpečnost a ochrana:

Dielectric strength, control/load circuit (AC, 1 min)	2,5 kVrms
---	-----------

#### Údaje o připojení

Připojovací technika	CAGE CLAMP®
Plný vodič	0,08 ... 2,5 mm <sup>2</sup> / 28 ... 14 AWG
Jemně laněný vodič	0,08 ... 2,5 mm <sup>2</sup> / 28 ... 14 AWG
Délka odizolování	5 ... 6 mm / 0.2 ... 0.24 palec

#### Geometrické údaje

Šířka	6 mm / 0.236 inch
Výška od horní hrany lišty DIN 35	56 mm / 2.205 inch
Hloubka	91 mm / 3.583 inch

## Mechanické parametry

Způsob montáže	Lišta DIN 35
----------------	--------------

## Údaje o materiálu

barva	Šedá
Požární zatížení	0.483 MJ
Hmotnost	17.929 g

## Okolní podmínky

Přípustná okolní teplota při provozu při $U_N$	-40 ... 70 °C
Okolní teplota (skladování)	-40 ... 70 °C
Processing temperature	-25 ... +50 °C

## Standardy a technické údaje

Normy/ustanovení	EN 60664-1; EN 61000-6-2; EN 61000-6-3; EN 50121-3-2; EN 61373; UL 508
------------------	--

## Obchodní údaje

Product Group	6 (Interface Electronics)
Druh balení	BOX
Country of origin	DE
GTIN	4055143606271
Customs Tariff No.	85365005000















## Atesty/certifikáty

### Atesty UL

Logo	Schválení	Doplňkový text schválení	Název certifikátu
	UL UL International Netherlands B.V. (ORDINARY LOCATIONS)	UL 508	E175199 Sec.4

## Kompatibilní produkty

## Marking accessories

	<b>Obj. č.: 2009-145</b> Mini-WSB Inline; Pro Smart Printer; Na cívce; Flexibilní, 5–5,2 mm; Bez potisku; Možnost naklapnutí; Bílá	<a href="http://www.wago.com/2009-145">www.wago.com/2009-145</a>
	<b>Obj. č.: 2009-145/000-002</b> Mini-WSB Inline; Pro Smart Printer; Na cívce; Flexibilní, 5–5,2 mm; Bez potisku; Možnost naklapnutí; Žlutá /000-002	<a href="http://www.wago.com/2009-145">www.wago.com/2009-145</a>
	<b>Obj. č.: 2009-145/000-005</b> Mini-WSB Inline; Pro Smart Printer; Na cívce; Flexibilní, 5–5,2 mm; Bez potisku; Možnost naklapnutí; Červená	<a href="http://www.wago.com/2009-145">www.wago.com/2009-145</a> /000-005
	<b>Obj. č.: 2009-145/000-006</b> Mini-WSB Inline; Pro Smart Printer; Na cívce; Flexibilní, 5–5,2 mm; Bez potisku; Možnost naklapnutí; Modrá	<a href="http://www.wago.com/2009-145">www.wago.com/2009-145</a> /000-006
	<b>Obj. č.: 2009-145/000-007</b> Mini-WSB Inline; Pro Smart Printer; Na cívce; Flexibilní, 5–5,2 mm; Bez potisku; Možnost naklapnutí; Šedá /000-007	<a href="http://www.wago.com/2009-145">www.wago.com/2009-145</a>
	<b>Obj. č.: 2009-145/000-012</b> Mini-WSB Inline; Pro Smart Printer; Na cívce; Flexibilní, 5–5,2 mm; Bez potisku; Možnost naklapnutí; Oranžová	<a href="http://www.wago.com/2009-145">www.wago.com/2009-145</a> /000-012
	<b>Obj. č.: 2009-145/000-023</b> Mini-WSB Inline; Pro Smart Printer; Na cívce; Flexibilní, 5–5,2 mm; Bez potisku; Možnost naklapnutí; Zelená	<a href="http://www.wago.com/2009-145">www.wago.com/2009-145</a> /000-023
	<b>Obj. č.: 2009-145/000-024</b> Mini-WSB Inline; Pro Smart Printer; Na cívce; Flexibilní, 5–5,2 mm; Bez potisku; Možnost naklapnutí; Fialová	<a href="http://www.wago.com/2009-145">www.wago.com/2009-145</a> /000-024
	<b>Obj. č.: 210-110</b> Popisovač	<a href="http://www.wago.com/210-110">www.wago.com/210-110</a>
	<b>Obj. č.: 248-501</b> Systém rychlého popisování Mini-WSB; Bez potisku; Šířka štítků 5 mm; 10 řad po 10 štítků na každé kartě	<a href="http://www.wago.com/248-501">www.wago.com/248-501</a>
	<b>Obj. č.: 248-501/000-002</b> Popisovací karta Mini-WSB; Jako karta; Neflexibilní; Bez potisku; Možnost naklapnutí; Žlutá	<a href="http://www.wago.com/248-501">www.wago.com/248-501</a> /000-002
	<b>Obj. č.: 248-501/000-005</b> Popisovací karta Mini-WSB; Jako karta; Neflexibilní; Bez potisku; Možnost naklapnutí; Červená	<a href="http://www.wago.com/248-501">www.wago.com/248-501</a> /000-005
	<b>Obj. č.: 248-501/000-006</b> Popisovací karta Mini-WSB; Jako karta; Neflexibilní; Bez potisku; Možnost naklapnutí; Modrá	<a href="http://www.wago.com/248-501">www.wago.com/248-501</a> /000-006
	<b>Obj. č.: 248-501/000-007</b> Popisovací karta Mini-WSB; Jako karta; Neflexibilní; Bez potisku; Možnost naklapnutí; Šedá	<a href="http://www.wago.com/248-501">www.wago.com/248-501</a> /000-007
	<b>Obj. č.: 248-501/000-012</b> Popisovací karta Mini-WSB; Jako karta; Neflexibilní; Bez potisku; Možnost naklapnutí; Oranžová	<a href="http://www.wago.com/248-501">www.wago.com/248-501</a> /000-012



**Obj. č.: 248-501/000-017**  
Popisovací karta Mini-WSB; Jako karta; Neflexibilní; Bez potisku; Možnost naklapnutí; Světle zelená

[www.wago.com/248-501/000-017](http://www.wago.com/248-501/000-017)



**Obj. č.: 248-501/000-023**  
Popisovací karta Mini-WSB; Jako karta; Neflexibilní; Bez potisku; Možnost naklapnutí; Zelená

[www.wago.com/248-501/000-023](http://www.wago.com/248-501/000-023)



**Obj. č.: 248-501/000-024**  
Popisovací karta Mini-WSB; Jako karta; Neflexibilní; Bez potisku; Možnost naklapnutí; Fialová

[www.wago.com/248-501/000-024](http://www.wago.com/248-501/000-024)



**Obj. č.: 248-502**  
Popisovací karta Mini-WSB; Jako karta; S potiskem; 1–10 (10×); Neflexibilní; Potisk vodorovný; Možnost naklapnutí; Bílá

[www.wago.com/248-502](http://www.wago.com/248-502)



**Obj. č.: 248-502/000-024**  
Popisovací karta Mini-WSB; Jako karta; S potiskem; 1–10 (10×); Neflexibilní; Potisk vodorovný; Možnost naklapnutí; Fialová

[www.wago.com/248-502/000-024](http://www.wago.com/248-502/000-024)



**Obj. č.: 248-503**  
Popisovací karta Mini-WSB; Jako karta; S potiskem; 11–20 (10×); Neflexibilní; Potisk vodorovný; Možnost naklapnutí; Bílá

[www.wago.com/248-503](http://www.wago.com/248-503)



**Obj. č.: 248-503/000-024**  
Popisovací karta Mini-WSB; Jako karta; S potiskem; 11–20 (10×); Neflexibilní; Potisk vodorovný; Možnost naklapnutí; Fialová

[www.wago.com/248-503/000-024](http://www.wago.com/248-503/000-024)



**Obj. č.: 248-504**  
Popisovací karta Mini-WSB; Jako karta; S potiskem; 21–30 (10×); Neflexibilní; Potisk vodorovný; Možnost naklapnutí; Bílá

[www.wago.com/248-504](http://www.wago.com/248-504)



**Obj. č.: 248-504/000-024**  
Popisovací karta Mini-WSB; Jako karta; S potiskem; 21–30 (10×); Neflexibilní; Potisk vodorovný; Možnost naklapnutí; Fialová

[www.wago.com/248-504/000-024](http://www.wago.com/248-504/000-024)



**Obj. č.: 248-505/000-024**  
Mini-WSB marking card; as card; MARKED; 31 ... 40 (10x); not stretchable; Horizontal marking; snap-on type; violet

[www.wago.com/248-505/000-024](http://www.wago.com/248-505/000-024)



**Obj. č.: 248-506**  
Popisovací karta Mini-WSB; Jako karta; S potiskem; 41–50 (10×); Neflexibilní; Potisk vodorovný; Možnost naklapnutí; Bílá

[www.wago.com/248-506](http://www.wago.com/248-506)

#### tools



**Obj. č.: 210-720**  
Ovládací nástroj; Břit: 3,5 × 0,5 mm; S částečně izolovanou rukojetí

[www.wago.com/210-720](http://www.wago.com/210-720)

#### End plate



**Obj. č.: 859-525**  
Koncová bočnice a separátor; Tloušťka 1 mm; Šedá

[www.wago.com/859-525](http://www.wago.com/859-525)

#### Jumper















**Obj. č.: 859-402**  
Hřebenový můstek; 2×; Jmenovitý proud 18 A; Izolováno; Světle šedá

















[www.wago.com/859-402](http://www.wago.com/859-402)



**Obj. č.: 859-402/000-005**  
Hřebenový můstek; 2×; Jmenovitý proud 18 A; Izolováno; Červená

[www.wago.com/859-402/000-005](http://www.wago.com/859-402/000-005)

	<b>Obj. č.: 859-402/000-006</b> Hřebenový můstek; 2×; Jmenovitý proud 18 A; Izolováno; Modrá	<a href="http://www.wago.com/859-402/000-006">www.wago.com/859-402/000-006</a>
	<b>Obj. č.: 859-402/000-029</b> Hřebenový můstek; 2×; Jmenovitý proud 18 A; Izolováno; Žlutá	<a href="http://www.wago.com/859-402/000-029">www.wago.com/859-402/000-029</a>
	<b>Obj. č.: 859-403</b> Hřebenový můstek; 3×; Jmenovitý proud 18 A; Izolováno; Světle šedá	<a href="http://www.wago.com/859-403">www.wago.com/859-403</a>
	<b>Obj. č.: 859-403/000-005</b> Hřebenový můstek; 3×; Jmenovitý proud 18 A; Izolováno; Červená	<a href="http://www.wago.com/859-403/000-005">www.wago.com/859-403/000-005</a>
	<b>Obj. č.: 859-403/000-006</b> Hřebenový můstek; 3×; Jmenovitý proud 18 A; Izolováno; Modrá	<a href="http://www.wago.com/859-403/000-006">www.wago.com/859-403/000-006</a>
	<b>Obj. č.: 859-403/000-029</b> Hřebenový můstek; 3×; Jmenovitý proud 18 A; Izolováno; Žlutá	<a href="http://www.wago.com/859-403/000-029">www.wago.com/859-403/000-029</a>
	<b>Obj. č.: 859-404</b> Hřebenový můstek; 4×; Jmenovitý proud 18 A; Izolováno; Světle šedá	<a href="http://www.wago.com/859-404">www.wago.com/859-404</a>
	<b>Obj. č.: 859-404/000-005</b> Hřebenový můstek; 4×; Jmenovitý proud 18 A; Izolováno; Červená	<a href="http://www.wago.com/859-404/000-005">www.wago.com/859-404/000-005</a>
	<b>Obj. č.: 859-404/000-006</b> Hřebenový můstek; 4×; Jmenovitý proud 18 A; Izolováno; Modrá	<a href="http://www.wago.com/859-404/000-006">www.wago.com/859-404/000-006</a>
	<b>Obj. č.: 859-404/000-029</b> Hřebenový můstek; 4×; Jmenovitý proud 18 A; Izolováno; Žlutá	<a href="http://www.wago.com/859-404/000-029">www.wago.com/859-404/000-029</a>
	<b>Obj. č.: 859-405</b> Hřebenový můstek; 5×; Jmenovitý proud 18 A; Izolováno; Světle šedá	<a href="http://www.wago.com/859-405">www.wago.com/859-405</a>
	<b>Obj. č.: 859-405/000-005</b> Hřebenový můstek; 5×; Jmenovitý proud 18 A; Izolováno; Červená	<a href="http://www.wago.com/859-405/000-005">www.wago.com/859-405/000-005</a>
	<b>Obj. č.: 859-405/000-006</b> Hřebenový můstek; 5×; Jmenovitý proud 18 A; Izolováno; Modrá	<a href="http://www.wago.com/859-405/000-006">www.wago.com/859-405/000-006</a>
	<b>Obj. č.: 859-405/000-029</b> Hřebenový můstek; 5×; Jmenovitý proud 18 A; Izolováno; Žlutá	<a href="http://www.wago.com/859-405/000-029">www.wago.com/859-405/000-029</a>
	<b>Obj. č.: 859-406</b> Hřebenový můstek; 6×; Jmenovitý proud 18 A; Izolováno; Světle šedá	<a href="http://www.wago.com/859-406">www.wago.com/859-406</a>
	<b>Obj. č.: 859-406/000-005</b> Hřebenový můstek; 6×; Jmenovitý proud 18 A; Izolováno; Červená	<a href="http://www.wago.com/859-406/000-005">www.wago.com/859-406/000-005</a>

	<b>Obj. č.: 859-406/000-006</b> Hřebenový můstek; 6×; Jmenovitý proud 18 A; Izolováno; Modrá	<a href="http://www.wago.com/859-406/000-006">www.wago.com/859-406/000-006</a>
	<b>Obj. č.: 859-406/000-029</b> Push-in type jumper bar; 6-way; Nominal current 18 A; insulated; yellow	<a href="http://www.wago.com/859-406/000-029">www.wago.com/859-406/000-029</a>
	<b>Obj. č.: 859-407</b> Hřebenový můstek; 7×; Jmenovitý proud 18 A; Izolováno; Světle šedá	<a href="http://www.wago.com/859-407">www.wago.com/859-407</a>
	<b>Obj. č.: 859-407/000-005</b> Hřebenový můstek; 7×; Jmenovitý proud 18 A; Izolováno; Červená	<a href="http://www.wago.com/859-407/000-005">www.wago.com/859-407/000-005</a>
	<b>Obj. č.: 859-407/000-006</b> Hřebenový můstek; 7×; Jmenovitý proud 18 A; Izolováno; Modrá	<a href="http://www.wago.com/859-407/000-006">www.wago.com/859-407/000-006</a>
	<b>Obj. č.: 859-407/000-029</b> Hřebenový můstek; 7×; Jmenovitý proud 18 A; Izolováno; Žlutá	<a href="http://www.wago.com/859-407/000-029">www.wago.com/859-407/000-029</a>
	<b>Obj. č.: 859-408</b> Hřebenový můstek; 8×; Jmenovitý proud 18 A; Izolováno; Světle šedá	<a href="http://www.wago.com/859-408">www.wago.com/859-408</a>
	<b>Obj. č.: 859-408/000-005</b> Hřebenový můstek; 8×; Jmenovitý proud 18 A; Izolováno; Červená	<a href="http://www.wago.com/859-408/000-005">www.wago.com/859-408/000-005</a>
	<b>Obj. č.: 859-408/000-006</b> Hřebenový můstek; 8×; Jmenovitý proud 18 A; Izolováno; Modrá	<a href="http://www.wago.com/859-408/000-006">www.wago.com/859-408/000-006</a>
	<b>Obj. č.: 859-408/000-029</b> Hřebenový můstek; 8×; Jmenovitý proud 18 A; Izolováno; Žlutá	<a href="http://www.wago.com/859-408/000-029">www.wago.com/859-408/000-029</a>
	<b>Obj. č.: 859-409</b> Hřebenový můstek; 9×; Jmenovitý proud 18 A; Izolováno; Světle šedá	<a href="http://www.wago.com/859-409">www.wago.com/859-409</a>
	<b>Obj. č.: 859-409/000-005</b> Hřebenový můstek; 9×; Jmenovitý proud 18 A; Izolováno; Červená	<a href="http://www.wago.com/859-409/000-005">www.wago.com/859-409/000-005</a>
	<b>Obj. č.: 859-409/000-006</b> Hřebenový můstek; 9×; Jmenovitý proud 18 A; Izolováno; Modrá	<a href="http://www.wago.com/859-409/000-006">www.wago.com/859-409/000-006</a>
	<b>Obj. č.: 859-409/000-029</b> Hřebenový můstek; 9×; Jmenovitý proud 18 A; Izolováno; Žlutá	<a href="http://www.wago.com/859-409/000-029">www.wago.com/859-409/000-029</a>
	<b>Obj. č.: 859-410</b> Hřebenový můstek; 10×; Jmenovitý proud 18 A; Izolováno; Světle šedá	<a href="http://www.wago.com/859-410">www.wago.com/859-410</a>
	<b>Obj. č.: 859-410/000-005</b> Hřebenový můstek; 10×; Jmenovitý proud 18 A; Izolováno; Červená	<a href="http://www.wago.com/859-410/000-005">www.wago.com/859-410/000-005</a>

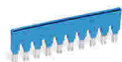

**Obj. č.: 859-410/000-006**  
Hřebenový můstek; 10×; Jmenovitý proud 18 A; Izolováno; Modrá

[www.wago.com/859-410/000-006](http://www.wago.com/859-410/000-006)



**Obj. č.: 859-410/000-029**  
Hřebenový můstek; 10×; Jmenovitý proud 18 A; Izolováno; Žlutá

[www.wago.com/859-410/000-029](http://www.wago.com/859-410/000-029)

#### ferrule



**Obj. č.: 216-221**  
Ferrule; Sleeve for 0.5 mm<sup>2</sup> / 20 AWG; insulated; electro-tin plated; white

[www.wago.com/216-221](http://www.wago.com/216-221)



**Obj. č.: 216-222**  
Ferrule; Sleeve for 0.75 mm<sup>2</sup> / 18 AWG; insulated; electro-tin plated; gray

[www.wago.com/216-222](http://www.wago.com/216-222)



**Obj. č.: 216-223**  
Dutinka; Objímka na 1 mm<sup>2</sup> / AWG 18; S plastovým límcem; Galvanicky pocínováno; Červená

[www.wago.com/216-223](http://www.wago.com/216-223)



**Obj. č.: 216-224**  
Dutinka; Objímka na 1,5 mm<sup>2</sup> / AWG 16; S plastovým límcem; Galvanicky pocínováno; Černá

[www.wago.com/216-224](http://www.wago.com/216-224)

**Obj. č.: 216-321**  
Dutinka; Objímka na 0,25 mm<sup>2</sup> / AWG 24; S plastovým límcem; Galvanicky pocínováno; Žlutá

[www.wago.com/216-321](http://www.wago.com/216-321)



**Obj. č.: 216-322**  
Ferrule; Sleeve for 0.34 mm<sup>2</sup> / 22 AWG; insulated; electro-tin plated; green

[www.wago.com/216-322](http://www.wago.com/216-322)

#### check



**Obj. č.: 859-500**  
Zkušební hrot; Ø 1 mm; Zkušební vodič k připájení

[www.wago.com/859-500](http://www.wago.com/859-500)

#### Ke stažení

##### Documentation

##### Instruction Leaflet

Relay modules, Optocoupler modules	V 1.2.0 30-Aug-2019	pdf 2,2 MB	Stáhnout
------------------------------------	------------------------	---------------	----------

##### Additional Information

Disposal; Electrical and electronic equipment, Packaging	V 1.0.0	pdf 265,8 kB	Stáhnout
--	---------	-----------------	----------

#### CAD/CAE-Data

##### CAD data

2D/3D Models 859-793	URL	Stáhnout
----------------------	-----	----------

##### CAE data

EPLAN Data Portal 859-793	Stáhnout
---------------------------	----------



## Handling Instructions

### Inserting a conductor

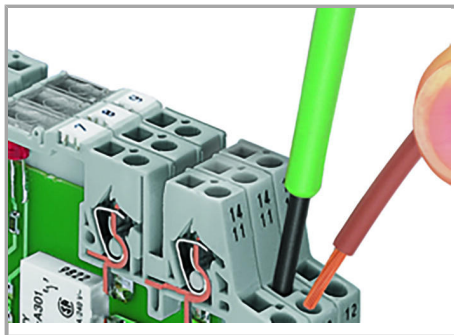

Connection of conductor

### Jumpered

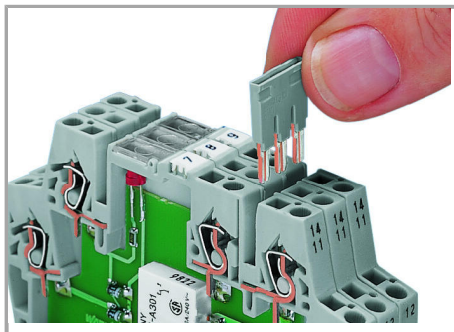

Easy commoning using adjacent jumpers

### Marking



Marking using miniature WSB quick marking card  
Změny vyhrazeny.