

Datový list | Objednací číslo: 859-708

Modul s optočlenem; Vstupní jmenovité napětí DC 24 V; Rozsah výstupního napětí DC 0–24 V; Mezní trvalý proud 0,5 A; Frekvence 10 kHz; Šedá

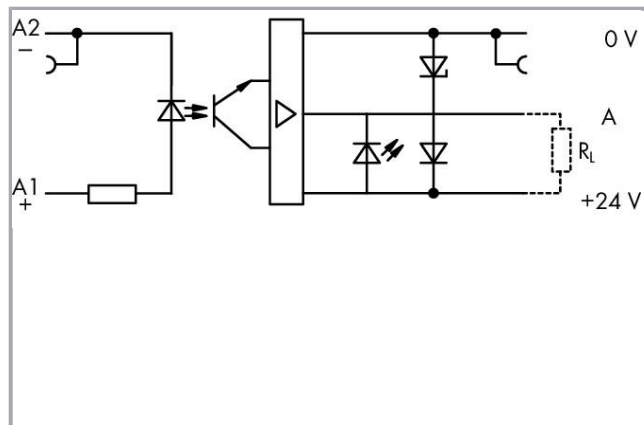

www.wago.com/859-708

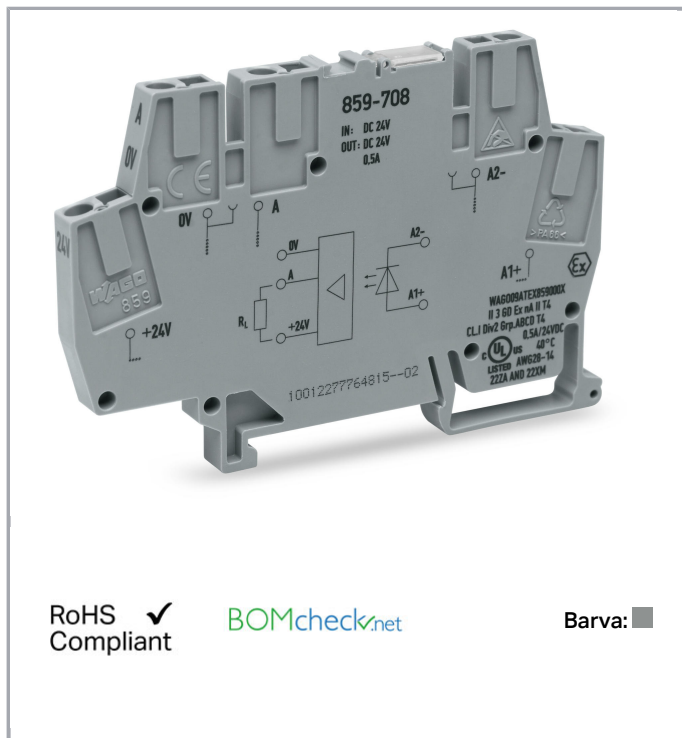

RoHS Compliant ✓

[BOMcheck.net](https://www.bomcheck.net)

Barva: ■

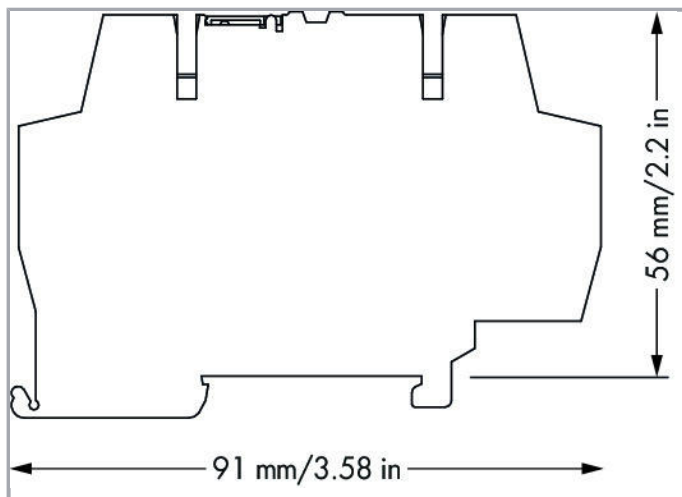

Popis položky

Upozornění:

Optocouplers and solid state relays are designed for use in signal processing networks, which are not supplied by the low-voltage power supply networks.

**Data****Technické údaje****Řídicí obvod:**

Nominal input voltage U_N	DC 24 V
Input voltage range (low level)	DC 0 ... 5 V
Input voltage range (high level)	DC 19 ... 30 V
Jmenovitý vstupní proud I_N	7,7 mA

Zátěžový obvod:

Druh obvodu	3vodičové připojení Spínání k minusu
Limiting continuous current	0,5 A
Output voltage range	DC 20 ... 30 V
Max. voltage drop at output	\leq DC 1,2 V
Leakage current at nominal voltage	\leq 10 μ A
Max. output (reverse current)	11 mA
Doba zapnutí	\leq 10 μ s
Drop-out time	\leq 10 μ s
Switching frequency	\leq 10 kHz

Signaling

Indikace stavu	LED red
----------------	---------

Bezpečnost a ochrana:

Dielectric strength, control/load circuit (AC, 1 min)	2,5 kVrms
---	-----------

Údaje o připojení

Připojovací technika	CAGE CLAMP®
Plný vodič	0,08 ... 2,5 mm ² / 28 ... 14 AWG
Jemně laněný vodič	0,08 ... 2,5 mm ² / 28 ... 14 AWG
Délka odizolování	5 ... 6 mm / 0.2 ... 0.24 palec

Geometrické údaje

Šířka	6 mm / 0.236 inch
Výška od horní hrany lišty DIN 35	56 mm / 2.205 inch
Hloubka	91 mm / 3.583 inch

Mechanické parametry

Způsob montáže	Lišta DIN 35
----------------	--------------

Údaje o materiálu

barva	Šedá
Hmotnost	18.4 g

Okolní podmínky

Přípustná okolní teplota při provozu při U_N	-25 ... 55 °C
Okolní teplota (skladování)	-40 ... 70 °C
Processing temperature	-25 ... +50 °C

Standardy a technické údaje

Normy/ustanovení	EN 60664-1; EN 61000-6-2; EN 61000-6-3; EN 61373; UL 508
------------------	--

Obchodní údaje

Product Group	6 (Interface Electronics)
Druh balení	BOX
Country of origin	DE
GTIN	4055143604727
Customs Tariff No.	85365005000

Atesty/certifikáty

Atesty UL

Logo	Schválení	Doplňkový text schválení	Název certifikátu
	UL UL International Netherlands B.V. (ORDINARY LOCATIONS)	UL 508	E175199 Sec.4

Kompatibilní produkty

tools



Obj. č.: 210-720
Ovládací nástroj; Břit: 3,5 × 0,5 mm; S částečně izolovanou rukojetí

www.wago.com/210-720

check



Obj. č.: 859-500
Zkušební hrot; Ø 1 mm; Zkušební vodič k připojení

www.wago.com/859-500

Marking accessories



Obj. č.: 2009-145
Mini-WSB Inline; Pro Smart Printer; Na cívce; Flexibilní, 5–5,2 mm; Bez potisku; Možnost naklapnutí; Bílá

www.wago.com/2009-145



Obj. č.: 2009-145/000-002
Mini-WSB Inline; Pro Smart Printer; Na cívce; Flexibilní, 5–5,2 mm; Bez potisku; Možnost naklapnutí; Žlutá /000-002

www.wago.com/2009-145



Obj. č.: 2009-145/000-005
Mini-WSB Inline; Pro Smart Printer; Na cívce; Flexibilní, 5–5,2 mm; Bez potisku; Možnost naklapnutí; Červená

www.wago.com/2009-145
[/000-005](http://www.wago.com/2009-145/000-005)



Obj. č.: 2009-145/000-006
Mini-WSB Inline; Pro Smart Printer; Na cívce; Flexibilní, 5–5,2 mm; Bez potisku; Možnost naklapnutí; Modrá

www.wago.com/2009-145
[/000-006](http://www.wago.com/2009-145/000-006)



Obj. č.: 2009-145/000-007
Mini-WSB Inline; Pro Smart Printer; Na cívce; Flexibilní, 5–5,2 mm; Bez potisku; Možnost naklapnutí; Šedá /000-007

www.wago.com/2009-145



Obj. č.: 2009-145/000-012
Mini-WSB Inline; Pro Smart Printer; Na cívce; Flexibilní, 5–5,2 mm; Bez potisku; Možnost naklapnutí; Oranžová

www.wago.com/2009-145
[/000-012](http://www.wago.com/2009-145/000-012)



Obj. č.: 2009-145/000-023
Mini-WSB Inline; Pro Smart Printer; Na cívce; Flexibilní, 5–5,2 mm; Bez potisku; Možnost naklapnutí; Zelená

www.wago.com/2009-145
[/000-023](http://www.wago.com/2009-145/000-023)



Obj. č.: 2009-145/000-024
Mini-WSB Inline; Pro Smart Printer; Na cívce; Flexibilní, 5–5,2 mm; Bez potisku; Možnost naklapnutí; Fialová

www.wago.com/2009-145
[/000-024](http://www.wago.com/2009-145/000-024)



Obj. č.: 210-110
Popisovač

www.wago.com/210-110



Obj. č.: 248-501
Systém rychlého popisování Mini-WSB; Bez potisku; Šířka štítků 5 mm; 10 řad po 10 štítcích na každé kartě

www.wago.com/248-501



Obj. č.: 248-501/000-002
Popisovací karta Mini-WSB; Jako karta; Neflexibilní; Bez potisku; Možnost naklapnutí; Žlutá

www.wago.com/248-501
[/000-002](http://www.wago.com/248-501/000-002)



Obj. č.: 248-501/000-005
Popisovací karta Mini-WSB; Jako karta; Neflexibilní; Bez potisku; Možnost naklapnutí; Červená

www.wago.com/248-501
[/000-005](http://www.wago.com/248-501/000-005)



Obj. č.: 248-501/000-006
Popisovací karta Mini-WSB; Jako karta; Neflexibilní; Bez potisku; Možnost naklapnutí; Modrá

www.wago.com/248-501
[/000-006](http://www.wago.com/248-501/000-006)



Obj. č.: 248-501/000-007
Popisovací karta Mini-WSB; Jako karta; Neflexibilní; Bez potisku; Možnost naklapnutí; Šedá

www.wago.com/248-501/000-007



Obj. č.: 248-501/000-012
Popisovací karta Mini-WSB; Jako karta; Neflexibilní; Bez potisku; Možnost naklapnutí; Oranžová

www.wago.com/248-501/000-012



Obj. č.: 248-501/000-017
Popisovací karta Mini-WSB; Jako karta; Neflexibilní; Bez potisku; Možnost naklapnutí; Světle zelená

www.wago.com/248-501/000-017



Obj. č.: 248-501/000-023
Popisovací karta Mini-WSB; Jako karta; Neflexibilní; Bez potisku; Možnost naklapnutí; Zelená

www.wago.com/248-501/000-023



Obj. č.: 248-501/000-024
Popisovací karta Mini-WSB; Jako karta; Neflexibilní; Bez potisku; Možnost naklapnutí; Fialová

www.wago.com/248-501/000-024



Obj. č.: 248-502
Popisovací karta Mini-WSB; Jako karta; S potiskem; 1–10 (10×); Neflexibilní; Potisk vodorovný; Možnost naklapnutí; Bílá

www.wago.com/248-502



Obj. č.: 248-502/000-024
Popisovací karta Mini-WSB; Jako karta; S potiskem; 1–10 (10×); Neflexibilní; Potisk vodorovný; Možnost naklapnutí; Fialová

www.wago.com/248-502/000-024



Obj. č.: 248-503
Popisovací karta Mini-WSB; Jako karta; S potiskem; 11–20 (10×); Neflexibilní; Potisk vodorovný; Možnost naklapnutí; Bílá

www.wago.com/248-503



Obj. č.: 248-503/000-024
Popisovací karta Mini-WSB; Jako karta; S potiskem; 11–20 (10×); Neflexibilní; Potisk vodorovný; Možnost naklapnutí; Fialová

www.wago.com/248-503/000-024



Obj. č.: 248-504
Popisovací karta Mini-WSB; Jako karta; S potiskem; 21–30 (10×); Neflexibilní; Potisk vodorovný; Možnost naklapnutí; Bílá

www.wago.com/248-504



Obj. č.: 248-504/000-024
Popisovací karta Mini-WSB; Jako karta; S potiskem; 21–30 (10×); Neflexibilní; Potisk vodorovný; Možnost naklapnutí; Fialová

www.wago.com/248-504/000-024



Obj. č.: 248-505/000-024
Mini-WSB marking card; as card; MARKED; 31 ... 40 (10x); not stretchable; Horizontal marking; snap-on type; violet

www.wago.com/248-505/000-024



Obj. č.: 248-506
Popisovací karta Mini-WSB; Jako karta; S potiskem; 41–50 (10×); Neflexibilní; Potisk vodorovný; Možnost naklapnutí; Bílá

www.wago.com/248-506

ferrule



Obj. č.: 216-221
Ferrule; Sleeve for 0.5 mm² / 20 AWG; insulated; electro-tin plated; white

www.wago.com/216-221

















Obj. č.: 216-222
Ferrule; Sleeve for 0.75 mm² / 18 AWG; insulated; electro-tin plated; gray













www.wago.com/216-222











Obj. č.: 216-223
Dutinka; Objímka na 1 mm² / AWG 18; S plastovým límcem; Galvanicky pocínováno; Červená

www.wago.com/216-223

	Obj. č.: 216-224 Dutinka; Objímka na 1,5 mm ² / AWG 16; S plastovým límcem; Galvanicky pocínováno; Černá	www.wago.com/216-224
	Obj. č.: 216-321 Dutinka; Objímka na 0,25 mm ² / AWG 24; S plastovým límcem; Galvanicky pocínováno; Žlutá	www.wago.com/216-321
	Obj. č.: 216-322 Ferrule; Sleeve for 0.34 mm ² / 22 AWG; insulated; electro-tin plated; green	www.wago.com/216-322
Jumper		
	Obj. č.: 859-402 Hřebenový můstek; 2×; Jmenovitý proud 18 A; Izolováno; Světle šedá	www.wago.com/859-402
	Obj. č.: 859-402/000-005 Hřebenový můstek; 2×; Jmenovitý proud 18 A; Izolováno; Červená	www.wago.com/859-402/000-005
	Obj. č.: 859-402/000-006 Hřebenový můstek; 2×; Jmenovitý proud 18 A; Izolováno; Modrá	www.wago.com/859-402/000-006
	Obj. č.: 859-402/000-029 Hřebenový můstek; 2×; Jmenovitý proud 18 A; Izolováno; Žlutá	www.wago.com/859-402/000-029
	Obj. č.: 859-403 Hřebenový můstek; 3×; Jmenovitý proud 18 A; Izolováno; Světle šedá	www.wago.com/859-403
	Obj. č.: 859-403/000-005 Hřebenový můstek; 3×; Jmenovitý proud 18 A; Izolováno; Červená	www.wago.com/859-403/000-005
	Obj. č.: 859-403/000-006 Hřebenový můstek; 3×; Jmenovitý proud 18 A; Izolováno; Modrá	www.wago.com/859-403/000-006
	Obj. č.: 859-403/000-029 Hřebenový můstek; 3×; Jmenovitý proud 18 A; Izolováno; Žlutá	www.wago.com/859-403/000-029
	Obj. č.: 859-404 Hřebenový můstek; 4×; Jmenovitý proud 18 A; Izolováno; Světle šedá	www.wago.com/859-404
	Obj. č.: 859-404/000-005 Hřebenový můstek; 4×; Jmenovitý proud 18 A; Izolováno; Červená	www.wago.com/859-404/000-005
	Obj. č.: 859-404/000-006 Hřebenový můstek; 4×; Jmenovitý proud 18 A; Izolováno; Modrá	www.wago.com/859-404/000-006
	Obj. č.: 859-404/000-029 Hřebenový můstek; 4×; Jmenovitý proud 18 A; Izolováno; Žlutá	www.wago.com/859-404/000-029
	Obj. č.: 859-405 Hřebenový můstek; 5×; Jmenovitý proud 18 A; Izolováno; Světle šedá	www.wago.com/859-405

	Obj. č.: 859-405/000-005 Hřebenový můstek; 5×; Jmenovitý proud 18 A; Izolováno; Červená	www.wago.com/859-405/000-005
	Obj. č.: 859-405/000-006 Hřebenový můstek; 5×; Jmenovitý proud 18 A; Izolováno; Modrá	www.wago.com/859-405/000-006
	Obj. č.: 859-405/000-029 Hřebenový můstek; 5×; Jmenovitý proud 18 A; Izolováno; Žlutá	www.wago.com/859-405/000-029
	Obj. č.: 859-406 Hřebenový můstek; 6×; Jmenovitý proud 18 A; Izolováno; Světle šedá	www.wago.com/859-406
	Obj. č.: 859-406/000-005 Hřebenový můstek; 6×; Jmenovitý proud 18 A; Izolováno; Červená	www.wago.com/859-406/000-005
	Obj. č.: 859-406/000-006 Hřebenový můstek; 6×; Jmenovitý proud 18 A; Izolováno; Modrá	www.wago.com/859-406/000-006
	Obj. č.: 859-406/000-029 Push-in type jumper bar; 6-way; Nominal current 18 A; insulated; yellow	www.wago.com/859-406/000-029
	Obj. č.: 859-407 Hřebenový můstek; 7×; Jmenovitý proud 18 A; Izolováno; Světle šedá	www.wago.com/859-407
	Obj. č.: 859-407/000-005 Hřebenový můstek; 7×; Jmenovitý proud 18 A; Izolováno; Červená	www.wago.com/859-407/000-005
	Obj. č.: 859-407/000-006 Hřebenový můstek; 7×; Jmenovitý proud 18 A; Izolováno; Modrá	www.wago.com/859-407/000-006
	Obj. č.: 859-407/000-029 Hřebenový můstek; 7×; Jmenovitý proud 18 A; Izolováno; Žlutá	www.wago.com/859-407/000-029
	Obj. č.: 859-408 Hřebenový můstek; 8×; Jmenovitý proud 18 A; Izolováno; Světle šedá	www.wago.com/859-408
	Obj. č.: 859-408/000-005 Hřebenový můstek; 8×; Jmenovitý proud 18 A; Izolováno; Červená	www.wago.com/859-408/000-005
	Obj. č.: 859-408/000-006 Hřebenový můstek; 8×; Jmenovitý proud 18 A; Izolováno; Modrá	www.wago.com/859-408/000-006
	Obj. č.: 859-408/000-029 Hřebenový můstek; 8×; Jmenovitý proud 18 A; Izolováno; Žlutá	www.wago.com/859-408/000-029
	Obj. č.: 859-409 Hřebenový můstek; 9×; Jmenovitý proud 18 A; Izolováno; Světle šedá	www.wago.com/859-409

	Obj. č.: 859-409/000-005 Hřebenový můstek; 9×; Jmenovitý proud 18 A; Izolováno; Červená	www.wago.com/859-409/000-005
	Obj. č.: 859-409/000-006 Hřebenový můstek; 9×; Jmenovitý proud 18 A; Izolováno; Modrá	www.wago.com/859-409/000-006
	Obj. č.: 859-409/000-029 Hřebenový můstek; 9×; Jmenovitý proud 18 A; Izolováno; Žlutá	www.wago.com/859-409/000-029
	Obj. č.: 859-410 Hřebenový můstek; 10×; Jmenovitý proud 18 A; Izolováno; Světle šedá	www.wago.com/859-410
	Obj. č.: 859-410/000-005 Hřebenový můstek; 10×; Jmenovitý proud 18 A; Izolováno; Červená	www.wago.com/859-410/000-005
	Obj. č.: 859-410/000-006 Hřebenový můstek; 10×; Jmenovitý proud 18 A; Izolováno; Modrá	www.wago.com/859-410/000-006
	Obj. č.: 859-410/000-029 Hřebenový můstek; 10×; Jmenovitý proud 18 A; Izolováno; Žlutá	www.wago.com/859-410/000-029
End plate		
	Obj. č.: 859-525 Koncová bočnice a separátor; Tloušťka 1 mm; Šedá	www.wago.com/859-525

Ke stažení

Documentation

Instruction Leaflet

Relay modules, Optocoupler modules	V 1.2.0 30-Aug-2019	pdf 2,2 MB	Stáhnout
------------------------------------	------------------------	---------------	----------

Additional Information

Disposal; Electrical and electronic equipment, Packaging	V 1.0.0	pdf 265,8 kB	Stáhnout
--	---------	-----------------	----------

CAD/CAE-Data

CAD data

2D/3D Models 859-708	URL	Stáhnout
----------------------	-----	----------

CAE data

EPLAN Data Portal 859-708	Stáhnout
---------------------------	----------

Handling Instructions

Inserting a conductor

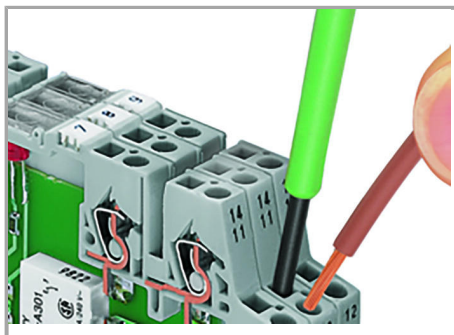

Connection of conductor

Jumpered

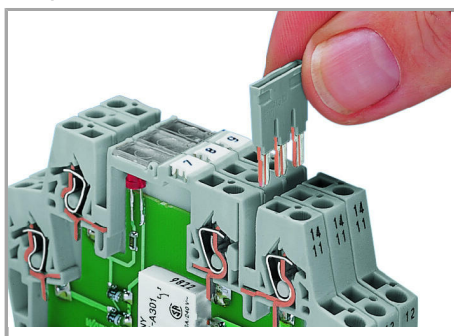

Easy commoning using adjacent jumpers

Marking



Marking using miniature WSB quick marking Značky vyhrazeny.