

Datový list | Objednací číslo: 859-702

Modul s optočlenem; Vstupní jmenovité napětí DC 5 V; Rozsah výstupního napětí DC 0–24 V; Mezní trvalý proud 0,5 A; Frekvence 10 kHz; Konstrukční šířka 6 mm; Šedá

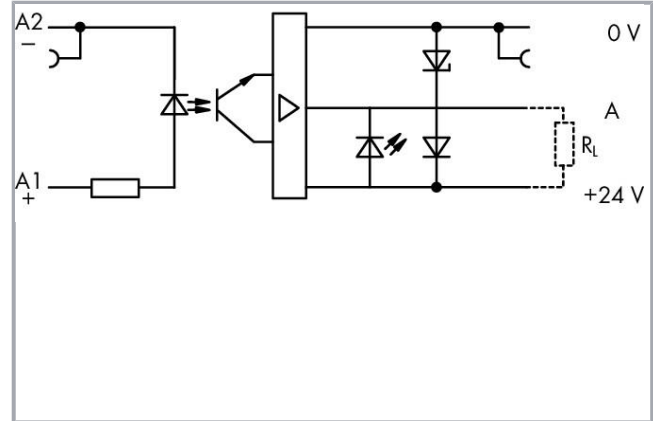

www.wago.com/859-702

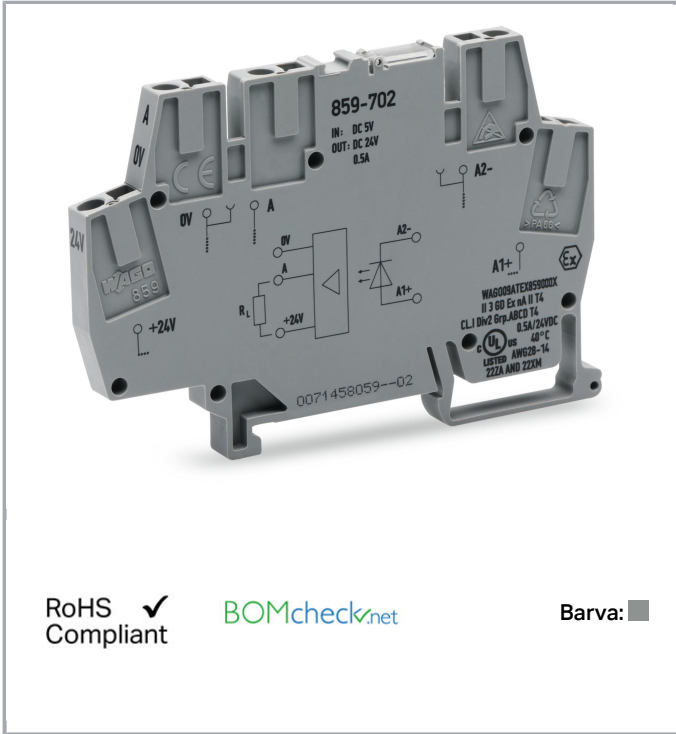

RoHS
Compliant

BOMcheck.net

Barva: ■

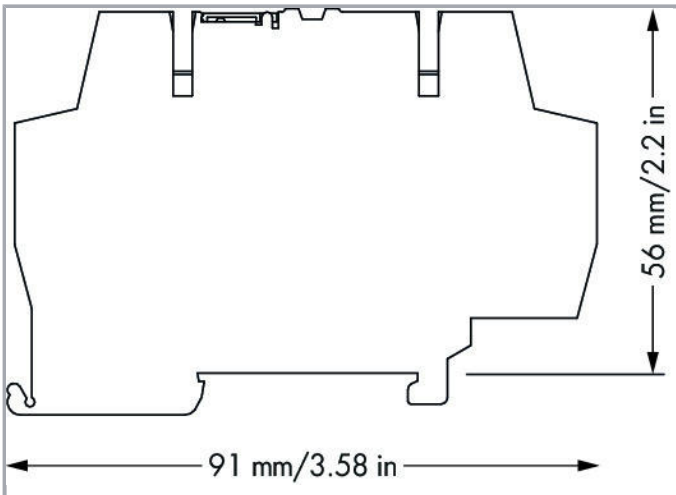

Popis položky

Upozornění:

Optocouplers and solid state relays are designed for use in signal processing networks, which are not supplied by the low-voltage power supply networks.

**Data****Technické údaje****Řídicí obvod:**

Nominal input voltage U_N	DC 5 V
Input voltage range (low level)	DC 0 ... 1 V
Input voltage range (high level)	DC 4 ... 6,25 V
Jmenovitý vstupní proud I_N	9,6 mA

Zátěžový obvod:

Druh obvodu	3vodičové připojení Spínání k minusu
Limiting continuous current	0,5 A
Output voltage range	DC 20 ... 30 V
Max. voltage drop at output	\leq DC 1,2 V
Leakage current at nominal voltage	\leq 10 μ A
Max. output (reverse current)	11 mA
Doba zapnutí	\leq 7 μ s
Drop-out time	\leq 15 μ s
Switching frequency	\leq 10 kHz

Signaling

Indikace stavu	LED red
----------------	---------

Bezpečnost a ochrana:

Dielectric strength, control/load circuit (AC, 1 min)	2,5 kVrms
---	-----------

Údaje o připojení

Připojovací technika	CAGE CLAMP®
Plný vodič	0,08 ... 2,5 mm ² / 28 ... 14 AWG
Jemně laněný vodič	0,08 ... 2,5 mm ² / 28 ... 14 AWG
Délka odizolování	5 ... 6 mm / 0.2 ... 0.24 palec

Geometrické údaje

Šířka	6 mm / 0.236 inch
Výška od horní hrany lišty DIN 35	56 mm / 2.205 inch
Hloubka	91 mm / 3.583 inch

Mechanické parametry

Způsob montáže	Lišta DIN 35
----------------	--------------

Údaje o materiálu

barva	Šedá
Hmotnost	18.3g

Okolní podmínky

Přípustná okolní teplota při provozu při U_N	-25 ... 55 °C
Okolní teplota (skladování)	-40 ... 70 °C
Processing temperature	-25 ... +50 °C

Standardy a technické údaje

Normy/ustanovení	EN 60664-1; EN 61000-6-2; EN 61000-6-3; EN 61373; UL 508
------------------	--

Obchodní údaje

Product Group	6 (Interface Electronics)
Druh balení	BOX
Country of origin	DE
GTIN	4055143604673
Customs Tariff No.	85365005000

Atesty/certifikáty

Atesty UL

Logo	Schválení	Doplňkový text schválení	Název certifikátu
	UL UL International Netherlands B.V. (ORDINARY LOCATIONS)	UL 508	E175199 Sec.4

Kompatibilní produkty

End plate



Obj. č.: 859-525
Koncová bočnice a separátor; Tloušťka 1 mm; Šedá

www.wago.com/859-525

check



Obj. č.: 859-500
Zkušební hrot; Ø 1 mm; Zkušební vodič k připájení

www.wago.com/859-500

ferrule



Obj. č.: 216-221
Ferrule; Sleeve for 0.5 mm² / 20 AWG; insulated; electro-tin plated; white

www.wago.com/216-221



Obj. č.: 216-222
Ferrule; Sleeve for 0.75 mm² / 18 AWG; insulated; electro-tin plated; gray

www.wago.com/216-222



Obj. č.: 216-223
Dutinka; Objímka na 1 mm² / AWG 18; S plastovým límcem; Galvanicky pocínováno; Červená

www.wago.com/216-223



Obj. č.: 216-224
Dutinka; Objímka na 1,5 mm² / AWG 16; S plastovým límcem; Galvanicky pocínováno; Černá

www.wago.com/216-224

Obj. č.: 216-321
Dutinka; Objímka na 0,25 mm² / AWG 24; S plastovým límcem; Galvanicky pocínováno; Žlutá

www.wago.com/216-321



Obj. č.: 216-322
Ferrule; Sleeve for 0.34 mm² / 22 AWG; insulated; electro-tin plated; green

www.wago.com/216-322

Jumper



Obj. č.: 859-402
Hřebenový můstek; 2×; Jmenovitý proud 18 A; Izolováno; Světle šedá

www.wago.com/859-402



Obj. č.: 859-402/000-005
Hřebenový můstek; 2×; Jmenovitý proud 18 A; Izolováno; Červená

www.wago.com/859-402/000-005



Obj. č.: 859-402/000-006
Hřebenový můstek; 2×; Jmenovitý proud 18 A; Izolováno; Modrá

www.wago.com/859-402/000-006



Obj. č.: 859-402/000-029
Hřebenový můstek; 2×; Jmenovitý proud 18 A; Izolováno; Žlutá

www.wago.com/859-402/000-029



Obj. č.: 859-403
Hřebenový můstek; 3×; Jmenovitý proud 18 A; Izolováno; Světle šedá

www.wago.com/859-403



Obj. č.: 859-403/000-005
Hřebenový můstek; 3×; Jmenovitý proud 18 A; Izolováno; Červená

www.wago.com/859-403/000-005



















Obj. č.: 859-403/000-006
Hřebenový můstek; 3×; Jmenovitý proud 18 A; Izolováno; Modrá















www.wago.com/859-403/000-006

















Obj. č.: 859-403/000-029
Hřebenový můstek; 3×; Jmenovitý proud 18 A; Izolováno; Žlutá

www.wago.com/859-403/000-029

	Obj. č.: 859-404 Hřebenový můstek; 4×; Jmenovitý proud 18 A; Izolováno; Světle šedá	www.wago.com/859-404
	Obj. č.: 859-404/000-005 Hřebenový můstek; 4×; Jmenovitý proud 18 A; Izolováno; Červená	www.wago.com/859-404/000-005
	Obj. č.: 859-404/000-006 Hřebenový můstek; 4×; Jmenovitý proud 18 A; Izolováno; Modrá	www.wago.com/859-404/000-006
	Obj. č.: 859-404/000-029 Hřebenový můstek; 4×; Jmenovitý proud 18 A; Izolováno; Žlutá	www.wago.com/859-404/000-029
	Obj. č.: 859-405 Hřebenový můstek; 5×; Jmenovitý proud 18 A; Izolováno; Světle šedá	www.wago.com/859-405
	Obj. č.: 859-405/000-005 Hřebenový můstek; 5×; Jmenovitý proud 18 A; Izolováno; Červená	www.wago.com/859-405/000-005
	Obj. č.: 859-405/000-006 Hřebenový můstek; 5×; Jmenovitý proud 18 A; Izolováno; Modrá	www.wago.com/859-405/000-006
	Obj. č.: 859-405/000-029 Hřebenový můstek; 5×; Jmenovitý proud 18 A; Izolováno; Žlutá	www.wago.com/859-405/000-029
	Obj. č.: 859-406 Hřebenový můstek; 6×; Jmenovitý proud 18 A; Izolováno; Světle šedá	www.wago.com/859-406
	Obj. č.: 859-406/000-005 Hřebenový můstek; 6×; Jmenovitý proud 18 A; Izolováno; Červená	www.wago.com/859-406/000-005
	Obj. č.: 859-406/000-006 Hřebenový můstek; 6×; Jmenovitý proud 18 A; Izolováno; Modrá	www.wago.com/859-406/000-006
	Obj. č.: 859-406/000-029 Push-in type jumper bar; 6-way; Nominal current 18 A; insulated; yellow	www.wago.com/859-406/000-029
	Obj. č.: 859-407 Hřebenový můstek; 7×; Jmenovitý proud 18 A; Izolováno; Světle šedá	www.wago.com/859-407
	Obj. č.: 859-407/000-005 Hřebenový můstek; 7×; Jmenovitý proud 18 A; Izolováno; Červená	www.wago.com/859-407/000-005
	Obj. č.: 859-407/000-006 Hřebenový můstek; 7×; Jmenovitý proud 18 A; Izolováno; Modrá	www.wago.com/859-407/000-006
	Obj. č.: 859-407/000-029 Hřebenový můstek; 7×; Jmenovitý proud 18 A; Izolováno; Žlutá	www.wago.com/859-407/000-029

	Obj. č.: 859-408 Hřebenový můstek; 8×; Jmenovitý proud 18 A; Izolováno; Světle šedá	www.wago.com/859-408
	Obj. č.: 859-408/000-005 Hřebenový můstek; 8×; Jmenovitý proud 18 A; Izolováno; Červená	www.wago.com/859-408/000-005
	Obj. č.: 859-408/000-006 Hřebenový můstek; 8×; Jmenovitý proud 18 A; Izolováno; Modrá	www.wago.com/859-408/000-006
	Obj. č.: 859-408/000-029 Hřebenový můstek; 8×; Jmenovitý proud 18 A; Izolováno; Žlutá	www.wago.com/859-408/000-029
	Obj. č.: 859-409 Hřebenový můstek; 9×; Jmenovitý proud 18 A; Izolováno; Světle šedá	www.wago.com/859-409
	Obj. č.: 859-409/000-005 Hřebenový můstek; 9×; Jmenovitý proud 18 A; Izolováno; Červená	www.wago.com/859-409/000-005
	Obj. č.: 859-409/000-006 Hřebenový můstek; 9×; Jmenovitý proud 18 A; Izolováno; Modrá	www.wago.com/859-409/000-006
	Obj. č.: 859-409/000-029 Hřebenový můstek; 9×; Jmenovitý proud 18 A; Izolováno; Žlutá	www.wago.com/859-409/000-029
	Obj. č.: 859-410 Hřebenový můstek; 10×; Jmenovitý proud 18 A; Izolováno; Světle šedá	www.wago.com/859-410
	Obj. č.: 859-410/000-005 Hřebenový můstek; 10×; Jmenovitý proud 18 A; Izolováno; Červená	www.wago.com/859-410/000-005
	Obj. č.: 859-410/000-006 Hřebenový můstek; 10×; Jmenovitý proud 18 A; Izolováno; Modrá	www.wago.com/859-410/000-006
	Obj. č.: 859-410/000-029 Hřebenový můstek; 10×; Jmenovitý proud 18 A; Izolováno; Žlutá	www.wago.com/859-410/000-029
Marking accessories		
	Obj. č.: 2009-145 Mini-WSB Inline; Pro Smart Printer; Na cívce; Flexibilní, 5–5,2 mm; Bez potisku; Možnost naklapnutí; Bílá	www.wago.com/2009-145
	Obj. č.: 2009-145/000-002 Mini-WSB Inline; Pro Smart Printer; Na cívce; Flexibilní, 5–5,2 mm; Bez potisku; Možnost naklapnutí; Žlutá	www.wago.com/2009-145/000-002
	Obj. č.: 2009-145/000-005 Mini-WSB Inline; Pro Smart Printer; Na cívce; Flexibilní, 5–5,2 mm; Bez potisku; Možnost naklapnutí; Červená	www.wago.com/2009-145/000-005
	Obj. č.: 2009-145/000-006	

	Mini-WSB Inline; Pro Smart Printer; Na cívce; Flexibilní, 5–5,2 mm; Bez potisku; Možnost naklapnutí; Modrá	www.wago.com/2009-145/000-006
	Obj. č.: 2009-145/000-007 Mini-WSB Inline; Pro Smart Printer; Na cívce; Flexibilní, 5–5,2 mm; Bez potisku; Možnost naklapnutí; Šedá	www.wago.com/2009-145/000-007
	Obj. č.: 2009-145/000-012 Mini-WSB Inline; Pro Smart Printer; Na cívce; Flexibilní, 5–5,2 mm; Bez potisku; Možnost naklapnutí; Oranžová	www.wago.com/2009-145/000-012
	Obj. č.: 2009-145/000-023 Mini-WSB Inline; Pro Smart Printer; Na cívce; Flexibilní, 5–5,2 mm; Bez potisku; Možnost naklapnutí; Zelená	www.wago.com/2009-145/000-023
	Obj. č.: 2009-145/000-024 Mini-WSB Inline; Pro Smart Printer; Na cívce; Flexibilní, 5–5,2 mm; Bez potisku; Možnost naklapnutí; Fialová	www.wago.com/2009-145/000-024
	Obj. č.: 210-110 Popisovač	www.wago.com/210-110
	Obj. č.: 248-501 Systém rychlého popisování Mini-WSB; Bez potisku; Šířka štítků 5 mm; 10 řad po 10 štítků na každé kartě	www.wago.com/248-501
	Obj. č.: 248-501/000-002 Popisovací karta Mini-WSB; Jako karta; Neflexibilní; Bez potisku; Možnost naklapnutí; Žlutá	www.wago.com/248-501/000-002
	Obj. č.: 248-501/000-005 Popisovací karta Mini-WSB; Jako karta; Neflexibilní; Bez potisku; Možnost naklapnutí; Červená	www.wago.com/248-501/000-005
	Obj. č.: 248-501/000-006 Popisovací karta Mini-WSB; Jako karta; Neflexibilní; Bez potisku; Možnost naklapnutí; Modrá	www.wago.com/248-501/000-006
	Obj. č.: 248-501/000-007 Popisovací karta Mini-WSB; Jako karta; Neflexibilní; Bez potisku; Možnost naklapnutí; Šedá	www.wago.com/248-501/000-007
	Obj. č.: 248-501/000-012 Popisovací karta Mini-WSB; Jako karta; Neflexibilní; Bez potisku; Možnost naklapnutí; Oranžová	www.wago.com/248-501/000-012
	Obj. č.: 248-501/000-017 Popisovací karta Mini-WSB; Jako karta; Neflexibilní; Bez potisku; Možnost naklapnutí; Světle zelená	www.wago.com/248-501/000-017
	Obj. č.: 248-501/000-023 Popisovací karta Mini-WSB; Jako karta; Neflexibilní; Bez potisku; Možnost naklapnutí; Zelená	www.wago.com/248-501/000-023
	Obj. č.: 248-501/000-024 Popisovací karta Mini-WSB; Jako karta; Neflexibilní; Bez potisku; Možnost naklapnutí; Fialová	www.wago.com/248-501/000-024
	Obj. č.: 248-502	

	Popisovací karta Mini-WSB; Jako karta; S potiskem; 1–10 (10×); Neflexibilní; Potisk vodorovný; Možnost naklapnutí; Bílá	www.wago.com/248-502
	Obj. č.: 248-502/000-024 Popisovací karta Mini-WSB; Jako karta; S potiskem; 1–10 (10×); Neflexibilní; Potisk vodorovný; Možnost naklapnutí; Fialová	www.wago.com/248-502/000-024
	Obj. č.: 248-503 Popisovací karta Mini-WSB; Jako karta; S potiskem; 11–20 (10×); Neflexibilní; Potisk vodorovný; Možnost naklapnutí; Bílá	www.wago.com/248-503
	Obj. č.: 248-503/000-024 Popisovací karta Mini-WSB; Jako karta; S potiskem; 11–20 (10×); Neflexibilní; Potisk vodorovný; Možnost naklapnutí; Fialová	www.wago.com/248-503/000-024
	Obj. č.: 248-504 Popisovací karta Mini-WSB; Jako karta; S potiskem; 21–30 (10×); Neflexibilní; Potisk vodorovný; Možnost naklapnutí; Bílá	www.wago.com/248-504
	Obj. č.: 248-504/000-024 Popisovací karta Mini-WSB; Jako karta; S potiskem; 21–30 (10×); Neflexibilní; Potisk vodorovný; Možnost naklapnutí; Fialová	www.wago.com/248-504/000-024
	Obj. č.: 248-505/000-024 Mini-WSB marking card; as card; MARKED; 31 ... 40 (10x); not stretchable; Horizontal marking; snap-on type; violet	www.wago.com/248-505/000-024
	Obj. č.: 248-506 Popisovací karta Mini-WSB; Jako karta; S potiskem; 41–50 (10×); Neflexibilní; Potisk vodorovný; Možnost naklapnutí; Bílá	www.wago.com/248-506
tools		
	Obj. č.: 210-720 Ovládací nástroj; Břit: 3,5 × 0,5 mm; S částečně izolovanou rukojetí	www.wago.com/210-720

Ke stažení

Documentation

Instruction Leaflet

Relay modules, Optocoupler modules	V 1.2.0 30-Aug-2019	pdf 2,2 MB	Stáhnout
------------------------------------	------------------------	---------------	----------

Additional Information

Disposal; Electrical and electronic equipment, Packaging	V 1.0.0	pdf 265,8 kB	Stáhnout
--	---------	-----------------	----------

CAD/CAE-Data

CAD data

2D/3D Models 859-702	URL	Stáhnout
----------------------	-----	----------

CAE data



EPLAN Data Portal 859-702

[Stáhnout](#)

WSCAD Universe 859-702

[Stáhnout](#)

Handling Instructions

Inserting a conductor

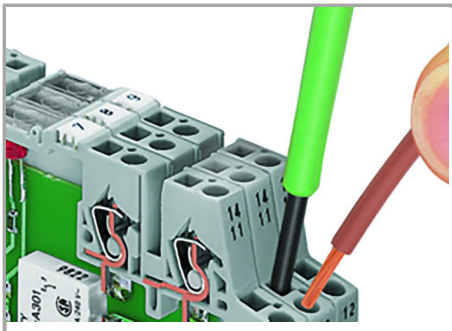

Connection of conductor

Jumpered

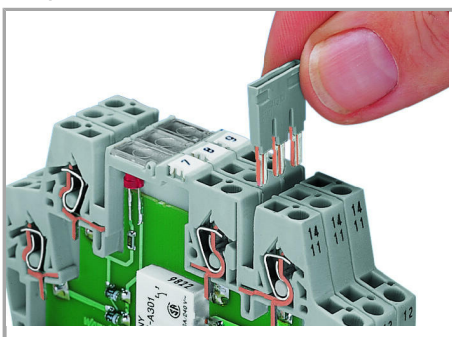

Easy commoning using adjacent jumpers

Marking



Marking using miniature WSB quick marking card

Změny vyhrazeny.

WAGO Elektro spol. sr. o.
Rozvodova 1116/36
143 00 Praha 12 - Modřany
Tel.: +420 261 090 143
Email: info.cz@wago.com, wago-cz@wago.com

Máte otázky ohledně našich produktů?
Kdykoli nám zavolejte na číslo +420 261 090 143.