



## Hlavní parametry

Řada	TeSys
Označení výrobku	TeSys GV4
Označení přístroje	GV4L
Typ produktu nebo součásti	Jistič
Použití zařízení	Motor
Popis pólů	3P
Kategorie použití	Kategorie A
Provedení jednotky spouští	Zkratová
Typ ochrany	Ochrana proti zkratu
[In] jmenovitý proud	2 A
Vypínací schopnost	[Icu] : 100 kA at 220...240 V AC 50/60 Hz according to IEC 60947-2 [Icu] : 50 kA at 380...415 V AC 50/60 Hz according to IEC 60947-2 [Icu] : 50 kA at 440 V AC 50/60 Hz according to IEC 60947-2 [Icu] : 15 kA at 525 V AC 50/60 Hz according to IEC 60947-2 [Icu] : 8 kA at 660...690 V AC 50/60 Hz according to IEC 60947-2 [Icu] : 25 kA at 500 V AC 50/60 Hz according to IEC 60947-2
[Ics] jmenovitá provozní vypínací schopnost	100 kA : při 220...240 V AC 50/60 Hz v souladu s IEC 60947-2 50 kA : při 380...415 V AC 50/60 Hz v souladu s IEC 60947-2 50 kA : při 440 V AC 50/60 Hz v souladu s IEC 60947-2 25 kA : při 500 V AC 50/60 Hz v souladu s IEC 60947-2 15 kA : při 525 V AC 50/60 Hz v souladu s IEC 60947-2 2 kA : at 660...690 V AC 50/60 Hz according to IEC 60947-2
Jmenovitá hodnota jednotky spouští	12...28 A
Typ ovládání	Páčka

## Doplňěk

[Ue] jmenovité pracovní napětí	690 V AC 50/60 Hz podle IEC 60947-2
Výkon motoru (kW)	0,25 kW at 400...415 V AC 50/60 Hz 0,37 kW při 400...415 V AC 50/60 Hz 0,37 kW při 500 V AC 50/60 Hz 0,55 kW při 400...415 V AC 50/60 Hz 0,55 kW při 500 V AC 50/60 Hz 0,75 kW při 400...415 V AC 50/60 Hz 0,75 kW při 500 V AC 50/60 Hz 0,75 kW při 660...690 V AC 50/60 Hz 1,1 kW při 500 V AC 50/60 Hz 1,1 kW při 660...690 V AC 50/60 Hz 1,5 kW při 660...690 V AC 50/60 Hz 0,55 kW at 660...690 V AC 50/60 Hz
[Uimp] jmenovité impulzní výdržné napětí	8 kV according to IEC 60947-2
[Ui] jmenovité izolační napětí	800 V according to IEC 60947-2
Montáž	Příchýtkami Šrouby
Montážní držák	35 mm symetrická DIN lišta 75 mm symetrická DIN lišta

Deska	
Vhodnost pro bezpečné odpojení	Yes according to IEC 60947-1
Mechanická životnost	40000 cycles
Elektrická životnost	40000 cyklu pro AC-3 při 440 V In/2 40000 cycles for AC-3 at 440 V In
Místní signalizace	Zelená vlajka pro presence of auxiliary contacts
Počet slotů	1 slot(y) pro alarm switch kontakt signalizace závady (násuvná) 1 slot(y) pro voltage release vzdálené el. vypnutí (násuvná) 1 slot(s) for auxiliary switch open/close contact (plug-in)
Rozteč pro připojení	27 mm
Připojení - svorky	EverLink BTR screw connectors - location: top socket 1 cable(s) 1.5...70 mm <sup>2</sup> (solid) EverLink BTR screw connectors - location: top socket 1 cable(s) 1.5...50 mm <sup>2</sup> (flexible) EverLink BTR screw connectors - location: bottom socket 1 cable(s) 2.5...95 mm <sup>2</sup> (solid) EverLink BTR screw connectors - location: bottom socket 1 cable(s) 2.5...70 mm <sup>2</sup> (flexible)
Krouticí moment	9 N.m for 16...95 mm <sup>2</sup> 5 N.m for 1.5...10 mm <sup>2</sup>
Délka holého konce vodiče	20 mm
Označení kvality	CE
Standardy	EN/IEC 60947-2 EN/IEC 60947-4-1
Výška	155 mm
Šířka	81 mm
Hloubka	116 mm
Hmotnost přístroje	1,5 kg
Barva	Šedá RAL 7016

## Životní prostředí

certifikace výrobku	IEC
tropikalizace	2 according to IEC 68-2
stupeň krytí IP	IP40 (front face) v souladu s IEC 60529
stupeň ochrany IK	IK07 v souladu s IEC 62262
stupeň znečištění	3 v souladu s IEC 60947-1
mechanická robustnost	Shocks 15 Gn for 11 ms according to IEC 60068-2-27 Vibrations +/- 1 mm for 2...13.2 Hz according to IEC 60068-2-6 Vibrations 0.7 gn for 13.2...100 Hz according to IEC 60068-2-6
teplota okolního vzduchu pro provoz	-25...70 °C
teplota okolí pro uskladnění	-50...85 °C
pracovní nadmožská výška	2000 m bez snížení zatížení > 2000...5000 m with derating

## Nabídka udržitelnosti

udržitelný stav nabídky	Výrobek Green Premium
RoHS	Compliant - since 1736 - Schneider Electric declaration of conformity
REACH	Odkaz neobsahuje SVHC nad mezní hodnotou
dokument o ekologickém profilu	Dostupný
instrukce o ukončení životnosti výrobku	Dostupný

## Contractual warranty

Záruční lhůta	18 měsíců
---------------	-----------

## Tripping Curves for GV4L and GV4LE Combined with Thermal Overload Relay LRD or LR9

### Average Operating Times at 20 °C Related to Multiples of the Setting Current

GV4L02 and GV4LE02 to 12 with LRD05 to LRD14, GV4L80 and GV4LE80 with LRD3363

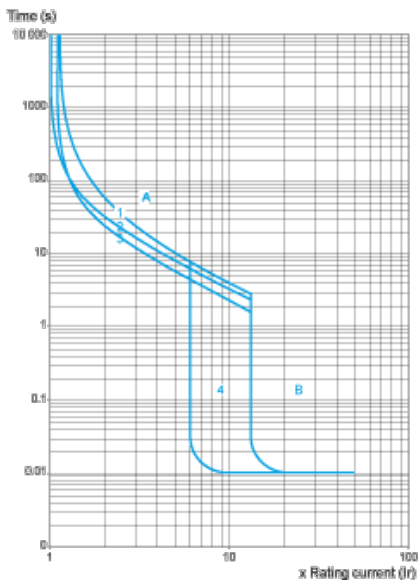

- 1 3 poles from cold state
- 2 2 poles from cold state
- 3 3 poles from hot state
- 4 6...14 Ir
- A Thermal overload relay protection zone
- B GV4L protection zone

GV4L25 and GV4LE25 with LRD 318, LRD325 GV4L50 AND GV4LE50 with LRD 332, LRD 340, LRD 350

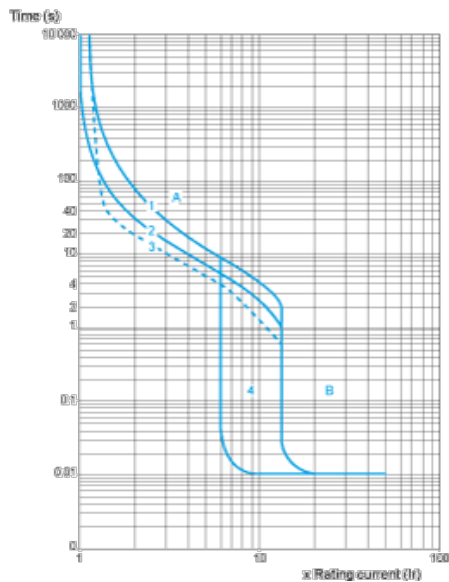

- 1 3 poles from cold state
- 2 2 poles from cold state
- 3 3 poles from hot state
- 4 6...14 Ir
- A Thermal overload relay protection zone
- B GV4L protection zone

GV4L115 and GV4LE115 with Class 10 LR9F5367, LR9D5369 and Class 20 LR9D5567, LR9F5569

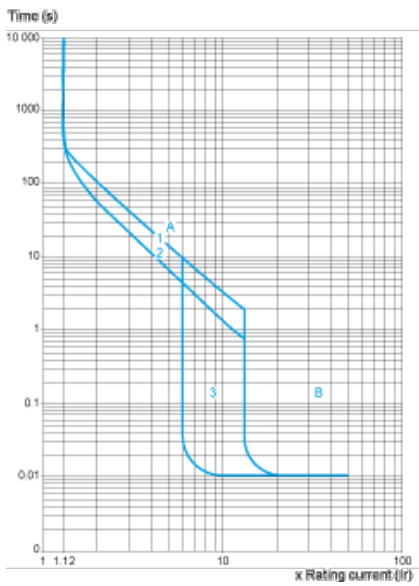

- 1 Cold state curve
- 2 Hot state curve
- 3 6...14 Ir

**Current Limitation on Short-Circuit for GV4L, GV4LE (3-Phase 400/415 V)**

**Dynamic Stress**

$I_{peak} = f(\text{prospective } I_{sc}) \text{ at } 1.05 U_e = 435 \text{ V}$

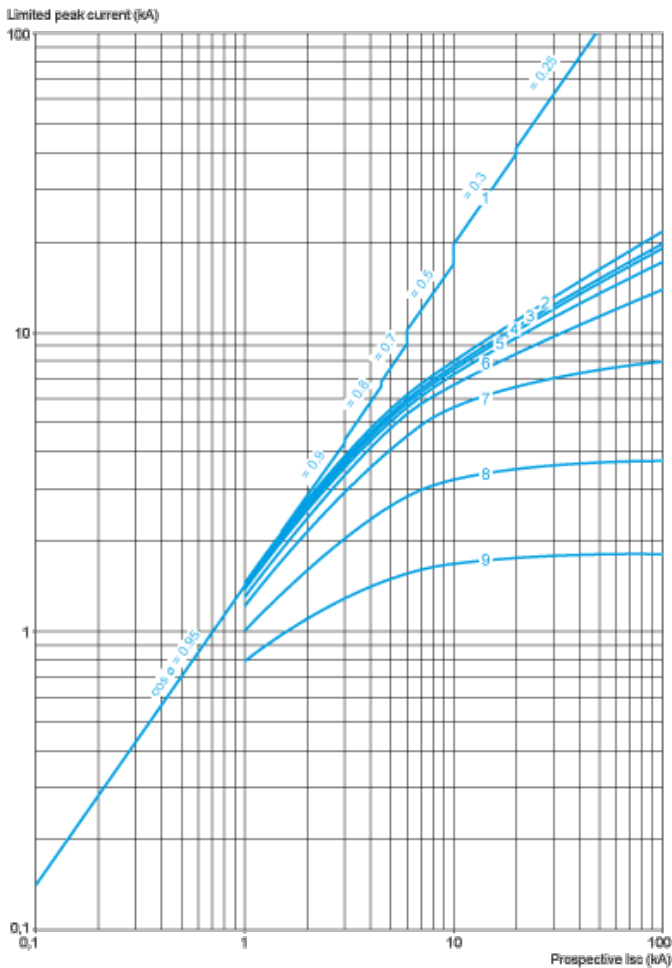

- 1 Maximum peak current
- 2 GV4L115
- 3 GV4L80
- 4 GV4L50
- 5 GV4L25
- 6 GV4L12
- 7 GV4L07

8 GV4L03

9 GV4L02

### Current Limitation on Short-Circuit for GV4L, GV4LE + Thermal Overload Relay LRD or LR9 (3-Phase 400/415 V)

#### Dynamic Stress

$I_{peak} = f(\text{prospective } I_{sc})$  at  $1.05 U_e = 435 \text{ V}$

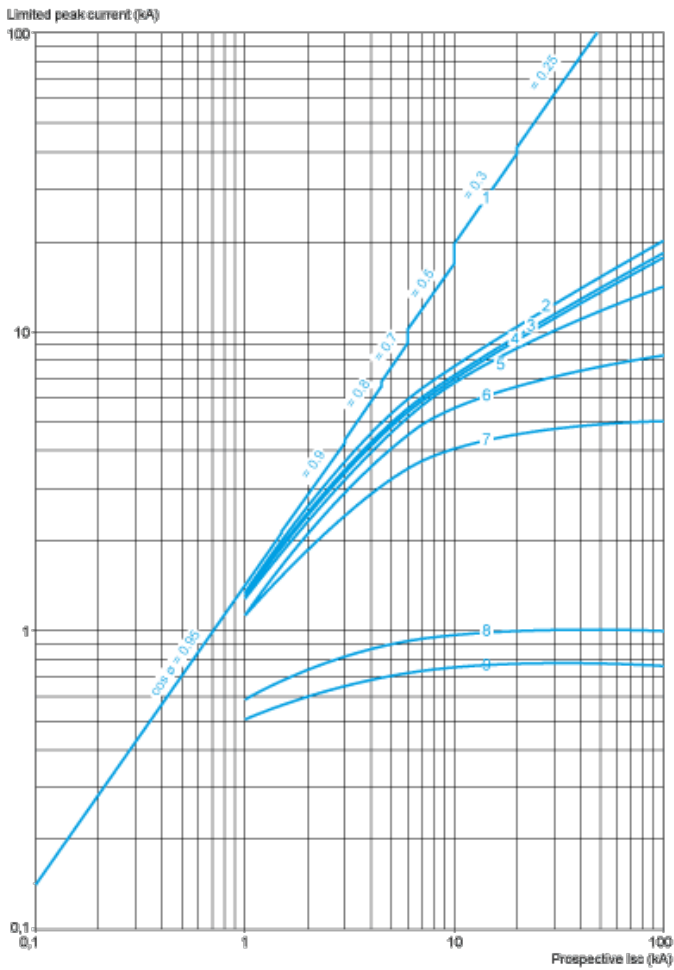

- 1 Maximum peak current
- 2 GV4L115 + LR9D5367 or LR9F5367
- 3 GV4L80 + LRD3361
- 4 GV4L50 + LRD340
- 5 GV4L25 + LRD325
- 6 GV4L12 + LRD313
- 7 GV4L07 + LRD12
- 8 GV4L03 + LRD07
- 9 GV4L02 + LRD07

### Thermal Limit on Short-Circuit for GV4L, GV4LE

#### Thermal Limit in A<sup>2</sup>s

Sum of  $I^2dt = f(\text{prospective } I_{sc})$  at  $1.05 U_e = 435 \text{ V}$

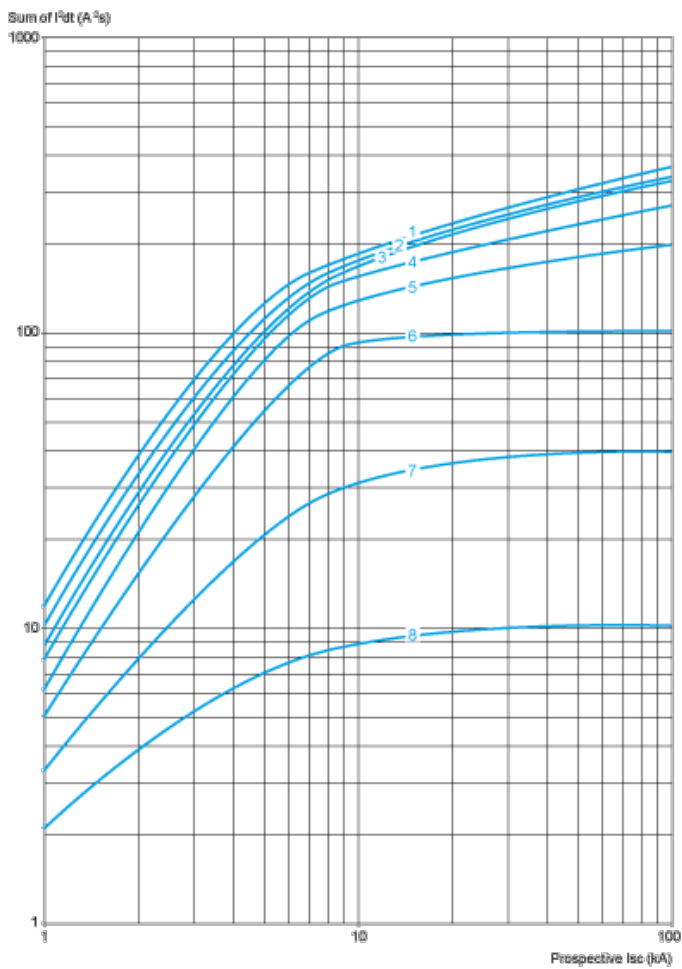

- 1 GV4L115
- 2 GV4L80
- 3 GV4L50
- 4 GV4L25
- 5 GV4L12
- 6 GV4L07
- 7 GV4L03
- 8 GV4L02

**Current Limitation on Short-Circuit for GV4L, GV4LE + Thermal Overload Relay LRD or LR9**

**Thermal Limit in kA in the Magnetic Operating Zone**

Sum of  $I^2dt = f$  (prospective Isc) at  $1.05 U_e = 435 V$

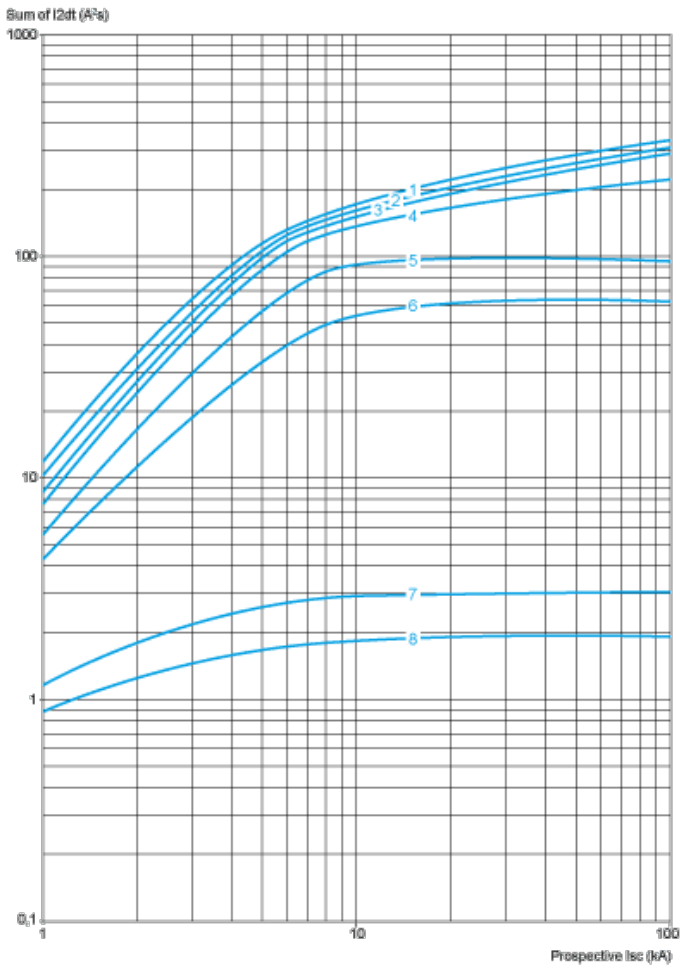

- 1 GV4L115 + LR9D5367 or LR9F5367
- 2 GV4L80 + LRD3361
- 3 GV4L50 + LRD340
- 4 GV4L25 + LRD325
- 5 GV4L12 + LRD313
- 6 GV4L07+ LRD12
- 7 GV4L03+ LRD07
- 8 GV4L02 + LRD07

**GV4 with Toggle: GV4LE, GV4PE, GV4PEM**

With EverLink® Connector

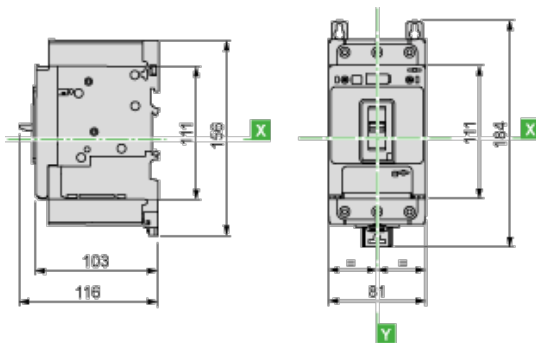

With Crimp Lug Connector

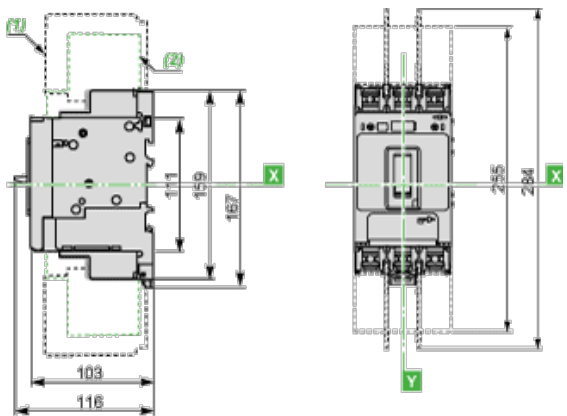

- (1) Interphases barriers
- (2) Long terminal shield

GV4 with Rotary Handle: GV4L, GV4P, or GV4LE, GV4PE, GV4PEM with GV4ADN01, GV4ADN02 Direct Mounting Rotary Handle

Dimensions

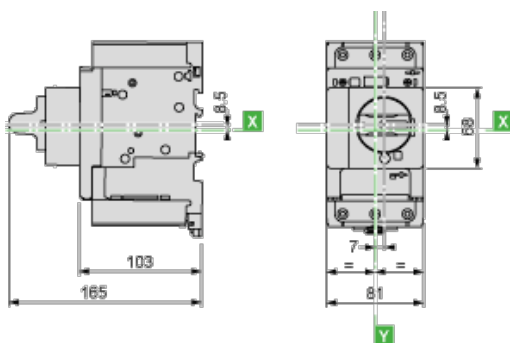

GV4L, GV4P, GV4LE, GV4PE, GV4PEM

Panel Mounting with M4 Screws

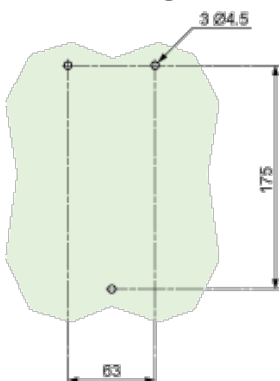

Door Cut-Out for Rotary Handle

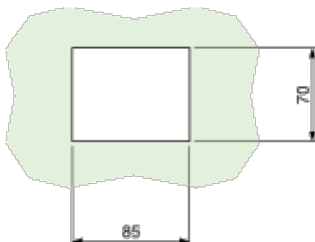

Minimum Safety Clearance



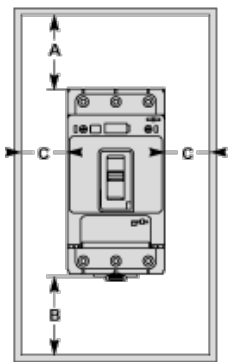

Toggle-type, rotary handle-type: identical clearance values.

Safety Clearance (mm)						
	Painted Sheet Metal			Bare Sheet Metal		
	A	B	C	A	B	C
No accessory	30	0	0	40	0	5
Interphase barriers	0	0	0	0	0	5
Long terminal shield	0	0	0	0	0	5

### Magnetic Motor Circuit Breakers

GV4L, GV4LE

