

**USS**

Určeny pro spínání, ovládání a signalizaci pomocných i silových obvodů.
str. 52

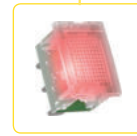

Záslepka

Spínače,
Přepínače,
TlačítkaSpínače
s doutnavkou

Signálky

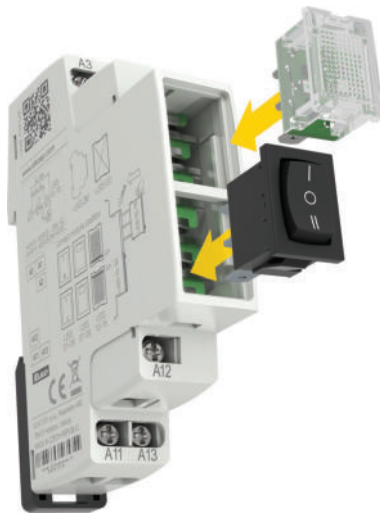
USS | Ovládací a signalizační moduly

- Určeny pro spínání, ovládání a signalizaci pomocných i silových obvodů.
- USS - "Udělej Si Sám" = do základního modulu lze "nacvaknout" různé typy spínačích a signalizačních jednotek.
- Jednotky se dodávají samostatně, jednotlivé konfigurace si provádí uživatel.
- 16 typů jednotek: spínače, přepínače, tlačítka, prosvětlené spínače, různobarevné signálky včetně blikacích.
- Jednotky jsou měnitelné i do budoucna (např. při změně aplikace, rozšíření provozu, ...).
- Do jednoho modulu lze osadit až 2 pozice jednotek (např. 2x přepínač, 2x signálka nebo jejich kombinace) = oproti konkurenci úspora místa v rozvaděči.
- V provedení 1-MODUL (90 x 17,6 x 64 mm), upevnění na DIN lištu.
- Rozsah pracovních teplot přístroje -20 až +55 °C.
- Trmenové svorky, šroub M3 kombinovaná hlava, pozdřivce 1.

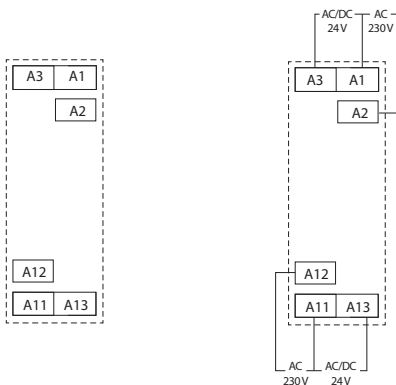
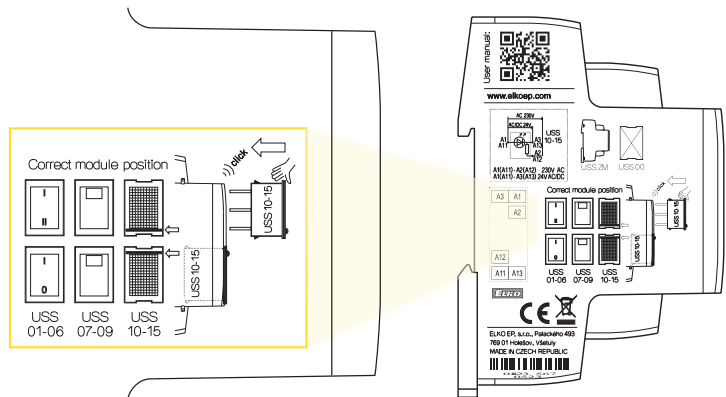
Zapojení svorek**Zapojení svorek signálky****Montáž USS do modulu****Příklady osazení**

USS-01 + USS-03



USS-07 + USS-11



USS-11 + USS-01



USS-10 + USS-00













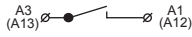

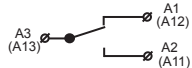
USS-10 + USS-11

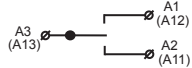

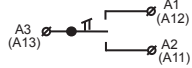

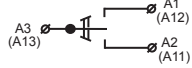

USS-07 + USS-00

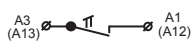
TYPOVÉ OZNAČENÍ	EAN KÓD	ZAPOJENÍ	JMEN. PROUD/NAPĚTÍ (U SPÍNAČŮ) NAPÁJ. NAPĚTÍ (U SIGNÁLEK)	ROZMĚR	POPIS
USS-ZM	8595188124577	MODUL	-	19 x 17.6. x 64 mm	Základní modul (krabička se svorkami a kontakty)
USS-00	8595188124614	ZÁSLEPKA	-	21 x 15 x 7 mm	Slouží pro zaslepení neobsazené pozice jednotky



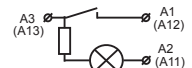

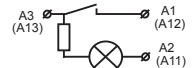

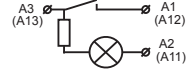





Spínače, přepínače, tlačítka

USS-01		8595188124621		6A/250 V AC	21 x 15 x 20 mm	Spínač
USS-02		8595188124638		10 A/250 V AC	21 x 15 x 20 mm	Přepínač
USS-03		8595188124645		10 A/250 V AC	21 x 15 x 20 mm	Přepínač se střední polohou
USS-04		8595188124652		6 A/250 V AC	21 x 15 x 20 mm	Spínač + tlačítko se střední polohou
USS-05		8595188124669		6 A/250 V AC	21 x 15 x 20 mm	Přepínací tlačítko se střední polohou
USS-06/S		8595188124676		10 A/250 V AC	21 x 15 x 20 mm	Tlačítko spínací
USS-06/R		8595188136372		10 A/250 V AC	21 x 15 x 20 mm	Tlačítko rozpínací

Spínače s doutnavkou

USS-07		8595188124683		6 A/250 V AC	21 x 15 x 20 mm	Spínač s doutnavkou (červená)
USS-08		8595188124690		6 A/250 V AC	21 x 15 x 20 mm	Spínač s doutnavkou (zelená)
USS-09		8595188124706		6 A/250 V AC	21 x 15 x 20 mm	Spínač s doutnavkou (žlutá)

Signálky

USS-10		8595188124331		A1-A2, AC 230 V A1-A3, AC/DC 24 V	21 x 15 x 14 mm	Signální LED (červená)
USS-11		8595188124348		A1-A2, AC 230 V A1-A3, AC/DC 24 V	21 x 15 x 14 mm	Signální LED (zelená)
USS-12		8595188124355		A1-A2, AC 230 V A1-A3, AC/DC 24 V	21 x 15 x 14 mm	Signální LED (žlutá)
USS-13		8595188124362		A1-A2, AC 230 V A1-A3, AC/DC 24 V	21 x 15 x 14 mm	Signální LED (bílá)
USS-14		8595188124898		A1-A2, AC 230 V A1-A3, AC/DC 24 V	21 x 15 x 14 mm	Signální LED BLIKACÍ (červená)
USS-15		8595188124379		A1-A2, AC 230 V A1-A3, AC/DC 24 V	21 x 15 x 14 mm	Signální LED (modrá)