

GLOBAL TRAC PULSE CONTROL

GLOBAL Trac Pulse control is a lighting track system that includes both normal input voltage and wires for transmitting the control signal to the lights.

This makes it possible to use smart control systems like DALI, KNX, LON, and EIB without central units. Various manufacturers provide control units, detectors and fixtures for the control systems which all share the same goal: to transmit the control signal to individual lights using the GLOBAL Trac Pulse control's wires and to create dynamic lighting.

Needs-based lighting

Dynamic lighting means that the lighting changes according to the situation and need. Lights can be turned on and off, brightened or dimmed flexibly as separate groups. This also saves energy, because lights are only turned on where necessary.



XTSC Surface

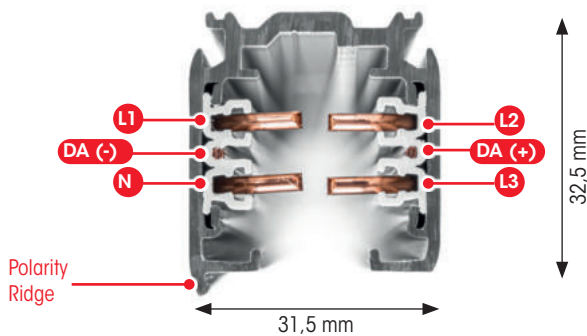

XTSCF Recessed

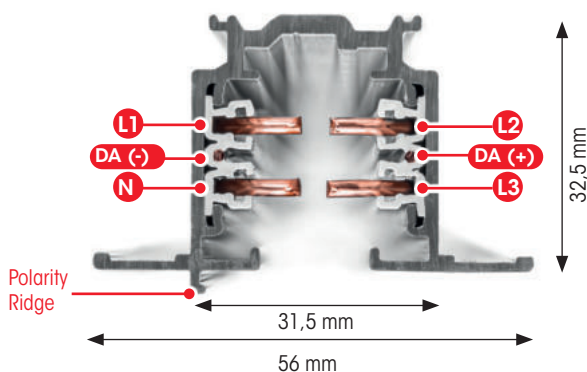

GLOBAL Trac Pulse control

Power Conductor Cross-Section: 4mm²
Control Conductor Cross-Section: 1,5mm²

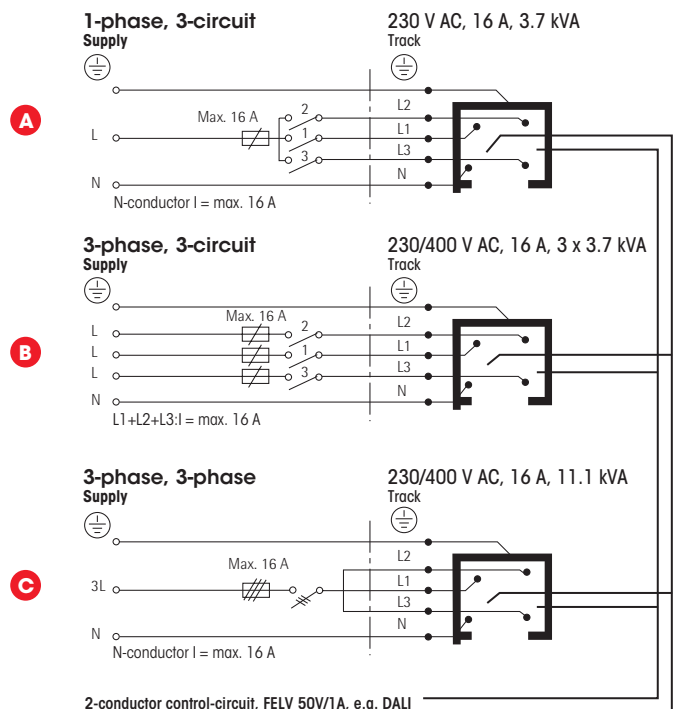

Control conductors, max 50V

GLOBAL TRAC PULSE CONTROL TRACKS

Available colours: -1 grey (RAL 7040), -2 black (RAL 9005), -3 white (RAL 9016).

Surface Mounted Tracks:

Purchase Code	Type	EAN code	Length (mm)	Colour	PCS/ Package
KKT30511	XTSC6100-1	6410014531423	1000	Grey	4/240
KKT30512	XTSC6100-2	6410014531430	1000	Black	4/240
KKT30513	XTSC6100-3	6410014531478	1000	White	4/240
KKT30521	XTSC6200-1	6410014531485	2000	Grey	4/240
KKT30522	XTSC6200-2	6410014531492	2000	Black	4/240
KKT30523	XTSC6200-3	6410014531508	2000	White	4/240
KKT30531	XTSC6300-1	6410014531515	3000	Grey	4/240
KKT30532	XTSC6300-2	6410014531522	3000	Black	4/240
KKT30533	XTSC6300-3	6410014531539	3000	White	4/240
KKT30541	XTSC6400-1	6410014531546	4000	Grey	4/240
KKT30542	XTSC6400-2	6410014531553	4000	Black	4/240
KKT30543	XTSC6400-3	6410014531560	4000	White	4/240

XTSC 6100-6400
Surface

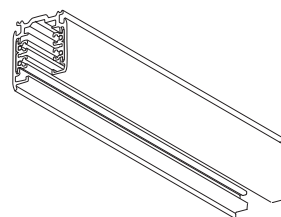

Recessed Tracks:

KKT305011	XTSCF6100-1	6410014531577	1000	Grey	6/180
KKT305012	XTSCF6100-2	6410014531584	1000	Black	6/180
KKT305013	XTSCF6100-3	6410014531591	1000	White	6/180
KKT305021	XTSCF6200-1	6410014531607	2000	Grey	6/180
KKT305022	XTSCF6200-2	6410014531614	2000	Black	6/180
KKT305023	XTSCF6200-3	6410014531621	2000	White	6/180
KKT305031	XTSCF6300-1	6410014531638	3000	Grey	6/180
KKT305032	XTSCF6300-2	6410014531645	3000	Black	6/180
KKT305033	XTSCF6300-3	6410014531683	3000	White	6/180

XTSCF 6100-6300
Recessed

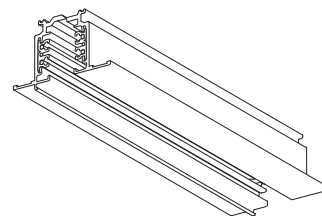

Recessed Track Accessories:

KKT304104	XTSNC610-1	6410014501341	Cover plate: XTSC611-XTSNC614	Grey	1/100
KKT304105	XTSNC610-2	6410014501358	Cover plate: XTSC611-XTSNC614	Black	1/100
KKT304106	XTSNC610-3	6410014501365	Cover plate: XTSC611-XTSNC614	White	1/100
KKT304304	XTSNC630-1	6410014501372	Cover plate: XTSNC634-XTSNC640	Grey	1/100
KKT304305	XTSNC630-2	6410014501389	Cover plate: XTSNC634-XTSNC640	Black	1/100
KKT304306	XTSNC630-3	6410014501396	Cover plate: XTSNC634-XTSNC640	White	1/100

Cover plates
XTSNC 610

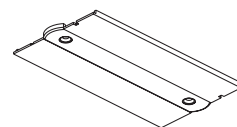

XTSNC 630

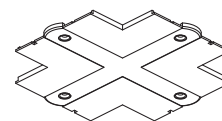

Bending tool for track power wires:

KKT30155	XTSV12	6410014500993		Blue	1/100
----------	--------	---------------	--	------	-------

Tool XTSV 12

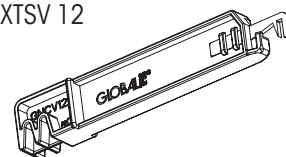

Cover strip for track opening:

KKT30152	XTSP11-2	6410014530990	Length 3000mm	Black	10/100
KKT30151	XTSP11-3	6410014530983	Length 3000mm	White	10/100

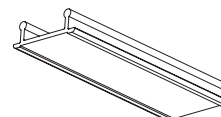

Cover strip
XTSP 11



GLOBAL TRAC PULSE CONTROL ACCESSORIES

All materials are halogen free and VO self-extinguishing.
Available colours: -1 grey (RAL 7040), -2 black (RAL 9005), -3 white (RAL 9016).

End Feeds:



Purchase Code	Type	EAN code	Polarity Ridge	Colour	PCS/ Package
KKT305111	XTSC611-1	6410014532376		Grey	1/50
KKT305112	XTSC611-2	6410014532383		Black	1/50
KKT305113	XTSC611-3	6410014532390		White	1/50
KKT305121	XTSC612-1	6410014532406		Grey	1/50
KKT305122	XTSC612-2	6410014532413		Black	1/50
KKT305123	XTSC612-3	6410014532420		White	1/50

End feed XTSC 611, 612

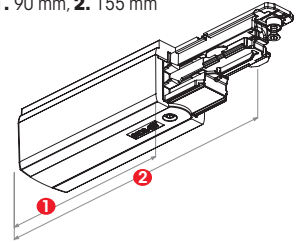
1. 90 mm, 2. 155 mm







Connectors with Power Supply Option:

KKT3053412	XTSNC634-1	6410014500917		Grey	1/25
KKT3053422	XTSNC634-2	6410014500924		Black	1/25
KKT3053432	XTSNC634-3	6410014500931		White	1/25
KKT3053512	XTSNC635-1	6410014500948		Grey	1/25
KKT3053522	XTSNC635-2	6410014500955		Black	1/25
KKT3053532	XTSNC635-3	6410014500962		White	1/25

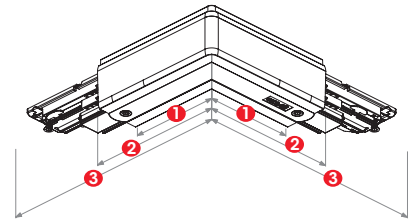
L-feed XTSNC 634, 635

1. 59 mm, 2. 91 mm 3. 156 mm



KKT3053612	XTSNC636-1	6410014500979		Grey	1/20
KKT3053622	XTSNC636-2	6410014500986		Black	1/20
KKT3053632	XTSNC636-3	6410014501006		White	1/20
KKT3053712	XTSNC637-1	6410014501013		Grey	1/20
KKT3053722	XTSNC637-2	6410014501020		Black	1/20
KKT3053732	XTSNC637-3	6410014501037		White	1/20
KKT3053912	XTSNC639-1	6410014501044		Grey	1/20
KKT3053922	XTSNC639-2	6410014501082		Black	1/20
KKT3053932	XTSNC639-3	6410014501099		White	1/20
KKT3054012	XTSNC640-1	6410014501105		Grey	1/20
KKT3054022	XTSNC640-2	6410014501112		Black	1/20
KKT3054032	XTSNC640-3	6410014501129		White	1/20

T-feed XTSNC 636, 637, 639, 640

1. 280 mm, 2. 150 mm 3. 59 mm
4. 124 mm 5. 91 mm
6. 156 mm

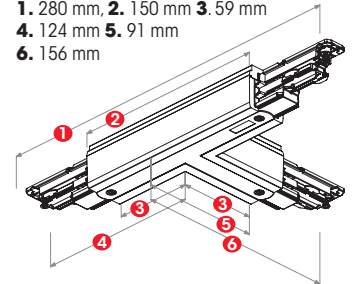

KKT3053812	XTSNC638-1	6410014501136		Grey	1/10
KKT3053822	XTSNC638-2	6410014501143		Black	1/10
KKT3053832	XTSNC638-3	6410014501181		White	1/10

X-feed XTSNC 638

1. 59 mm, 2. 150 mm 3. 280 mm

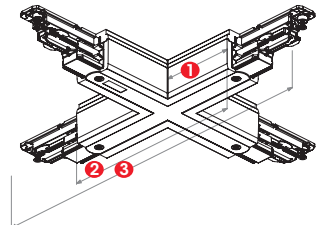

KKT3051412	XTSNC614-1	6410014501198	Grey	1/25
KKT3051422	XTSNC614-2	6410014501204	Black	1/25
KKT3051432	XTSNC614-3	6410014501211	White	1/25

Middle feed XTSNC 614

1. 150 mm, 2. 280 mm

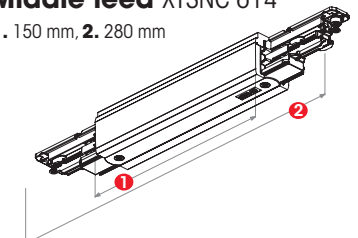

POLARITY IN TRAC PULSE

Use of L-, T- and X- Feed. Red line indicates polarity ridge

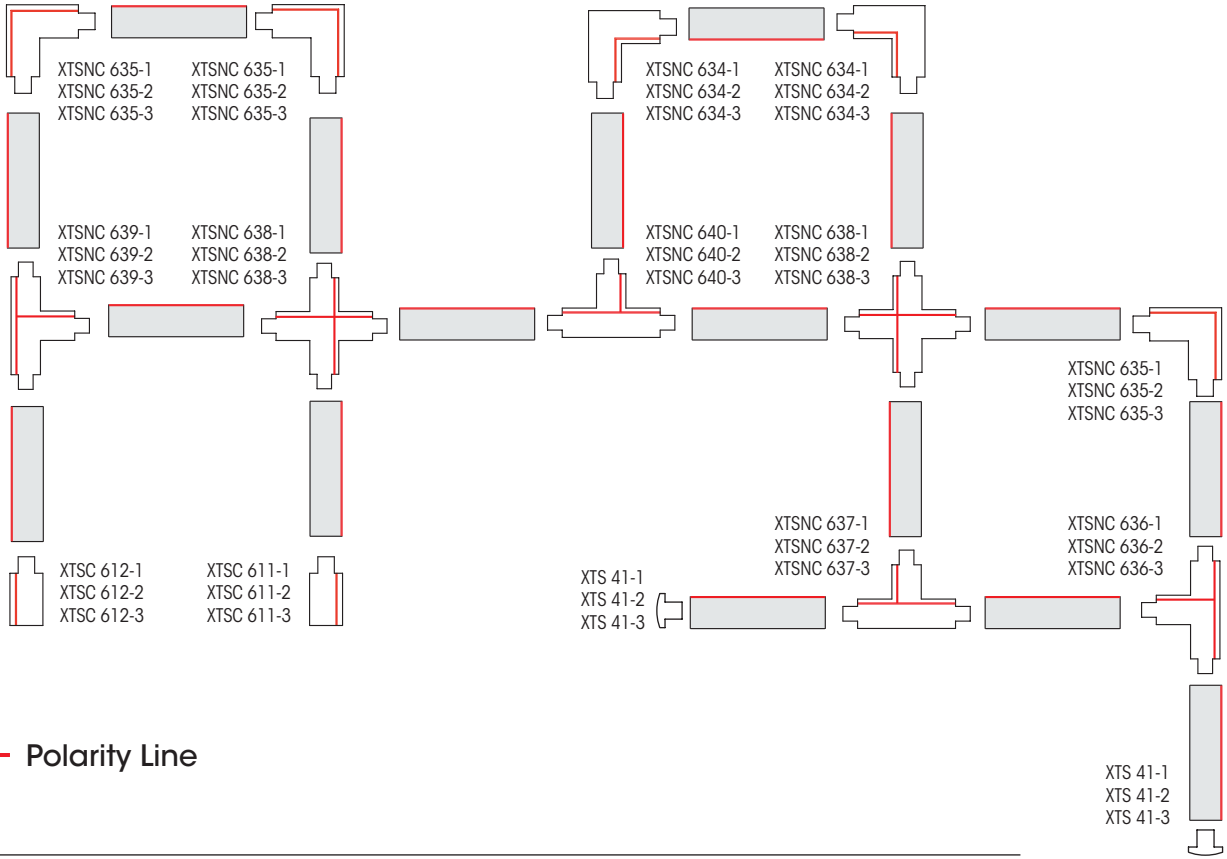

— Polarity Line

Connectors without option for power supply:

Purchase Code	Type	EAN code	Colour	PCS/ Package
KKT304211	XTSC621-1	6410014532109	Grey	1/100
KKT304212	XTSC621-2	6410014532116	Black	1/100
KKT304213	XTSC621-3	6410014532123	White	1/100

KKT305231	XTSC623-1	6410014532130	Grey	1/25
KKT305232	XTSC623-2	6410014532147	Black	1/25
KKT305233	XTSC623-3	6410014532154	White	1/25

End Cap:

KKT3012165	XTS41-1	6410014507329	Grey	1/100
KKT3012166	XTS41-2	6410014506414	Black	1/100
KKT3012172	XTS41-3	6410014507411	White	1/100

● *Flexibility - Enabling Energy Savings*

Straight connector

XTSC 621

1. 120 mm

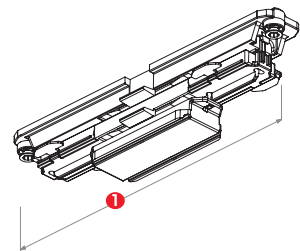

Flexible corner connector

XTSC 623

1. 82 mm, 2. 223 mm,
3. 353 mm

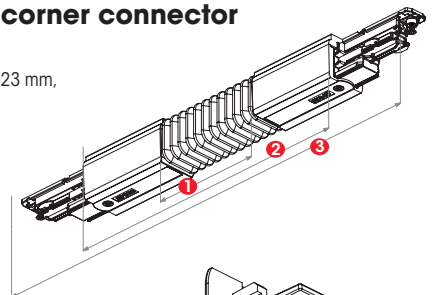

End cap XTS 41

1. 3 mm, 2. 21 mm

