

Datový list | Objednací číslo: 280-502/281-607

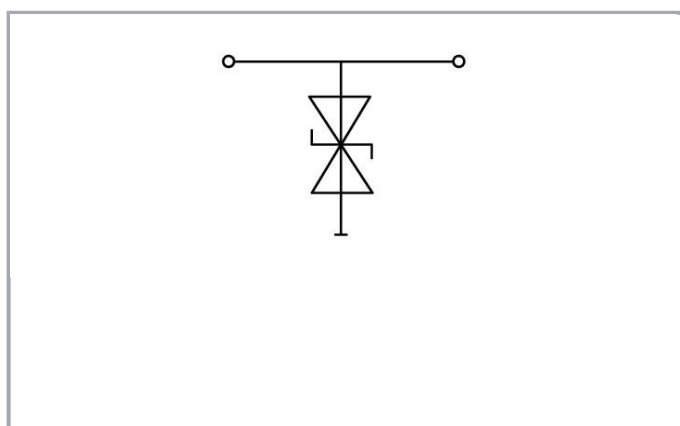

Svorka pro moduly; Dvoupatrová; S koncovou bočnicí a přímým připojením k DIN liště; S diodou BZW06-B TVS; AC 115 V; Na DIN lištu 35 × 15 a 35 × 7,5; 2,5 mm²; CAGE CLAMP®; 2,50 mm²; Šedá

www.wago.com/280-502/281-607

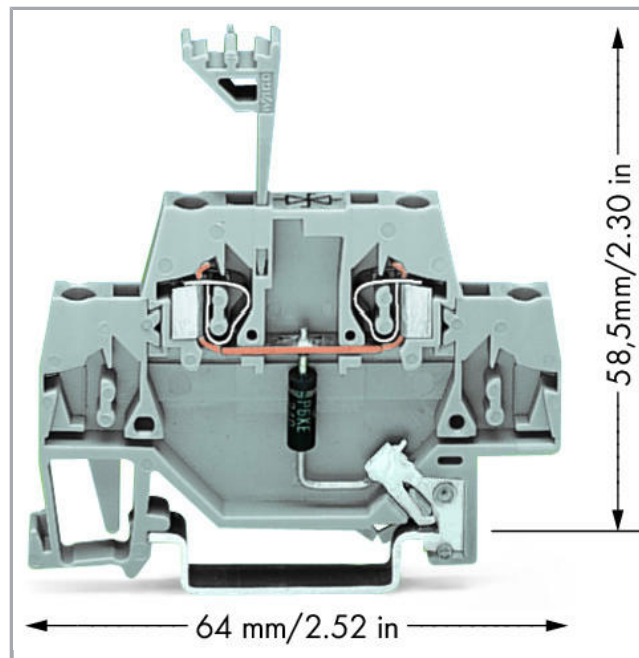
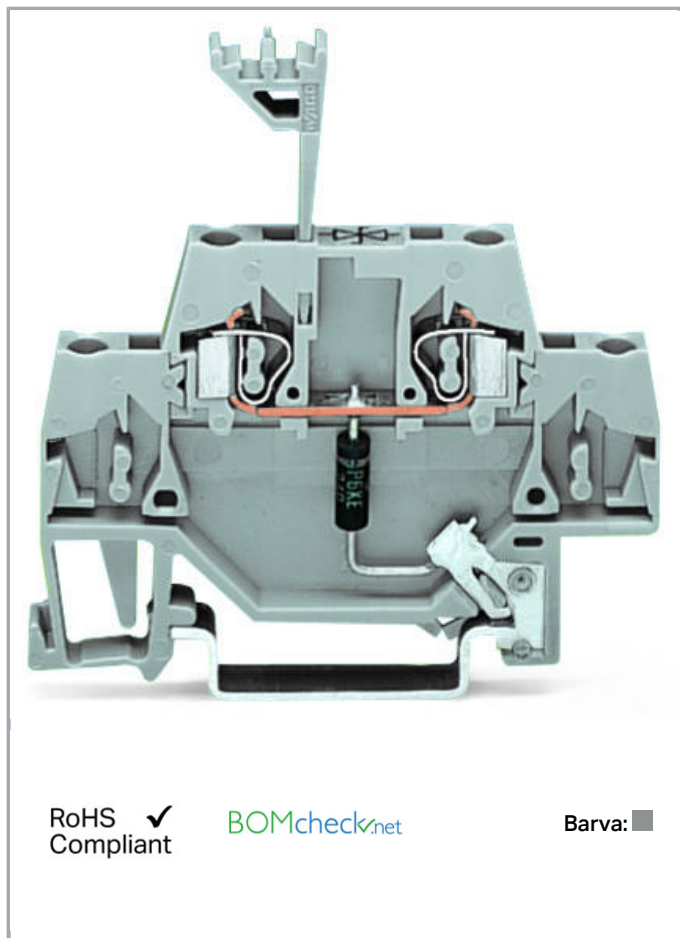

Popis položky

Short description:



Terminal blocks with surge suppression device and direct connection to the DIN-35 rail; these single-stage surge suppression devices are equipped either with 280 Series gas-filled surge arrester (coarse), varistor (medium) or suppressor diode (fine).

Features:

- Protect your system against overvoltage
- Slim, space-saving design
- Control operational costs by preventing expensive, unplanned downtime
- High operational reliability and system uptime

Data

Elektrické parametry

Nominal operating voltage	AC 115 V
Maximální nepřetržitě provozní napětí	AC 133 V
Jmenovitý proud (max.)	20 A
Nominal discharge current (10/1000 µs) per line	1,7 A
Voltage protection level (10/1000 µs)	≤ AC 384 V
Kapacita	≤ 360 pF

Údaje o připojení

Connections (number)	2
Připojovací technika	CAGE CLAMP®
Plný vodič	0,08 ... 2,5 mm ² / 28 ... 14 AWG
Jemně laněný vodič	0,08 ... 2,5 mm ² / 28 ... 14 AWG
Délka odizolování	8 ... 9 mm / 0.31 ... 0.35 palec

Geometrické údaje

Šířka	5 mm / 0.197 inch
Výška od horní hrany lišty DIN 35	58,5 mm / 2.303 inch
Hloubka	64 mm / 2.52 inch

Mechanické parametry

Provedení	With direct connection to DIN rail
Způsob montáže	Lišta DIN 35

Údaje o materiálu

barva	Šedá
Požární zatížení	0.172 MJ
Hmotnost	8.101

Obchodní údaje

Product Group	1 (Rail Mounted Terminal Blocks)
Druh balení	BOX
Country of origin	DE
GTIN	4050821860976
Customs Tariff No.	85369010000

Kompatibilní produkty



Jumper

	Obj. č.: 280-482 Hřebenový můstek; Izolováno; 2×; IN = IN svorky; Šedá	www.wago.com/280-482
	Obj. č.: 280-483 Hřebenový můstek; Izolováno; 3×; IN = IN svorky; Šedá	www.wago.com/280-483
	Obj. č.: 280-484 Hřebenový můstek; Izolováno; 4×; IN = IN svorky; Šedá	www.wago.com/280-484
	Obj. č.: 280-485 Hřebenový můstek; Izolováno; 5×; IN = IN svorky; Šedá	www.wago.com/280-485
	Obj. č.: 280-490 Hřebenový můstek; Izolováno; 10×; IN = IN svorky; Šedá	www.wago.com/280-490
	Obj. č.: 280-492 Hřebenový můstek ob svorku; Izolováno; 2×; IN = IN svorky; Šedá	www.wago.com/280-492



tools















	Obj. č.: 210-720 Ovládací nástroj; Břit: 3,5 × 0,5 mm; S částečně izolovanou rukojetí	www.wago.com/210-720
--	---	--















End plate















	Obj. č.: 280-340 Koncová bočnice a separátor; Tloušťka 2,5 mm; Šedá	www.wago.com/280-340
	Obj. č.: 280-341 Koncová bočnice a separátor; Tloušťka 2,5 mm; Oranžová	www.wago.com/280-341

Marking accessories

	Obj. č.: 2009-115 WMB Inline; Pro Smart Printer; Na cívce; Flexibilní, 5–5,2 mm; Bez potisku; Možnost naklapnutí; Bílá	www.wago.com/2009-115
	Obj. č.: 2009-115/000-002 WMB Inline; Pro Smart Printer; Na cívce; Flexibilní, 5–5,2 mm; Bez potisku; Možnost naklapnutí; Žlutá	www.wago.com/2009-115/000-002

	Obj. č.: 2009-115/000-006 WMB Inline; Pro Smart Printer; Na cívce; Flexibilní, 5–5,2 mm; Bez potisku; Možnost naklapnutí; Modrá	www.wago.com/2009-115/000-006
	Obj. č.: 2009-115/000-007 WMB Inline; Pro Smart Printer; Na cívce; Flexibilní, 5–5,2 mm; Bez potisku; Možnost naklapnutí; Šedá	www.wago.com/2009-115/000-007
	Obj. č.: 2009-115/000-012 WMB Inline; Pro Smart Printer; Na cívce; Flexibilní, 5–5,2 mm; Bez potisku; Možnost naklapnutí; Oranžová	www.wago.com/2009-115/000-012
	Obj. č.: 2009-115/000-017 WMB Inline; Pro Smart Printer; Na cívce; Flexibilní, 5–5,2 mm; Bez potisku; Možnost naklapnutí; Světle zelená	www.wago.com/2009-115/000-017
	Obj. č.: 2009-115/000-023 WMB Inline; Pro Smart Printer; Na cívce; Flexibilní, 5–5,2 mm; Bez potisku; Možnost naklapnutí; Zelená	www.wago.com/2009-115/000-023
	Obj. č.: 2009-115/000-024 WMB Inline; Pro Smart Printer; Na cívce; Flexibilní, 5–5,2 mm; Bez potisku; Možnost naklapnutí; Fialová	www.wago.com/2009-115/000-024
	Obj. č.: 793-501 Popisovací karta WMB; Jako karta; Neflexibilní; Bez potisku; Možnost naklapnutí; Bílá	www.wago.com/793-501
	Obj. č.: 793-501/000-002 Popisovací karta WMB; Jako karta; Neflexibilní; Bez potisku; Možnost naklapnutí; Bílá	www.wago.com/793-501/000-002
	Obj. č.: 793-501/000-005 Popisovací karta WMB; Jako karta; Neflexibilní; Bez potisku; Možnost naklapnutí; Červená	www.wago.com/793-501/000-005
	Obj. č.: 793-501/000-006 Popisovací karta WMB; Jako karta; Neflexibilní; Bez potisku; Možnost naklapnutí; Modrá	www.wago.com/793-501/000-006
	Obj. č.: 793-501/000-007 Popisovací karta WMB; Jako karta; Neflexibilní; Bez potisku; Možnost naklapnutí; Šedá	www.wago.com/793-501/000-007
	Obj. č.: 793-501/000-012 Popisovací karta WMB; Jako karta; Neflexibilní; Bez potisku; Možnost naklapnutí; Oranžová	www.wago.com/793-501/000-012
	Obj. č.: 793-501/000-017 Popisovací karta WMB; Jako karta; Neflexibilní; Bez potisku; Možnost naklapnutí; Světle zelená	www.wago.com/793-501/000-017
	Obj. č.: 793-501/000-023 Popisovací karta WMB; Jako karta; Neflexibilní; Bez potisku; Možnost naklapnutí; Zelená	www.wago.com/793-501/000-023
	Obj. č.: 793-501/000-024 Popisovací karta WMB; Jako karta; Neflexibilní; Bez potisku; Možnost naklapnutí; Fialová	www.wago.com/793-501/000-024

	Obj. č.: 793-502 Popisovací karta WMB; Jako karta; S potiskem; 1–10 (10×); Neflexibilní; Potisk vodorovný; Možnost naklapnutí; Bílá	www.wago.com/793-502
	Obj. č.: 793-502/000-002 Popisovací karta WMB; Jako karta; S potiskem; 1–10 (10×); Neflexibilní; Potisk vodorovný; Možnost naklapnutí; Žlutá	www.wago.com/793-502/000-002
	Obj. č.: 793-502/000-005 Popisovací karta WMB; Jako karta; S potiskem; 1–10 (10×); Neflexibilní; Potisk vodorovný; Možnost naklapnutí; Červená	www.wago.com/793-502/000-005
	Obj. č.: 793-502/000-006 Popisovací karta WMB; Jako karta; S potiskem; 1–10 (10×); Neflexibilní; Potisk vodorovný; Možnost naklapnutí; Modrá	www.wago.com/793-502/000-006
	Obj. č.: 793-502/000-007 Popisovací karta WMB; Jako karta; S potiskem; 1–10 (10×); Neflexibilní; Potisk vodorovný; Možnost naklapnutí; Šedá	www.wago.com/793-502/000-007
	Obj. č.: 793-502/000-012 Popisovací karta WMB; Jako karta; S potiskem; 1–10 (10×); Neflexibilní; Potisk vodorovný; Možnost naklapnutí; Oranžová	www.wago.com/793-502/000-012
	Obj. č.: 793-502/000-017 Popisovací karta WMB; Jako karta; S potiskem; 1–10 (10×); Neflexibilní; Potisk vodorovný; Možnost naklapnutí; Světle zelená	www.wago.com/793-502/000-017
	Obj. č.: 793-502/000-023 Popisovací karta WMB; Jako karta; S potiskem; 1–10 (10×); Neflexibilní; Potisk vodorovný; Možnost naklapnutí; Zelená	www.wago.com/793-502/000-023
	Obj. č.: 793-502/000-024 Popisovací karta WMB; Jako karta; S potiskem; 1–10 (10×); Neflexibilní; Potisk vodorovný; Možnost naklapnutí; Fialová	www.wago.com/793-502/000-024
	Obj. č.: 793-503 Popisovací karta WMB; Jako karta; S potiskem; 11–20 (10×); Neflexibilní; Potisk vodorovný; Možnost naklapnutí; Bílá	www.wago.com/793-503
	Obj. č.: 793-503/000-002 Popisovací karta WMB; Jako karta; S potiskem; 11–20 (10×); Neflexibilní; Potisk vodorovný; Možnost naklapnutí; Žlutá	www.wago.com/793-503/000-002
	Obj. č.: 793-503/000-005 Popisovací karta WMB; Jako karta; S potiskem; 11–20 (10×); Neflexibilní; Potisk vodorovný; Možnost naklapnutí; Červená	www.wago.com/793-503/000-005
	Obj. č.: 793-503/000-006 Popisovací karta WMB; Jako karta; S potiskem; 11–20 (10×); Neflexibilní; Potisk vodorovný; Možnost naklapnutí; Modrá	www.wago.com/793-503/000-006
	Obj. č.: 793-503/000-007 Popisovací karta WMB; Jako karta; S potiskem; 11–20 (10×); Neflexibilní; Potisk vodorovný; Možnost naklapnutí; Šedá	www.wago.com/793-503/000-007
	Obj. č.: 793-503/000-012 Popisovací karta WMB; Jako karta; S potiskem; 11–20 (10×); Neflexibilní; Potisk vodorovný; Možnost naklapnutí; Oranžová	www.wago.com/793-503/000-012

	Obj. č.: 793-503/000-017 Popisovací karta WMB; Jako karta; S potiskem; 11–20 (10×); Neflexibilní; Potisk vodorovný; Možnost naklapnutí; Světle zelená	www.wago.com/793-503/000-017
	Obj. č.: 793-503/000-023 Popisovací karta WMB; Jako karta; S potiskem; 11–20 (10×); Neflexibilní; Potisk vodorovný; Možnost naklapnutí; Zelená	www.wago.com/793-503/000-023
	Obj. č.: 793-503/000-024 Popisovací karta WMB; Jako karta; S potiskem; 11–20 (10×); Neflexibilní; Potisk vodorovný; Možnost naklapnutí; Fialová	www.wago.com/793-503/000-024
	Obj. č.: 793-504 Popisovací karta WMB; Jako karta; S potiskem; 21–30 (10×); Neflexibilní; Potisk vodorovný; Možnost naklapnutí; Bílá	www.wago.com/793-504
	Obj. č.: 793-504/000-002 Popisovací karta WMB; Jako karta; S potiskem; 21–30 (10×); Neflexibilní; Potisk vodorovný; Možnost naklapnutí; Žlutá	www.wago.com/793-504/000-002
	Obj. č.: 793-504/000-005 Popisovací karta WMB; Jako karta; S potiskem; 21–30 (10×); Neflexibilní; Potisk vodorovný; Možnost naklapnutí; Červená	www.wago.com/793-504/000-005
	Obj. č.: 793-504/000-006 Popisovací karta WMB; Jako karta; S potiskem; 21–30 (10×); Neflexibilní; Potisk vodorovný; Možnost naklapnutí; Modrá	www.wago.com/793-504/000-006
	Obj. č.: 793-504/000-012 Popisovací karta WMB; Jako karta; S potiskem; 21–30 (10×); Neflexibilní; Potisk vodorovný; Možnost naklapnutí; Oranžová	www.wago.com/793-504/000-012
	Obj. č.: 793-504/000-017 Popisovací karta WMB; Jako karta; S potiskem; 21–30 (10×); Neflexibilní; Potisk vodorovný; Možnost naklapnutí; Světle zelená	www.wago.com/793-504/000-017
	Obj. č.: 793-504/000-023 Popisovací karta WMB; Jako karta; S potiskem; 21–30 (10×); Neflexibilní; Potisk vodorovný; Možnost naklapnutí; Zelená	www.wago.com/793-504/000-023
	Obj. č.: 793-505 Popisovací karta WMB; Jako karta; S potiskem; 31–40 (10×); Neflexibilní; Potisk vodorovný; Možnost naklapnutí; Bílá	www.wago.com/793-505
	Obj. č.: 793-505/000-005 Popisovací karta WMB; Jako karta; S potiskem; 31–40 (10×); Neflexibilní; Potisk vodorovný; Možnost naklapnutí; Červená	www.wago.com/793-505/000-005
	Obj. č.: 793-505/000-006 Popisovací karta WMB; Jako karta; S potiskem; 31–40 (10×); Neflexibilní; Potisk vodorovný; Možnost naklapnutí; Modrá	www.wago.com/793-505/000-006
	Obj. č.: 793-505/000-007 Popisovací karta WMB; Jako karta; S potiskem; 31–40 (10×); Neflexibilní; Potisk vodorovný; Možnost naklapnutí; Šedá	www.wago.com/793-505/000-007
	Obj. č.: 793-505/000-012 Popisovací karta WMB; Jako karta; S potiskem; 31–40 (10×); Neflexibilní; Potisk vodorovný; Možnost naklapnutí; Oranžová	www.wago.com/793-505/000-012

	Obj. č.: 793-506 Popisovací karta WMB; Jako karta; S potiskem; 41–50 (10×); Neflexibilní; Potisk vodorovný; Možnost naklapnutí; Bílá	www.wago.com/793-506
	Obj. č.: 793-506/000-005 Popisovací karta WMB; Jako karta; S potiskem; 41–50 (10×); Neflexibilní; Potisk vodorovný; Možnost naklapnutí; Červená	www.wago.com/793-506/000-005
	Obj. č.: 793-506/000-006 Popisovací karta WMB; Jako karta; S potiskem; 41–50 (10×); Neflexibilní; Potisk vodorovný; Možnost naklapnutí; Modrá	www.wago.com/793-506/000-006
	Obj. č.: 793-506/000-012 Popisovací karta WMB; Jako karta; S potiskem; 41–50 (10×); Neflexibilní; Potisk vodorovný; Možnost naklapnutí; Oranžová	www.wago.com/793-506/000-012
	Obj. č.: 793-506/000-017 Popisovací karta WMB; Jako karta; S potiskem; 41–50 (10×); Neflexibilní; Potisk vodorovný; Možnost naklapnutí; Světle zelená	www.wago.com/793-506/000-017
Insulation stop		
	Obj. č.: 280-470 Izolační zarážka; 0,08–0,2 mm ² „e“ (0,14 mm ² „f“); 5 ks/pás; Bílá	www.wago.com/280-470
	Obj. č.: 280-471 Izolační zarážka; 0,25–0,5 mm ² ; 5 ks/pás; Světle šedá	www.wago.com/280-471
	Obj. č.: 280-472 Izolační zarážka; 0,75–1 mm ² ; 5 ks/pás	www.wago.com/280-472

Ke stažení

Documentation

Additional Information

Disposal; Electrical and electronic equipment, Packaging	V 1.0.0	pdf 265,8 kB	Stáhnout
--	---------	-----------------	----------

CAD/CAE-Data

CAD data

2D/3D Models 280-502/281-607	URL	Stáhnout
------------------------------	-----	----------

CAE data

EPLAN Data Portal 280-502/281-607	Stáhnout
-----------------------------------	----------

WSCAD Universe 280-502/281-607	Stáhnout
--------------------------------	----------



Handling Instructions

Změny vyhrazeny.

WAGO Elektro spol. sr. o.
Rozvodova 1116/36
143 00 Praha 12 - Modřany
Tel.: +420 261 090 143
Email: info.cz@wago.com, wago-cz@wago.com

Máte otázky ohledně našich produktů?
Kdykoli nám zavolejte na číslo +420 261 090 143.