

Datový list | Objednací číslo: 280-502/281-605

Svorka pro moduly; Dvoupatrová; S koncovou bočnicí a přímým připojením k DIN liště; S diodou BZW06-B TVS; DC 110 V; Na DIN lištu 35 × 15 a 35 × 7,5; 2,5 mm<sup>2</sup>; CAGE CLAMP®; 2,50 mm<sup>2</sup>; Šedá

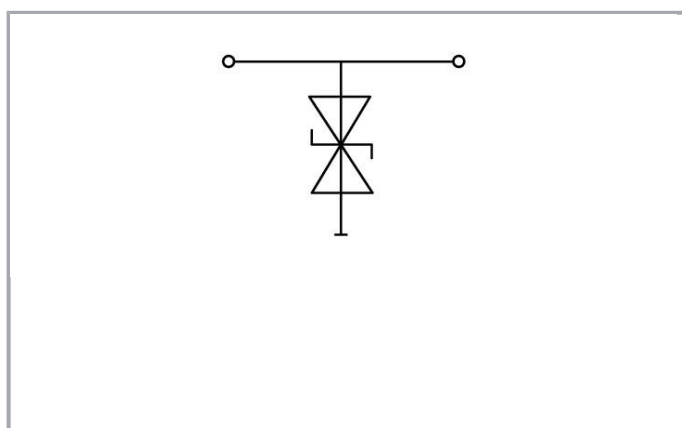

[www.wago.com/280-502/281-605](http://www.wago.com/280-502/281-605)

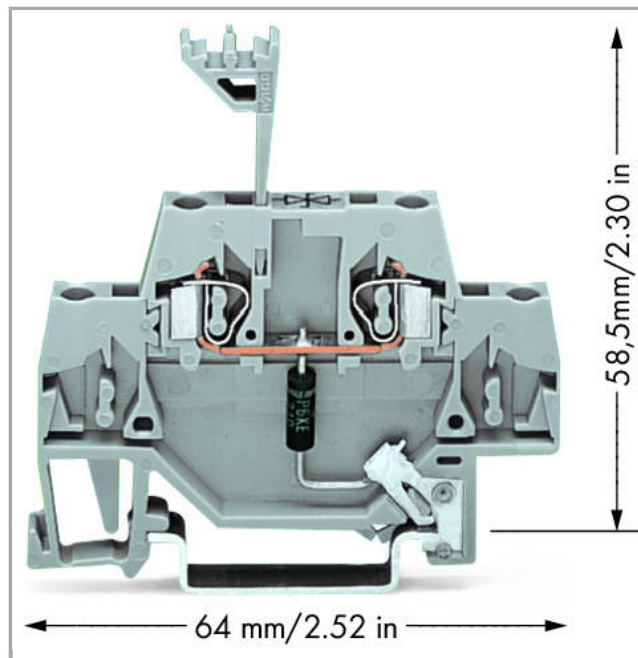
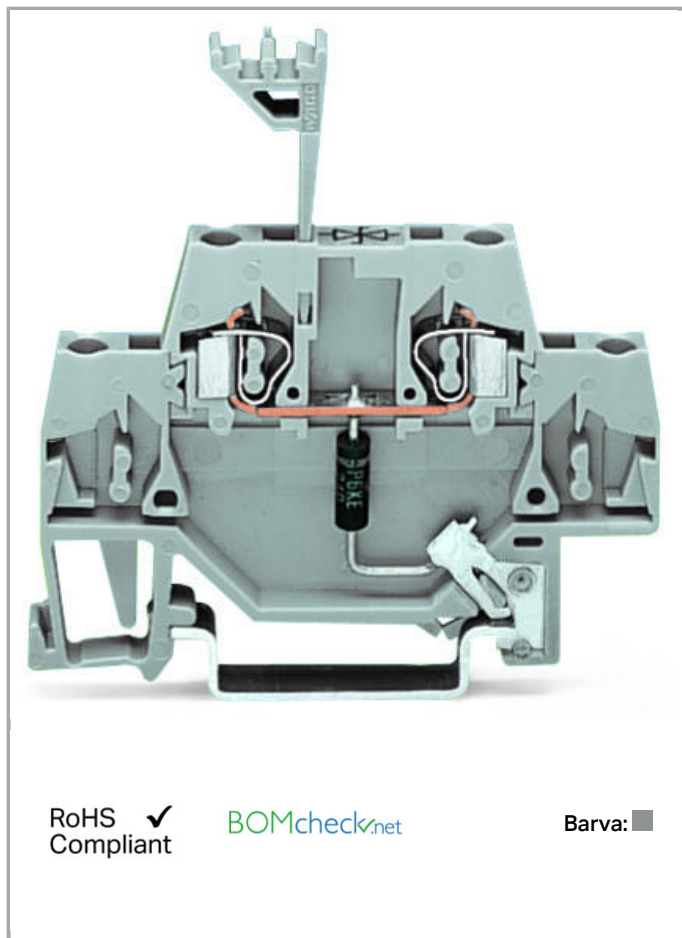

Popis položky

Short description:



Terminal blocks with surge suppression device and direct connection to the DIN-35 rail; these single-stage surge suppression devices are equipped either with 280 Series gas-filled surge arrester (coarse), varistor (medium) or suppressor diode (fine).

#### Features:

- Protect your system against overvoltage
- Slim, space-saving design
- Control operational costs by preventing expensive, unplanned downtime
- High operational reliability and system uptime

#### Data

##### Elektrické parametry

Nominal operating voltage	DC 110 V
Maximální nepřetržitě provozní napětí	DC 136 V
Jmenovitý proud (max.)	20 A
Nominal discharge current (10/1000 µs) per line	2,7 A
Voltage protection level (10/1000 µs)	≤ DC 219 V
Response time line/line	≤
Kapacita	≤ 400 pF

##### Údaje o připojení

Connections (number)	2
Připojovací technika	CAGE CLAMP®
Plný vodič	0,08 ... 2,5 mm <sup>2</sup> / 28 ... 14 AWG
Jemně laněný vodič	0,08 ... 2,5 mm <sup>2</sup> / 28 ... 14 AWG
Délka odizolování	8 ... 9 mm / 0.31 ... 0.35 palec

##### Geometrické údaje

Šířka	5 mm / 0.197 inch
Výška od horní hrany lišty DIN 35	58,5 mm / 2.303 inch
Hloubka	64 mm / 2.52 inch

##### Mechanické parametry

Provedení	With direct connection to DIN rail
Způsob montáže	Lišta DIN 35

##### Údaje o materiálu

barva	Šedá
Hmotnost	8.101

## Obchodní údaje

Product Group	1 (Rail Mounted Terminal Blocks)
Druh balení	BOX
Country of origin	DE
GTIN	4045454585242
Customs Tariff No.	85369010000

## Kompatibilní produkty



### Jumper

	<b>Obj. č.: 280-482</b> Hřebenový můstek; Izolováno; 2x; IN = IN svorky; Šedá	<a href="http://www.wago.com/280-482">www.wago.com/280-482</a>
	<b>Obj. č.: 280-483</b> Hřebenový můstek; Izolováno; 3x; IN = IN svorky; Šedá	<a href="http://www.wago.com/280-483">www.wago.com/280-483</a>
	<b>Obj. č.: 280-484</b> Hřebenový můstek; Izolováno; 4x; IN = IN svorky; Šedá	<a href="http://www.wago.com/280-484">www.wago.com/280-484</a>
	<b>Obj. č.: 280-485</b> Hřebenový můstek; Izolováno; 5x; IN = IN svorky; Šedá	<a href="http://www.wago.com/280-485">www.wago.com/280-485</a>
	<b>Obj. č.: 280-490</b> Hřebenový můstek; Izolováno; 10x; IN = IN svorky; Šedá	<a href="http://www.wago.com/280-490">www.wago.com/280-490</a>
	<b>Obj. č.: 280-492</b> Hřebenový můstek ob svorku; Izolováno; 2x; IN = IN svorky; Šedá	<a href="http://www.wago.com/280-492">www.wago.com/280-492</a>



### tools















	<b>Obj. č.: 210-720</b> Ovládací nástroj; Břit: 3,5 × 0,5 mm; S částečně izolovanou rukojetí	<a href="http://www.wago.com/210-720">www.wago.com/210-720</a>
--	---	--















### End plate















	<b>Obj. č.: 280-340</b> Koncová bočnice a separátor; Tloušťka 2,5 mm; Šedá	<a href="http://www.wago.com/280-340">www.wago.com/280-340</a>
	<b>Obj. č.: 280-341</b> Koncová bočnice a separátor; Tloušťka 2,5 mm; Oranžová	<a href="http://www.wago.com/280-341">www.wago.com/280-341</a>

### Marking accessories

	<b>Obj. č.: 2009-115</b> WMB Inline; Pro Smart Printer; Na cívce; Flexibilní, 5–5,2 mm; Bez potisku; Možnost naklapnutí; Bílá	<a href="http://www.wago.com/2009-115">www.wago.com/2009-115</a>
	<b>Obj. č.: 2009-115/000-002</b> WMB Inline; Pro Smart Printer; Na cívce; Flexibilní, 5–5,2 mm; Bez potisku; Možnost naklapnutí; Žlutá	<a href="http://www.wago.com/2009-115/000-002">www.wago.com/2009-115/000-002</a>

	<b>Obj. č.: 2009-115/000-006</b> WMB Inline; Pro Smart Printer; Na cívce; Flexibilní, 5–5,2 mm; Bez potisku; Možnost naklapnutí; Modrá	<a href="http://www.wago.com/2009-115/000-006">www.wago.com/2009-115/000-006</a>
	<b>Obj. č.: 2009-115/000-007</b> WMB Inline; Pro Smart Printer; Na cívce; Flexibilní, 5–5,2 mm; Bez potisku; Možnost naklapnutí; Šedá	<a href="http://www.wago.com/2009-115/000-007">www.wago.com/2009-115/000-007</a>
	<b>Obj. č.: 2009-115/000-012</b> WMB Inline; Pro Smart Printer; Na cívce; Flexibilní, 5–5,2 mm; Bez potisku; Možnost naklapnutí; Oranžová	<a href="http://www.wago.com/2009-115/000-012">www.wago.com/2009-115/000-012</a>
	<b>Obj. č.: 2009-115/000-017</b> WMB Inline; Pro Smart Printer; Na cívce; Flexibilní, 5–5,2 mm; Bez potisku; Možnost naklapnutí; Světle zelená	<a href="http://www.wago.com/2009-115/000-017">www.wago.com/2009-115/000-017</a>
	<b>Obj. č.: 2009-115/000-023</b> WMB Inline; Pro Smart Printer; Na cívce; Flexibilní, 5–5,2 mm; Bez potisku; Možnost naklapnutí; Zelená	<a href="http://www.wago.com/2009-115/000-023">www.wago.com/2009-115/000-023</a>
	<b>Obj. č.: 2009-115/000-024</b> WMB Inline; Pro Smart Printer; Na cívce; Flexibilní, 5–5,2 mm; Bez potisku; Možnost naklapnutí; Fialová	<a href="http://www.wago.com/2009-115/000-024">www.wago.com/2009-115/000-024</a>
	<b>Obj. č.: 793-501</b> Popisovací karta WMB; Jako karta; Neflexibilní; Bez potisku; Možnost naklapnutí; Bílá	<a href="http://www.wago.com/793-501">www.wago.com/793-501</a>
	<b>Obj. č.: 793-501/000-002</b> Popisovací karta WMB; Jako karta; Neflexibilní; Bez potisku; Možnost naklapnutí; Bílá	<a href="http://www.wago.com/793-501/000-002">www.wago.com/793-501/000-002</a>
	<b>Obj. č.: 793-501/000-005</b> Popisovací karta WMB; Jako karta; Neflexibilní; Bez potisku; Možnost naklapnutí; Červená	<a href="http://www.wago.com/793-501/000-005">www.wago.com/793-501/000-005</a>
	<b>Obj. č.: 793-501/000-006</b> Popisovací karta WMB; Jako karta; Neflexibilní; Bez potisku; Možnost naklapnutí; Modrá	<a href="http://www.wago.com/793-501/000-006">www.wago.com/793-501/000-006</a>
	<b>Obj. č.: 793-501/000-007</b> Popisovací karta WMB; Jako karta; Neflexibilní; Bez potisku; Možnost naklapnutí; Šedá	<a href="http://www.wago.com/793-501/000-007">www.wago.com/793-501/000-007</a>
	<b>Obj. č.: 793-501/000-012</b> Popisovací karta WMB; Jako karta; Neflexibilní; Bez potisku; Možnost naklapnutí; Oranžová	<a href="http://www.wago.com/793-501/000-012">www.wago.com/793-501/000-012</a>
	<b>Obj. č.: 793-501/000-017</b> Popisovací karta WMB; Jako karta; Neflexibilní; Bez potisku; Možnost naklapnutí; Světle zelená	<a href="http://www.wago.com/793-501/000-017">www.wago.com/793-501/000-017</a>
	<b>Obj. č.: 793-501/000-023</b> Popisovací karta WMB; Jako karta; Neflexibilní; Bez potisku; Možnost naklapnutí; Zelená	<a href="http://www.wago.com/793-501/000-023">www.wago.com/793-501/000-023</a>
	<b>Obj. č.: 793-501/000-024</b> Popisovací karta WMB; Jako karta; Neflexibilní; Bez potisku; Možnost naklapnutí; Fialová	<a href="http://www.wago.com/793-501/000-024">www.wago.com/793-501/000-024</a>

	<b>Obj. č.: 793-502</b> Popisovací karta WMB; Jako karta; S potiskem; 1–10 (10×); Neflexibilní; Potisk vodorovný; Možnost naklapnutí; Bílá	<a href="http://www.wago.com/793-502">www.wago.com/793-502</a>
	<b>Obj. č.: 793-502/000-002</b> Popisovací karta WMB; Jako karta; S potiskem; 1–10 (10×); Neflexibilní; Potisk vodorovný; Možnost naklapnutí; Žlutá	<a href="http://www.wago.com/793-502/000-002">www.wago.com/793-502/000-002</a>
	<b>Obj. č.: 793-502/000-005</b> Popisovací karta WMB; Jako karta; S potiskem; 1–10 (10×); Neflexibilní; Potisk vodorovný; Možnost naklapnutí; Červená	<a href="http://www.wago.com/793-502/000-005">www.wago.com/793-502/000-005</a>
	<b>Obj. č.: 793-502/000-006</b> Popisovací karta WMB; Jako karta; S potiskem; 1–10 (10×); Neflexibilní; Potisk vodorovný; Možnost naklapnutí; Modrá	<a href="http://www.wago.com/793-502/000-006">www.wago.com/793-502/000-006</a>
	<b>Obj. č.: 793-502/000-007</b> Popisovací karta WMB; Jako karta; S potiskem; 1–10 (10×); Neflexibilní; Potisk vodorovný; Možnost naklapnutí; Šedá	<a href="http://www.wago.com/793-502/000-007">www.wago.com/793-502/000-007</a>
	<b>Obj. č.: 793-502/000-012</b> Popisovací karta WMB; Jako karta; S potiskem; 1–10 (10×); Neflexibilní; Potisk vodorovný; Možnost naklapnutí; Oranžová	<a href="http://www.wago.com/793-502/000-012">www.wago.com/793-502/000-012</a>
	<b>Obj. č.: 793-502/000-017</b> Popisovací karta WMB; Jako karta; S potiskem; 1–10 (10×); Neflexibilní; Potisk vodorovný; Možnost naklapnutí; Světle zelená	<a href="http://www.wago.com/793-502/000-017">www.wago.com/793-502/000-017</a>
	<b>Obj. č.: 793-502/000-023</b> Popisovací karta WMB; Jako karta; S potiskem; 1–10 (10×); Neflexibilní; Potisk vodorovný; Možnost naklapnutí; Zelená	<a href="http://www.wago.com/793-502/000-023">www.wago.com/793-502/000-023</a>
	<b>Obj. č.: 793-502/000-024</b> Popisovací karta WMB; Jako karta; S potiskem; 1–10 (10×); Neflexibilní; Potisk vodorovný; Možnost naklapnutí; Fialová	<a href="http://www.wago.com/793-502/000-024">www.wago.com/793-502/000-024</a>
	<b>Obj. č.: 793-503</b> Popisovací karta WMB; Jako karta; S potiskem; 11–20 (10×); Neflexibilní; Potisk vodorovný; Možnost naklapnutí; Bílá	<a href="http://www.wago.com/793-503">www.wago.com/793-503</a>
	<b>Obj. č.: 793-503/000-002</b> Popisovací karta WMB; Jako karta; S potiskem; 11–20 (10×); Neflexibilní; Potisk vodorovný; Možnost naklapnutí; Žlutá	<a href="http://www.wago.com/793-503/000-002">www.wago.com/793-503/000-002</a>
	<b>Obj. č.: 793-503/000-005</b> Popisovací karta WMB; Jako karta; S potiskem; 11–20 (10×); Neflexibilní; Potisk vodorovný; Možnost naklapnutí; Červená	<a href="http://www.wago.com/793-503/000-005">www.wago.com/793-503/000-005</a>
	<b>Obj. č.: 793-503/000-006</b> Popisovací karta WMB; Jako karta; S potiskem; 11–20 (10×); Neflexibilní; Potisk vodorovný; Možnost naklapnutí; Modrá	<a href="http://www.wago.com/793-503/000-006">www.wago.com/793-503/000-006</a>
	<b>Obj. č.: 793-503/000-007</b> Popisovací karta WMB; Jako karta; S potiskem; 11–20 (10×); Neflexibilní; Potisk vodorovný; Možnost naklapnutí; Šedá	<a href="http://www.wago.com/793-503/000-007">www.wago.com/793-503/000-007</a>
	<b>Obj. č.: 793-503/000-012</b> Popisovací karta WMB; Jako karta; S potiskem; 11–20 (10×); Neflexibilní; Potisk vodorovný; Možnost naklapnutí; Oranžová	<a href="http://www.wago.com/793-503/000-012">www.wago.com/793-503/000-012</a>

	<b>Obj. č.: 793-503/000-017</b> Popisovací karta WMB; Jako karta; S potiskem; 11–20 (10×); Neflexibilní; Potisk vodorovný; Možnost naklapnutí; Světle zelená	<a href="http://www.wago.com/793-503/000-017">www.wago.com/793-503/000-017</a>
	<b>Obj. č.: 793-503/000-023</b> Popisovací karta WMB; Jako karta; S potiskem; 11–20 (10×); Neflexibilní; Potisk vodorovný; Možnost naklapnutí; Zelená	<a href="http://www.wago.com/793-503/000-023">www.wago.com/793-503/000-023</a>
	<b>Obj. č.: 793-503/000-024</b> Popisovací karta WMB; Jako karta; S potiskem; 11–20 (10×); Neflexibilní; Potisk vodorovný; Možnost naklapnutí; Fialová	<a href="http://www.wago.com/793-503/000-024">www.wago.com/793-503/000-024</a>
	<b>Obj. č.: 793-504</b> Popisovací karta WMB; Jako karta; S potiskem; 21–30 (10×); Neflexibilní; Potisk vodorovný; Možnost naklapnutí; Bílá	<a href="http://www.wago.com/793-504">www.wago.com/793-504</a>
	<b>Obj. č.: 793-504/000-002</b> Popisovací karta WMB; Jako karta; S potiskem; 21–30 (10×); Neflexibilní; Potisk vodorovný; Možnost naklapnutí; Žlutá	<a href="http://www.wago.com/793-504/000-002">www.wago.com/793-504/000-002</a>
	<b>Obj. č.: 793-504/000-005</b> Popisovací karta WMB; Jako karta; S potiskem; 21–30 (10×); Neflexibilní; Potisk vodorovný; Možnost naklapnutí; Červená	<a href="http://www.wago.com/793-504/000-005">www.wago.com/793-504/000-005</a>
	<b>Obj. č.: 793-504/000-006</b> Popisovací karta WMB; Jako karta; S potiskem; 21–30 (10×); Neflexibilní; Potisk vodorovný; Možnost naklapnutí; Modrá	<a href="http://www.wago.com/793-504/000-006">www.wago.com/793-504/000-006</a>
	<b>Obj. č.: 793-504/000-012</b> Popisovací karta WMB; Jako karta; S potiskem; 21–30 (10×); Neflexibilní; Potisk vodorovný; Možnost naklapnutí; Oranžová	<a href="http://www.wago.com/793-504/000-012">www.wago.com/793-504/000-012</a>
	<b>Obj. č.: 793-504/000-017</b> Popisovací karta WMB; Jako karta; S potiskem; 21–30 (10×); Neflexibilní; Potisk vodorovný; Možnost naklapnutí; Světle zelená	<a href="http://www.wago.com/793-504/000-017">www.wago.com/793-504/000-017</a>
	<b>Obj. č.: 793-504/000-023</b> Popisovací karta WMB; Jako karta; S potiskem; 21–30 (10×); Neflexibilní; Potisk vodorovný; Možnost naklapnutí; Zelená	<a href="http://www.wago.com/793-504/000-023">www.wago.com/793-504/000-023</a>
	<b>Obj. č.: 793-505</b> Popisovací karta WMB; Jako karta; S potiskem; 31–40 (10×); Neflexibilní; Potisk vodorovný; Možnost naklapnutí; Bílá	<a href="http://www.wago.com/793-505">www.wago.com/793-505</a>
	<b>Obj. č.: 793-505/000-005</b> Popisovací karta WMB; Jako karta; S potiskem; 31–40 (10×); Neflexibilní; Potisk vodorovný; Možnost naklapnutí; Červená	<a href="http://www.wago.com/793-505/000-005">www.wago.com/793-505/000-005</a>
	<b>Obj. č.: 793-505/000-006</b> Popisovací karta WMB; Jako karta; S potiskem; 31–40 (10×); Neflexibilní; Potisk vodorovný; Možnost naklapnutí; Modrá	<a href="http://www.wago.com/793-505/000-006">www.wago.com/793-505/000-006</a>
	<b>Obj. č.: 793-505/000-007</b> Popisovací karta WMB; Jako karta; S potiskem; 31–40 (10×); Neflexibilní; Potisk vodorovný; Možnost naklapnutí; Šedá	<a href="http://www.wago.com/793-505/000-007">www.wago.com/793-505/000-007</a>
	<b>Obj. č.: 793-505/000-012</b> Popisovací karta WMB; Jako karta; S potiskem; 31–40 (10×); Neflexibilní; Potisk vodorovný; Možnost naklapnutí; Oranžová	<a href="http://www.wago.com/793-505/000-012">www.wago.com/793-505/000-012</a>

	<b>Obj. č.: 793-506</b> Popisovací karta WMB; Jako karta; S potiskem; 41–50 (10×); Neflexibilní; Potisk vodorovný; Možnost naklapnutí; Bílá	<a href="http://www.wago.com/793-506">www.wago.com/793-506</a>
	<b>Obj. č.: 793-506/000-005</b> Popisovací karta WMB; Jako karta; S potiskem; 41–50 (10×); Neflexibilní; Potisk vodorovný; Možnost naklapnutí; Červená	<a href="http://www.wago.com/793-506/000-005">www.wago.com/793-506/000-005</a>
	<b>Obj. č.: 793-506/000-006</b> Popisovací karta WMB; Jako karta; S potiskem; 41–50 (10×); Neflexibilní; Potisk vodorovný; Možnost naklapnutí; Modrá	<a href="http://www.wago.com/793-506/000-006">www.wago.com/793-506/000-006</a>
	<b>Obj. č.: 793-506/000-012</b> Popisovací karta WMB; Jako karta; S potiskem; 41–50 (10×); Neflexibilní; Potisk vodorovný; Možnost naklapnutí; Oranžová	<a href="http://www.wago.com/793-506/000-012">www.wago.com/793-506/000-012</a>
	<b>Obj. č.: 793-506/000-017</b> Popisovací karta WMB; Jako karta; S potiskem; 41–50 (10×); Neflexibilní; Potisk vodorovný; Možnost naklapnutí; Světle zelená	<a href="http://www.wago.com/793-506/000-017">www.wago.com/793-506/000-017</a>
<b>Insulation stop</b>		
	<b>Obj. č.: 280-470</b> Izolační zarážka; 0,08–0,2 mm <sup>2</sup> „e“ (0,14 mm <sup>2</sup> „f“); 5 ks/pás; Bílá	<a href="http://www.wago.com/280-470">www.wago.com/280-470</a>
	<b>Obj. č.: 280-471</b> Izolační zarážka; 0,25–0,5 mm <sup>2</sup> ; 5 ks/pás; Světle šedá	<a href="http://www.wago.com/280-471">www.wago.com/280-471</a>
	<b>Obj. č.: 280-472</b> Izolační zarážka; 0,75–1 mm <sup>2</sup> ; 5 ks/pás	<a href="http://www.wago.com/280-472">www.wago.com/280-472</a>

## Ke stažení

### Documentation

#### Additional Information

Disposal; Electrical and electronic equipment, Packaging	V 1.0.0	pdf 265,8 kB	Stáhnout
--	---------	-----------------	----------

## CAD/CAE-Data

### CAD data

2D/3D Models 280-502/281-605	URL	Stáhnout
------------------------------	-----	----------

### CAE data

EPLAN Data Portal 280-502/281-605	Stáhnout
-----------------------------------	----------

WSCAD Universe 280-502/281-605	Stáhnout
--------------------------------	----------



## Handling Instructions

Změny vyhrazeny.

---

WAGO Elektro spol. sr. o.  
Rozvodova 1116/36  
143 00 Praha 12 - Modřany  
Tel.: +420 261 090 143  
Email: [info.cz@wago.com](mailto:info.cz@wago.com), [wago-cz@wago.com](mailto:wago-cz@wago.com)

Máte otázky ohledně našich produktů?  
Kdykoli nám zavolejte na číslo +420 261 090 143.