

## Datový list | Objednací číslo: 280-502/281-591

Svorka pro moduly; Dvoupatrová; S koncovou bočnicí a přímým připojením k DIN liště; S diodou 1.5KE82C TVS; DC 60 V; Na DIN lištu 35 × 15 a 35 × 7,5; 2,5 mm<sup>2</sup>; CAGE CLAMP®; 2,50 mm<sup>2</sup>; Šedá

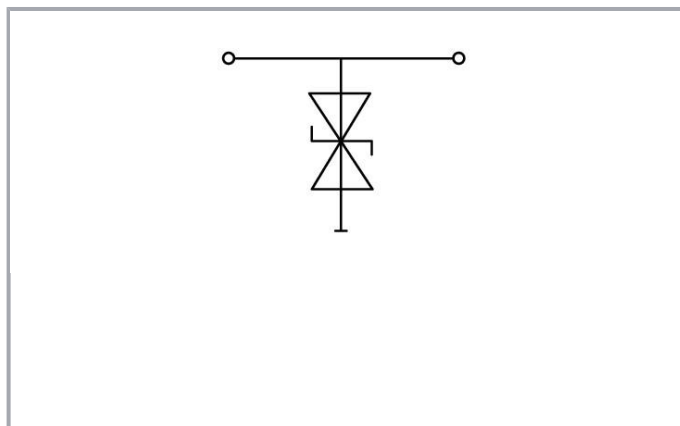

[www.wago.com/280-502/281-591](http://www.wago.com/280-502/281-591)

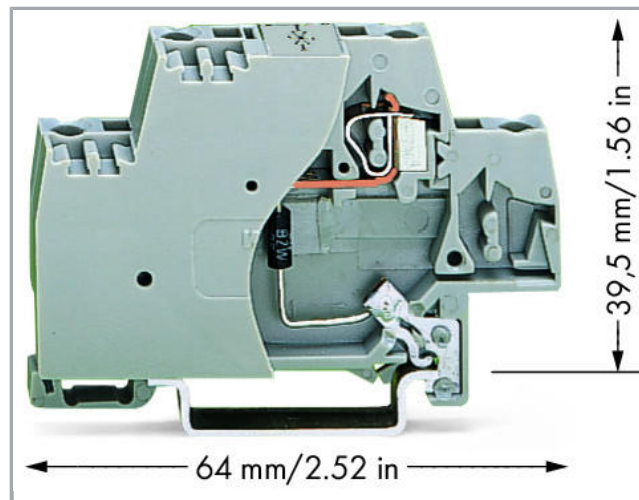
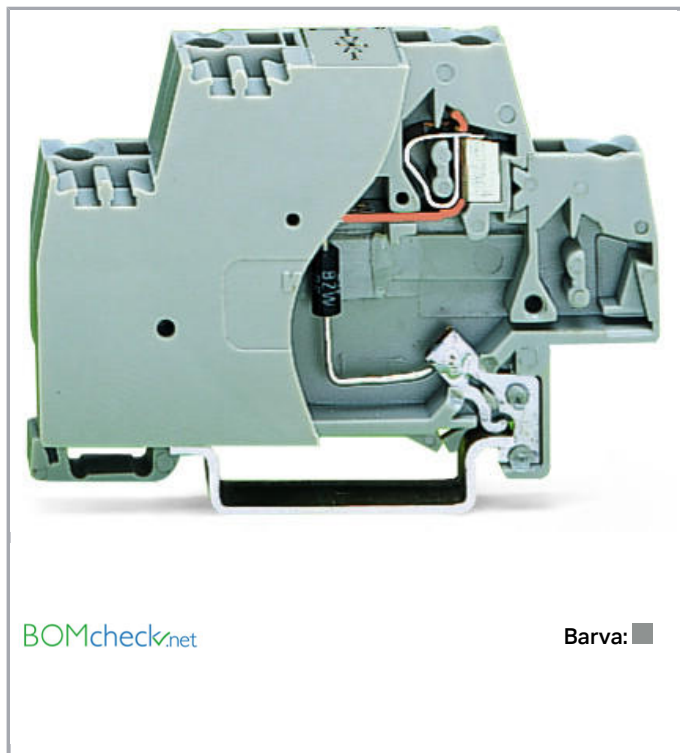

### Popis položky

#### Short description:

Terminal blocks with surge suppression device and direct connection to the DIN-35 rail; these single-stage surge suppression devices are equipped either with 280 Series gas-filled surge arrester (coarse), varistor (medium) or suppressor diode (fine).

#### Features:

- Protect your system against overvoltage



- Slim, space-saving design
- Control operational costs by preventing expensive, unplanned downtime
- High operational reliability and system uptime

## Data

### Elektrické parametry

Nominal operating voltage	DC 60 V
Maximální nepřetržitě provozní napětí	DC 70 V
Jmenovitý proud (max.)	20 A
Nominal discharge current (8/20 $\mu$ s) per line	69 A
Voltage protection level (8/20 $\mu$ s)	$\leq$ DC 146 V
Kapacita	$\leq$ 1,35 nF

### Údaje o připojení

Connections (number)	2
Připojovací technika	CAGE CLAMP®
Plný vodič	0,08 ... 2,5 mm <sup>2</sup> / 28 ... 14 AWG
Jemně laněný vodič	0,08 ... 2,5 mm <sup>2</sup> / 28 ... 14 AWG
Délka odizolování	8 ... 9 mm / 0.31 ... 0.35 palec

### Geometrické údaje

Šířka	10 mm / 0.394 inch
Výška od horní hrany lišty DIN 35	39,5 mm / 1.555 inch
Hloubka	64 mm / 2.52 inch

### Mechanické parametry

Provedení	With end plate; with direct connection to DIN rail
Způsob montáže	Lišta DIN 35

### Údaje o materiálu

barva	Šedá
Hmotnost	12.081

### Obchodní údaje

Product Group	1 (Rail Mounted Terminal Blocks)
Druh balení	BOX
Country of origin	DE
GTIN	4017332262781
Customs Tariff No.	85369010000

## Kompatibilní produkty

## tools



**Obj. č.: 210-720**  
Ovládací nástroj; Břit: 3,5 × 0,5 mm; S částečně izolovanou rukojetí

[www.wago.com/210-720](http://www.wago.com/210-720)

## Jumper



**Obj. č.: 280-482**  
Hřebenový můstek; Izolováno; 2×; IN = IN svorky; Šedá

[www.wago.com/280-482](http://www.wago.com/280-482)



**Obj. č.: 280-483**  
Hřebenový můstek; Izolováno; 3×; IN = IN svorky; Šedá

[www.wago.com/280-483](http://www.wago.com/280-483)



**Obj. č.: 280-484**  
Hřebenový můstek; Izolováno; 4×; IN = IN svorky; Šedá

[www.wago.com/280-484](http://www.wago.com/280-484)



**Obj. č.: 280-485**  
Hřebenový můstek; Izolováno; 5×; IN = IN svorky; Šedá

[www.wago.com/280-485](http://www.wago.com/280-485)



**Obj. č.: 280-490**  
Hřebenový můstek; Izolováno; 10×; IN = IN svorky; Šedá

[www.wago.com/280-490](http://www.wago.com/280-490)



**Obj. č.: 280-492**  
Hřebenový můstek ob svorku; Izolováno; 2×; IN = IN svorky; Šedá

[www.wago.com/280-492](http://www.wago.com/280-492)

## End plate



**Obj. č.: 280-340**  
Koncová bočnice a separátor; Tloušťka 2,5 mm; Šedá

[www.wago.com/280-340](http://www.wago.com/280-340)



**Obj. č.: 280-341**  
Koncová bočnice a separátor; Tloušťka 2,5 mm; Oranžová

[www.wago.com/280-341](http://www.wago.com/280-341)

## Insulation stop



**Obj. č.: 280-470**  
Izolační zarážka; 0,08–0,2 mm<sup>2</sup> „e“ (0,14 mm<sup>2</sup> „f“); 5 ks/pás; Bílá

[www.wago.com/280-470](http://www.wago.com/280-470)



**Obj. č.: 280-471**  
Izolační zarážka; 0,25–0,5 mm<sup>2</sup>; 5 ks/pás; Světle šedá

[www.wago.com/280-471](http://www.wago.com/280-471)



**Obj. č.: 280-472**  
Izolační zarážka; 0,75–1 mm<sup>2</sup>; 5 ks/pás

[www.wago.com/280-472](http://www.wago.com/280-472)

## Marking accessories



**Obj. č.: 2009-145**  
Mini-WSB Inline; Pro Smart Printer; Na cívce; Flexibilní, 5–5,2 mm; Bez potisku; Možnost naklapnutí; Bílá















[www.wago.com/2009-145](http://www.wago.com/2009-145)



**Obj. č.: 2009-145/000-002**  
Mini-WSB Inline; Pro Smart Printer; Na cívce; Flexibilní, 5–5,2 mm; Bez potisku; Možnost naklapnutí; Žlutá /000-002

[www.wago.com/2009-145](http://www.wago.com/2009-145)

**Obj. č.: 2009-145/000-005**

	Mini-WSB Inline; Pro Smart Printer; Na cívce; Flexibilní, 5–5,2 mm; Bez potisku; Možnost naklapnutí; Červená	<a href="http://www.wago.com/2009-145/000-005">www.wago.com/2009-145/000-005</a>
	<b>Obj. č.: 2009-145/000-006</b> Mini-WSB Inline; Pro Smart Printer; Na cívce; Flexibilní, 5–5,2 mm; Bez potisku; Možnost naklapnutí; Modrá	<a href="http://www.wago.com/2009-145/000-006">www.wago.com/2009-145/000-006</a>
	<b>Obj. č.: 2009-145/000-007</b> Mini-WSB Inline; Pro Smart Printer; Na cívce; Flexibilní, 5–5,2 mm; Bez potisku; Možnost naklapnutí; Šedá	<a href="http://www.wago.com/2009-145/000-007">www.wago.com/2009-145/000-007</a>
	<b>Obj. č.: 2009-145/000-012</b> Mini-WSB Inline; Pro Smart Printer; Na cívce; Flexibilní, 5–5,2 mm; Bez potisku; Možnost naklapnutí; Oranžová	<a href="http://www.wago.com/2009-145/000-012">www.wago.com/2009-145/000-012</a>
	<b>Obj. č.: 2009-145/000-023</b> Mini-WSB Inline; Pro Smart Printer; Na cívce; Flexibilní, 5–5,2 mm; Bez potisku; Možnost naklapnutí; Zelená	<a href="http://www.wago.com/2009-145/000-023">www.wago.com/2009-145/000-023</a>
	<b>Obj. č.: 2009-145/000-024</b> Mini-WSB Inline; Pro Smart Printer; Na cívce; Flexibilní, 5–5,2 mm; Bez potisku; Možnost naklapnutí; Fialová	<a href="http://www.wago.com/2009-145/000-024">www.wago.com/2009-145/000-024</a>
	<b>Obj. č.: 248-501</b> Systém rychlého popisování Mini-WSB; Bez potisku; Šířka štítků 5 mm; 10 řad po 10 štítcích na každé kartě	<a href="http://www.wago.com/248-501">www.wago.com/248-501</a>
	<b>Obj. č.: 248-501/000-002</b> Popisovací karta Mini-WSB; Jako karta; Neflexibilní; Bez potisku; Možnost naklapnutí; Žlutá	<a href="http://www.wago.com/248-501/000-002">www.wago.com/248-501/000-002</a>
	<b>Obj. č.: 248-501/000-005</b> Popisovací karta Mini-WSB; Jako karta; Neflexibilní; Bez potisku; Možnost naklapnutí; Červená	<a href="http://www.wago.com/248-501/000-005">www.wago.com/248-501/000-005</a>
	<b>Obj. č.: 248-501/000-006</b> Popisovací karta Mini-WSB; Jako karta; Neflexibilní; Bez potisku; Možnost naklapnutí; Modrá	<a href="http://www.wago.com/248-501/000-006">www.wago.com/248-501/000-006</a>
	<b>Obj. č.: 248-501/000-007</b> Popisovací karta Mini-WSB; Jako karta; Neflexibilní; Bez potisku; Možnost naklapnutí; Šedá	<a href="http://www.wago.com/248-501/000-007">www.wago.com/248-501/000-007</a>
	<b>Obj. č.: 248-501/000-012</b> Popisovací karta Mini-WSB; Jako karta; Neflexibilní; Bez potisku; Možnost naklapnutí; Oranžová	<a href="http://www.wago.com/248-501/000-012">www.wago.com/248-501/000-012</a>
	<b>Obj. č.: 248-501/000-017</b> Popisovací karta Mini-WSB; Jako karta; Neflexibilní; Bez potisku; Možnost naklapnutí; Světle zelená	<a href="http://www.wago.com/248-501/000-017">www.wago.com/248-501/000-017</a>
	<b>Obj. č.: 248-501/000-023</b> Popisovací karta Mini-WSB; Jako karta; Neflexibilní; Bez potisku; Možnost naklapnutí; Zelená	<a href="http://www.wago.com/248-501/000-023">www.wago.com/248-501/000-023</a>
	<b>Obj. č.: 248-501/000-024</b> Popisovací karta Mini-WSB; Jako karta; Neflexibilní; Bez potisku; Možnost naklapnutí; Fialová	<a href="http://www.wago.com/248-501/000-024">www.wago.com/248-501/000-024</a>

## Ke stažení

### Documentation

#### Additional Information

Disposal; Electrical and electronic equipment, Packaging	V 1.0.0	pdf 265,8 kB	Stáhnout
--	---------	-----------------	----------

### CAD/CAE-Data

#### CAD data

2D/3D Models 280-502/281-591	URL	Stáhnout
------------------------------	-----	----------

#### CAE data

EPLAN Data Portal 280-502/281-591	Stáhnout
-----------------------------------	----------

WSCAD Universe 280-502/281-591	Stáhnout
--------------------------------	----------

## Handling Instructions

Změny vyhrazeny.

WAGO Elektro spol. sr. o.  
Rozvodova 1116/36  
143 00 Praha 12 - Modřany  
Tel.: +420 261 090 143  
Email: [info.cz@wago.com](mailto:info.cz@wago.com), [wago-cz@wago.com](mailto:wago-cz@wago.com)

Máte otázky ohledně našich produktů?  
Kdykoli nám zavolejte na číslo +420 261 090 143.