

Datový list | Objednací číslo: 270-585

3vodičová svorka pro akční člen; S barevnými přívody vodiče; 2,5 mm²;
CAGE CLAMP®; 2,50 mm²; Šedá

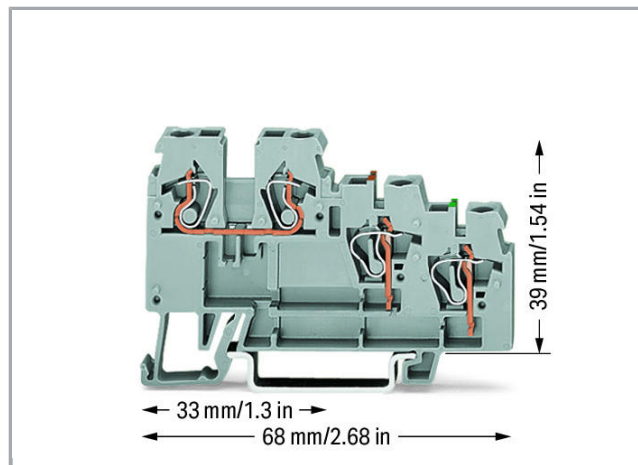

www.wago.com/270-585

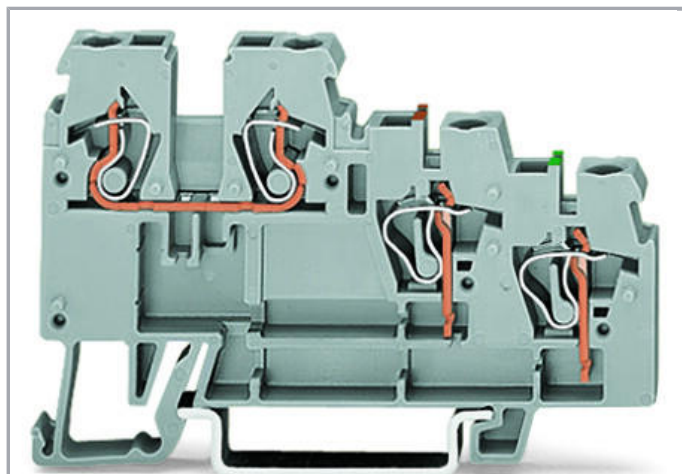

RoHS Compliant

[BOMcheck.net](https://www.bomcheck.net)

Barva: ■

S ○ ——— ○ S

■ + ○ ——— C

Ground (earth) ○ ——— C
Shield (screen)

Data

Elektrické parametry



Ratings per IEC/EN 60664-1

Návrhové napětí (III / 3)	250 V
Návrhové rázové napětí (III / 3)	4 kV
Jmenovitý proud	18 A
Legenda (návrhové hodnoty)	(III / 3) ≙ kategorie přepětí III / stupeň znečištění 3

Údaje o připojení

Připojovací technika	CAGE CLAMP®
Způsob ovládání	Ovládací nástroj
Materiály připojitelných vodičů	Měď
Plný vodič	0,08 ... 2,5 mm ² / 28 ... 12 AWG
Jemně laněný vodič	0,08 ... 2,5 mm ² / 28 ... 12 AWG
Délka odizolování	6 ... 7 mm / 0.24 ... 0.28 palec
Celkový počet kontaktních míst	4
Celkový počet potenciálů	3
Počet úrovní	3
Způsob zapojení	čelní připojení
Upozornění (průřez vodiče)	12 AWG: THHN, THWN

Geometrické údaje

Šířka	5 mm / 0.197 inch
Výška od horní hrany lišty DIN 35	39 mm / 1.535 inch
Hloubka	68 mm / 2.677 inch

Mechanické parametry

Provedení	Horizontální provedení
Způsob montáže	Lišta DIN 35
Úroveň popisování	Boční popis

Údaje o materiálu

barva	Šedá
Požární zatížení	0.172 MJ
Hmotnost	8.817 g



Obchodní údaje

Product Group	1 (Rail Mounted Terminal Blocks)
Druh balení	BOX
Country of origin	CN

GTIN	4050821035282
Customs Tariff No.	85369010000

Atesty/certifikáty

Specifické atesty jednotlivých států



Logo	Schválení	Doplňkový text schválení	Název certifikátu
	CCA DEKRA Certification B.V.	EN 60947	NTR NL 6828
	CCA DEKRA Certification B.V.	EN 60947	2143311.03
	CSA DEKRA Certification B.V.	C22.2	1565649

Atesty UL



Logo	Schválení	Doplňkový text schválení	Název certifikátu
	UR Underwriters Laboratories Inc.	UL 1059	20190731- E45172



















Kompatibilní produkty

















tools















	Obj. č.: 210-657 Ovládací nástroj; Břit: 3,5 × 0,5 mm; S částečně izolovanou rukojetí; Krátké	www.wago.com/210-657
	Obj. č.: 210-720 Ovládací nástroj; Břit: 3,5 × 0,5 mm; S částečně izolovanou rukojetí	www.wago.com/210-720

















ferrule

	Obj. č.: 216-121 Dutinka; Objímka na 0,5 mm ² / AWG 22; Bez plastového límce; Galvanicky pocínováno	www.wago.com/216-121
	Obj. č.: 216-122 Dutinka; Objímka na 0,75 mm ² / AWG 20; Bez plastového límce; Galvanicky pocínováno	www.wago.com/216-122

	Obj. č.: 216-123 Dutinka; Objímka na 1 mm ² / AWG 18; Bez plastového límce; Galvanicky pocínováno	www.wago.com/216-123
	Obj. č.: 216-124 Dutinka; Objímka na 1,5 mm ² / AWG 16; Bez plastového límce; Galvanicky pocínováno	www.wago.com/216-124
	Obj. č.: 216-131 Dutinka; Objímka na 0,25 mm ² / AWG 24; Bez plastového límce; Galvanicky pocínováno	www.wago.com/216-131
	Obj. č.: 216-132 Dutinka; Objímka na 0,34 mm ² / AWG 24; Bez plastového límce; Galvanicky pocínováno	www.wago.com/216-132
	Obj. č.: 216-221 Ferrule; Sleeve for 0.5 mm ² / 20 AWG; insulated; electro-tin plated; white	www.wago.com/216-221
	Obj. č.: 216-222 Ferrule; Sleeve for 0.75 mm ² / 18 AWG; insulated; electro-tin plated; gray	www.wago.com/216-222
	Obj. č.: 216-223 Dutinka; Objímka na 1 mm ² / AWG 18; S plastovým límcem; Galvanicky pocínováno; Červená	www.wago.com/216-223
	Obj. č.: 216-224 Dutinka; Objímka na 1,5 mm ² / AWG 16; S plastovým límcem; Galvanicky pocínováno; Černá	www.wago.com/216-224
	Obj. č.: 216-321 Dutinka; Objímka na 0,25 mm ² / AWG 24; S plastovým límcem; Galvanicky pocínováno; Žlutá	www.wago.com/216-321
	Obj. č.: 216-322 Ferrule; Sleeve for 0.34 mm ² / 22 AWG; insulated; electro-tin plated; green	www.wago.com/216-322
End plate		
	Obj. č.: 270-319 Koncová bočnice a separátor; Tloušťka 1 mm; Pro třípatrové svorky; Šedá	www.wago.com/270-319
	Obj. č.: 270-321 Koncová bočnice a separátor; Tloušťka 1 mm; Pro třípatrové svorky; Oranžová	www.wago.com/270-321
Jumper		
	Obj. č.: 270-409 Můstek; Čistý; 9×; Jmenovitý proud 18 A; Stříbrná	www.wago.com/270-409
	Obj. č.: 270-417 Můstek; Čistý; 17×; Jmenovitý proud 18 A; Stříbrná	www.wago.com/270-417
	Obj. č.: 270-480 Můstek; Čistý; 80×; Jmenovitý proud 18 A; Stříbrná	www.wago.com/270-480
	Obj. č.: 870-402 Hřebenový můstek; Izolováno; 2×; Jmenovitý proud 18 A; Světle šedá	www.wago.com/870-402
	Obj. č.: 870-403 Hřebenový můstek; Izolováno; 3×; Jmenovitý proud 18 A; Světle šedá	www.wago.com/870-403
	Obj. č.: 870-404 Push-in type jumper bar; insulated; 4-way; Nominal current 18 A; light gray	www.wago.com/870-404
	Obj. č.: 870-405 Hřebenový můstek; Izolováno; 5×; Jmenovitý proud 18 A; Světle šedá	www.wago.com/870-405

	<p>Obj. č.: 870-405/011-000 Ready-made push-in type jumper bar; insulated; 3-way (1-3-5); Nominal current 18 A; light gray</p>	www.wago.com/870-405/011-000
	<p>Obj. č.: 870-406 Hřebenový můstek; Izolováno; 6×; Jmenovitý proud 18 A; Světle šedá</p>	www.wago.com/870-406
	<p>Obj. č.: 870-407 Hřebenový můstek; Izolováno; 7×; Jmenovitý proud 18 A; Světle šedá</p>	www.wago.com/870-407
	<p>Obj. č.: 870-407/011-000 Ready-made push-in type jumper bar; insulated; 1-3-5-7; Nominal current 18 A; light gray</p>	www.wago.com/870-407/011-000
	<p>Obj. č.: 870-408 Hřebenový můstek; Izolováno; 8×; Jmenovitý proud 18 A; Světle šedá</p>	www.wago.com/870-408
	<p>Obj. č.: 870-409 Hřebenový můstek; Izolováno; 9×; Jmenovitý proud 18 A; Světle šedá</p>	www.wago.com/870-409
	<p>Obj. č.: 870-409/011-000 Ready-made push-in type jumper bar; insulated; 1-3-5-7-9; Nominal current 18 A; light gray</p>	www.wago.com/870-409/011-000
Insulation stop		
	<p>Obj. č.: 280-470 Izolační zářezka; 0,08–0,2 mm² „e“ (0,14 mm² „f“); 5 ks/pás; Bílá</p>	www.wago.com/280-470
	<p>Obj. č.: 280-471 Izolační zářezka; 0,25–0,5 mm²; 5 ks/pás; Světle šedá</p>	www.wago.com/280-471
	<p>Obj. č.: 280-472 Izolační zářezka; 0,75–1 mm²; 5 ks/pás</p>	www.wago.com/280-472
Marking accessories		
	<p>Obj. č.: 2009-115 WMB Inline; Pro Smart Printer; Na cívce; Flexibilní, 5–5,2 mm; Bez potisku; Možnost naklapnutí; Bílá</p>	www.wago.com/2009-115
	<p>Obj. č.: 2009-115/000-002 WMB Inline; Pro Smart Printer; Na cívce; Flexibilní, 5–5,2 mm; Bez potisku; Možnost naklapnutí; Žlutá</p>	www.wago.com/2009-115/000-002
	<p>Obj. č.: 2009-115/000-006 WMB Inline; Pro Smart Printer; Na cívce; Flexibilní, 5–5,2 mm; Bez potisku; Možnost naklapnutí; Modrá</p>	www.wago.com/2009-115/000-006
	<p>Obj. č.: 2009-115/000-007 WMB Inline; Pro Smart Printer; Na cívce; Flexibilní, 5–5,2 mm; Bez potisku; Možnost naklapnutí; Šedá</p>	www.wago.com/2009-115/000-007
	<p>Obj. č.: 2009-115/000-012 WMB Inline; Pro Smart Printer; Na cívce; Flexibilní, 5–5,2 mm; Bez potisku; Možnost naklapnutí; Oranžová</p>	www.wago.com/2009-115/000-012
	<p>Obj. č.: 2009-115/000-017 WMB Inline; Pro Smart Printer; Na cívce; Flexibilní, 5–5,2 mm; Bez potisku; Možnost naklapnutí; Světle zelená</p>	www.wago.com/2009-115/000-017
	<p>Obj. č.: 2009-115/000-023</p>	

	WMB Inline; Pro Smart Printer; Na cívce; Flexibilní, 5–5,2 mm; Bez potisku; Možnost naklapnutí; Zelená	www.wago.com/2009-115/000-023
	Obj. č.: 2009-115/000-024 WMB Inline; Pro Smart Printer; Na cívce; Flexibilní, 5–5,2 mm; Bez potisku; Možnost naklapnutí; Fialová	www.wago.com/2009-115/000-024
	Obj. č.: 2009-145 Mini-WSB Inline; Pro Smart Printer; Na cívce; Flexibilní, 5–5,2 mm; Bez potisku; Možnost naklapnutí; Bílá	www.wago.com/2009-145
	Obj. č.: 2009-145/000-002 Mini-WSB Inline; Pro Smart Printer; Na cívce; Flexibilní, 5–5,2 mm; Bez potisku; Možnost naklapnutí; Žlutá	www.wago.com/2009-145/000-002
	Obj. č.: 2009-145/000-005 Mini-WSB Inline; Pro Smart Printer; Na cívce; Flexibilní, 5–5,2 mm; Bez potisku; Možnost naklapnutí; Červená	www.wago.com/2009-145/000-005
	Obj. č.: 2009-145/000-006 Mini-WSB Inline; Pro Smart Printer; Na cívce; Flexibilní, 5–5,2 mm; Bez potisku; Možnost naklapnutí; Modrá	www.wago.com/2009-145/000-006
	Obj. č.: 2009-145/000-007 Mini-WSB Inline; Pro Smart Printer; Na cívce; Flexibilní, 5–5,2 mm; Bez potisku; Možnost naklapnutí; Šedá	www.wago.com/2009-145/000-007
	Obj. č.: 2009-145/000-012 Mini-WSB Inline; Pro Smart Printer; Na cívce; Flexibilní, 5–5,2 mm; Bez potisku; Možnost naklapnutí; Oranžová	www.wago.com/2009-145/000-012
	Obj. č.: 2009-145/000-023 Mini-WSB Inline; Pro Smart Printer; Na cívce; Flexibilní, 5–5,2 mm; Bez potisku; Možnost naklapnutí; Zelená	www.wago.com/2009-145/000-023
	Obj. č.: 2009-145/000-024 Mini-WSB Inline; Pro Smart Printer; Na cívce; Flexibilní, 5–5,2 mm; Bez potisku; Možnost naklapnutí; Fialová	www.wago.com/2009-145/000-024
	Obj. č.: 248-501 Systém rychlého popisování Mini-WSB; Bez potisku; Šířka štítků 5 mm; 10 řad po 10 štítcích na každé kartě	www.wago.com/248-501
	Obj. č.: 248-501/000-002 Popisovací karta Mini-WSB; Jako karta; Neflexibilní; Bez potisku; Možnost naklapnutí; Žlutá	www.wago.com/248-501/000-002
	Obj. č.: 248-501/000-005 Popisovací karta Mini-WSB; Jako karta; Neflexibilní; Bez potisku; Možnost naklapnutí; Červená	www.wago.com/248-501/000-005
	Obj. č.: 248-501/000-006 Popisovací karta Mini-WSB; Jako karta; Neflexibilní; Bez potisku; Možnost naklapnutí; Modrá	www.wago.com/248-501/000-006
	Obj. č.: 248-501/000-007 Popisovací karta Mini-WSB; Jako karta; Neflexibilní; Bez potisku; Možnost naklapnutí; Šedá	www.wago.com/248-501/000-007

	<p>Obj. č.: 248-501/000-012 Popisovací karta Mini-WSB; Jako karta; Neflexibilní; Bez potisku; Možnost naklapnutí; Oranžová</p>	<p>www.wago.com/248-501/000-012</p>
	<p>Obj. č.: 248-501/000-017 Popisovací karta Mini-WSB; Jako karta; Neflexibilní; Bez potisku; Možnost naklapnutí; Světle zelená</p>	<p>www.wago.com/248-501/000-017</p>
	<p>Obj. č.: 248-501/000-023 Popisovací karta Mini-WSB; Jako karta; Neflexibilní; Bez potisku; Možnost naklapnutí; Zelená</p>	<p>www.wago.com/248-501/000-023</p>
	<p>Obj. č.: 248-501/000-024 Popisovací karta Mini-WSB; Jako karta; Neflexibilní; Bez potisku; Možnost naklapnutí; Fialová</p>	<p>www.wago.com/248-501/000-024</p>
	<p>Obj. č.: 709-177 Popisovací páska; Na cívce; Šířka 7,5 mm; Neflexibilní; Bez potisku; Možnost naklapnutí; Průsvitná</p>	<p>www.wago.com/709-177</p>
	<p>Obj. č.: 709-178 Popisovací páska; Na cívce; Šířka 7,5 mm; Neflexibilní; Bez potisku; Možnost naklapnutí; Bílá</p>	<p>www.wago.com/709-178</p>
	<p>Obj. č.: 709-196 Popisovací páska; Pro laserové tiskárny; Průsvitná</p>	<p>www.wago.com/709-196</p>
	<p>Obj. č.: 709-198 Popisovací páska; Bílá</p>	<p>www.wago.com/709-198</p>
	<p>Obj. č.: 793-501 Popisovací karta WMB; Jako karta; Neflexibilní; Bez potisku; Možnost naklapnutí; Bílá</p>	<p>www.wago.com/793-501</p>
	<p>Obj. č.: 793-501/000-002 Popisovací karta WMB; Jako karta; Neflexibilní; Bez potisku; Možnost naklapnutí; Bílá</p>	<p>www.wago.com/793-501/000-002</p>
	<p>Obj. č.: 793-501/000-005 Popisovací karta WMB; Jako karta; Neflexibilní; Bez potisku; Možnost naklapnutí; Červená</p>	<p>www.wago.com/793-501/000-005</p>
	<p>Obj. č.: 793-501/000-006 Popisovací karta WMB; Jako karta; Neflexibilní; Bez potisku; Možnost naklapnutí; Modrá</p>	<p>www.wago.com/793-501/000-006</p>
	<p>Obj. č.: 793-501/000-007 Popisovací karta WMB; Jako karta; Neflexibilní; Bez potisku; Možnost naklapnutí; Šedá</p>	<p>www.wago.com/793-501/000-007</p>
	<p>Obj. č.: 793-501/000-012 Popisovací karta WMB; Jako karta; Neflexibilní; Bez potisku; Možnost naklapnutí; Oranžová</p>	<p>www.wago.com/793-501/000-012</p>
	<p>Obj. č.: 793-501/000-017 Popisovací karta WMB; Jako karta; Neflexibilní; Bez potisku; Možnost naklapnutí; Světle zelená</p>	<p>www.wago.com/793-501/000-017</p>
	<p>Obj. č.: 793-501/000-023 Popisovací karta WMB; Jako karta; Neflexibilní; Bez potisku; Možnost naklapnutí; Zelená</p>	<p>www.wago.com/793-501/000-023</p>



Obj. č.: 793-501/000-024
Popisovací karta WMB; Jako karta; Neflexibilní; Bez potisku; Možnost naklapnutí; Fialová

www.wago.com/793-501/000-024



Obj. č.: 793-5501
Popisovací karta WMB; Jako karta; Pro svorky o šířce 5–17,5 mm; Flexibilní, 5–5,2 mm; Bez potisku; Možnost naklapnutí; Bílá

www.wago.com/793-5501



Obj. č.: 793-5501/000-002
Popisovací karta WMB; Jako karta; Pro svorky o šířce 5–17,5 mm; Flexibilní, 5–5,2 mm; Bez potisku; Možnost naklapnutí; Žlutá

www.wago.com/793-5501/000-002



Obj. č.: 793-5501/000-005
Popisovací karta WMB; Jako karta; Flexibilní, 5–5,2 mm; Bez potisku; Možnost naklapnutí; Červená

www.wago.com/793-5501/000-005



Obj. č.: 793-5501/000-006
Popisovací karta WMB; Jako karta; Flexibilní, 5–5,2 mm; Bez potisku; Možnost naklapnutí; Modrá

www.wago.com/793-5501/000-006



Obj. č.: 793-5501/000-007
Popisovací karta WMB; Jako karta; Flexibilní, 5–5,2 mm; Bez potisku; Možnost naklapnutí; Šedá

www.wago.com/793-5501/000-007



Obj. č.: 793-5501/000-012
Popisovací karta WMB; Jako karta; Flexibilní, 5–5,2 mm; Bez potisku; Možnost naklapnutí; Oranžová

www.wago.com/793-5501/000-012



Obj. č.: 793-5501/000-017
Popisovací karta WMB; Jako karta; Flexibilní, 5–5,2 mm; Bez potisku; Možnost naklapnutí; Světle zelená

www.wago.com/793-5501/000-017



Obj. č.: 793-5501/000-023
Popisovací karta WMB; Jako karta; Flexibilní, 5–5,2 mm; Bez potisku; Možnost naklapnutí; Zelená

www.wago.com/793-5501/000-023



Obj. č.: 793-5501/000-024
Popisovací karta WMB; Jako karta; Flexibilní, 5–5,2 mm; Bez potisku; Možnost naklapnutí; Fialová

www.wago.com/793-5501/000-024

Ke stažení

Documentation

Additional Information

Technical explanations	03-Apr-2019	pdf 2,1 MB	Stáhnout
------------------------	-------------	---------------	----------

CAD/CAE-Data

CAD data

2D/3D Models 270-585	URL	Stáhnout
----------------------	-----	----------

CAE data

EPLAN Data Portal 270-585

Handling Instructions

Jumpered

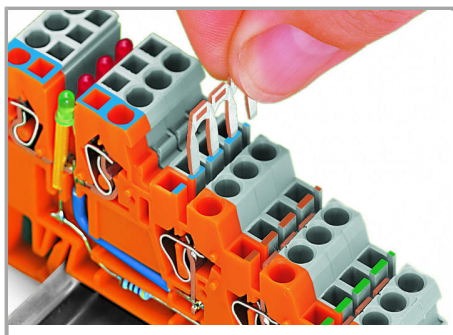

Inserting a jumper.

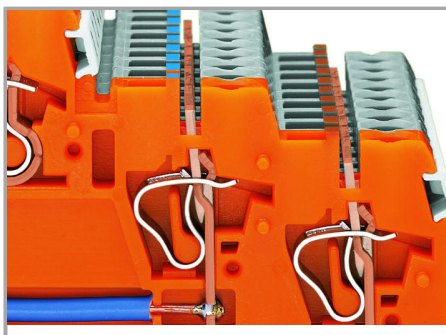

Commoning a supply voltage using uninsulated push-in type jumper bars, 2- to 9-way or 17-way (2 x 8 bits), depending on application.



Commoning signal level voltage via insulated push-in type jumper bars (870 Series) – 2- to 9-way, depending on application.

Sensor LED terminal blocks cannot be commoned!

Marking

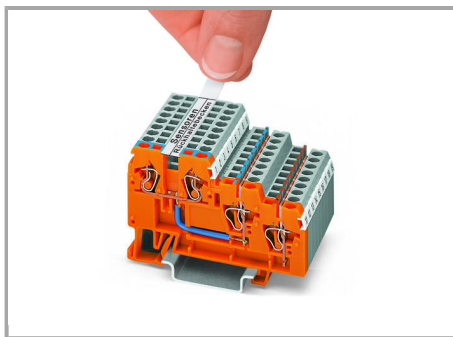

Marking strip (Item No. 709-196)

Not suitable for LED terminal blocks!

Změny vyhrazeny.