

Datový list | Objednací číslo: 270-572

3vodičová svorka pro akční člen; S barevnými přívody vodiče; 2,5 mm<sup>2</sup>;  
CAGE CLAMP®; 2,50 mm<sup>2</sup>; Šedá

[www.wago.com/270-572](http://www.wago.com/270-572)

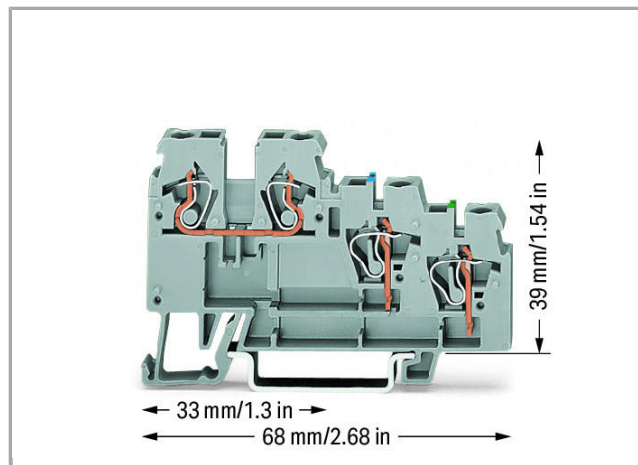
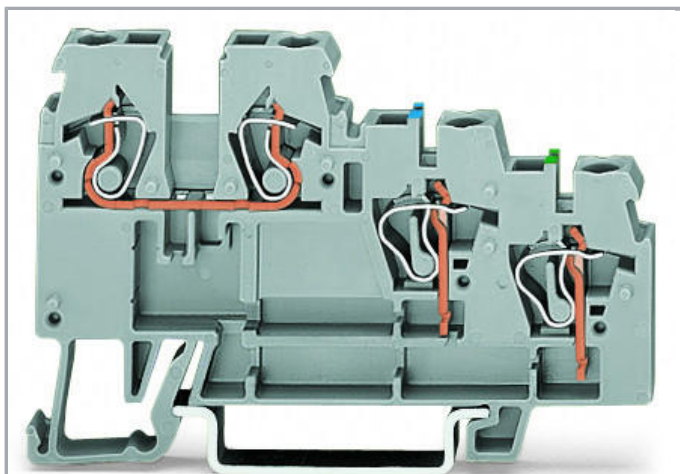

RoHS  Compliant

[BOMcheck.net](https://www.bomcheck.net)

Barva: ■

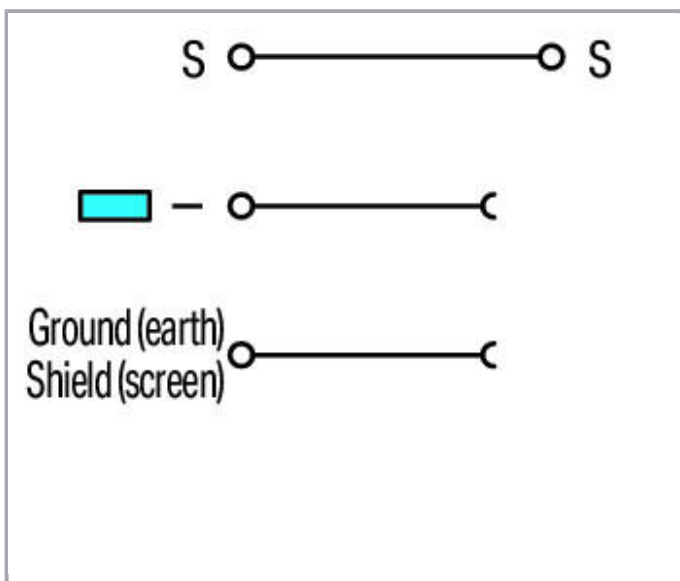

Data

Elektrické parametry



### Ratings per IEC/EN 60664-1

Návrhové napětí (III / 3)	250 V
Návrhové rázové napětí (III / 3)	4 kV
Jmenovitý proud	18 A
Legenda (návrhové hodnoty)	(III / 3) ≙ kategorie přepětí III / stupeň znečištění 3

### Údaje o připojení

Připojovací technika	CAGE CLAMP®
Způsob ovládání	Ovládací nástroj
Materiály připojitelných vodičů	Měď
Plný vodič	0,08 ... 2,5 mm <sup>2</sup> / 28 ... 12 AWG
Jemně laněný vodič	0,08 ... 2,5 mm <sup>2</sup> / 28 ... 12 AWG
Délka odizolování	6 ... 7 mm / 0.24 ... 0.28 palec
Celkový počet kontaktních míst	4
Celkový počet potenciálů	3
Počet úrovní	3
Způsob zapojení	čelní připojení
Upozornění (průřez vodiče)	12 AWG: THHN, THWN

### Geometrické údaje

Šířka	5 mm / 0.197 inch
Výška od horní hrany lišty DIN 35	39 mm / 1.535 inch
Hloubka	68 mm / 2.677 inch

### Mechanické parametry

Provedení	Horizontální provedení
Způsob montáže	Lišta DIN 35
Úroveň popisování	Boční popis

### Údaje o materiálu

barva	Šedá
Požární zatížení	0.172 MJ
Hmotnost	8.817 g



### Obchodní údaje

Product Group	1 (Rail Mounted Terminal Blocks)
Druh balení	BOX
Country of origin	CN

GTIN	4050821035268
Customs Tariff No.	85369010000

## Atesty/certifikáty

### Specifické atesty jednotlivých států



Logo	Schválení	Doplňkový text schválení	Název certifikátu
	CCA DEKRA Certification B.V.	EN 60947	NTR NL 6828
	CCA DEKRA Certification B.V.	EN 60947	2143311.03
	CSA DEKRA Certification B.V.	C22.2	1565649

### Atesty UL

















Logo	Schválení	Doplňkový text schválení	Název certifikátu
	UR Underwriters Laboratories Inc.	UL 1059	20190731- E45172

## Kompatibilní produkty

### Marking accessories

	Obj. č.: 2009-115 WMB Inline; Pro Smart Printer; Na cívce; Flexibilní, 5–5,2 mm; Bez potisku; Možnost naklapnutí; Bílá	<a href="http://www.wago.com/2009-115">www.wago.com/2009-115</a>
	Obj. č.: 2009-115/000-002 WMB Inline; Pro Smart Printer; Na cívce; Flexibilní, 5–5,2 mm; Bez potisku; Možnost naklapnutí; Žlutá	<a href="http://www.wago.com/2009-115/000-002">www.wago.com/2009-115/000-002</a>
	Obj. č.: 2009-115/000-006 WMB Inline; Pro Smart Printer; Na cívce; Flexibilní, 5–5,2 mm; Bez potisku; Možnost naklapnutí; Modrá	<a href="http://www.wago.com/2009-115/000-006">www.wago.com/2009-115/000-006</a>

	<b>Obj. č.: 2009-115/000-007</b> WMB Inline; Pro Smart Printer; Na cívce; Flexibilní, 5–5,2 mm; Bez potisku; Možnost naklapnutí; Šedá	<a href="http://www.wago.com/2009-115/000-007">www.wago.com/2009-115/000-007</a>
	<b>Obj. č.: 2009-115/000-012</b> WMB Inline; Pro Smart Printer; Na cívce; Flexibilní, 5–5,2 mm; Bez potisku; Možnost naklapnutí; Oranžová	<a href="http://www.wago.com/2009-115/000-012">www.wago.com/2009-115/000-012</a>
	<b>Obj. č.: 2009-115/000-017</b> WMB Inline; Pro Smart Printer; Na cívce; Flexibilní, 5–5,2 mm; Bez potisku; Možnost naklapnutí; Světle zelená	<a href="http://www.wago.com/2009-115/000-017">www.wago.com/2009-115/000-017</a>
	<b>Obj. č.: 2009-115/000-023</b> WMB Inline; Pro Smart Printer; Na cívce; Flexibilní, 5–5,2 mm; Bez potisku; Možnost naklapnutí; Zelená	<a href="http://www.wago.com/2009-115/000-023">www.wago.com/2009-115/000-023</a>
	<b>Obj. č.: 2009-115/000-024</b> WMB Inline; Pro Smart Printer; Na cívce; Flexibilní, 5–5,2 mm; Bez potisku; Možnost naklapnutí; Fialová	<a href="http://www.wago.com/2009-115/000-024">www.wago.com/2009-115/000-024</a>
	<b>Obj. č.: 2009-145</b> Mini-WSB Inline; Pro Smart Printer; Na cívce; Flexibilní, 5–5,2 mm; Bez potisku; Možnost naklapnutí; Bílá	<a href="http://www.wago.com/2009-145">www.wago.com/2009-145</a>
	<b>Obj. č.: 2009-145/000-002</b> Mini-WSB Inline; Pro Smart Printer; Na cívce; Flexibilní, 5–5,2 mm; Bez potisku; Možnost naklapnutí; Žlutá	<a href="http://www.wago.com/2009-145/000-002">www.wago.com/2009-145/000-002</a>
	<b>Obj. č.: 2009-145/000-005</b> Mini-WSB Inline; Pro Smart Printer; Na cívce; Flexibilní, 5–5,2 mm; Bez potisku; Možnost naklapnutí; Červená	<a href="http://www.wago.com/2009-145/000-005">www.wago.com/2009-145/000-005</a>
	<b>Obj. č.: 2009-145/000-006</b> Mini-WSB Inline; Pro Smart Printer; Na cívce; Flexibilní, 5–5,2 mm; Bez potisku; Možnost naklapnutí; Modrá	<a href="http://www.wago.com/2009-145/000-006">www.wago.com/2009-145/000-006</a>
	<b>Obj. č.: 2009-145/000-007</b> Mini-WSB Inline; Pro Smart Printer; Na cívce; Flexibilní, 5–5,2 mm; Bez potisku; Možnost naklapnutí; Šedá	<a href="http://www.wago.com/2009-145/000-007">www.wago.com/2009-145/000-007</a>
	<b>Obj. č.: 2009-145/000-012</b> Mini-WSB Inline; Pro Smart Printer; Na cívce; Flexibilní, 5–5,2 mm; Bez potisku; Možnost naklapnutí; Oranžová	<a href="http://www.wago.com/2009-145/000-012">www.wago.com/2009-145/000-012</a>
	<b>Obj. č.: 2009-145/000-023</b> Mini-WSB Inline; Pro Smart Printer; Na cívce; Flexibilní, 5–5,2 mm; Bez potisku; Možnost naklapnutí; Zelená	<a href="http://www.wago.com/2009-145/000-023">www.wago.com/2009-145/000-023</a>
	<b>Obj. č.: 2009-145/000-024</b> Mini-WSB Inline; Pro Smart Printer; Na cívce; Flexibilní, 5–5,2 mm; Bez potisku; Možnost naklapnutí; Fialová	<a href="http://www.wago.com/2009-145/000-024">www.wago.com/2009-145/000-024</a>
	<b>Obj. č.: 248-501</b> Systém rychlého popisování Mini-WSB; Bez potisku; Šířka štítků 5 mm; 10 řad po 10 štítcích na každé kartě	<a href="http://www.wago.com/248-501">www.wago.com/248-501</a>
	<b>Obj. č.: 248-501/000-002</b> Popisovací karta Mini-WSB; Jako karta; Neflexibilní; Bez potisku; Možnost naklapnutí; Žlutá	<a href="http://www.wago.com/248-501/000-002">www.wago.com/248-501/000-002</a>

	<b>Obj. č.: 248-501/000-005</b> Popisovací karta Mini-WSB; Jako karta; Neflexibilní; Bez potisku; Možnost naklapnutí; Červená	<a href="http://www.wago.com/248-501/000-005">www.wago.com/248-501/000-005</a>
	<b>Obj. č.: 248-501/000-006</b> Popisovací karta Mini-WSB; Jako karta; Neflexibilní; Bez potisku; Možnost naklapnutí; Modrá	<a href="http://www.wago.com/248-501/000-006">www.wago.com/248-501/000-006</a>
	<b>Obj. č.: 248-501/000-007</b> Popisovací karta Mini-WSB; Jako karta; Neflexibilní; Bez potisku; Možnost naklapnutí; Šedá	<a href="http://www.wago.com/248-501/000-007">www.wago.com/248-501/000-007</a>
	<b>Obj. č.: 248-501/000-012</b> Popisovací karta Mini-WSB; Jako karta; Neflexibilní; Bez potisku; Možnost naklapnutí; Oranžová	<a href="http://www.wago.com/248-501/000-012">www.wago.com/248-501/000-012</a>
	<b>Obj. č.: 248-501/000-017</b> Popisovací karta Mini-WSB; Jako karta; Neflexibilní; Bez potisku; Možnost naklapnutí; Světle zelená	<a href="http://www.wago.com/248-501/000-017">www.wago.com/248-501/000-017</a>
	<b>Obj. č.: 248-501/000-023</b> Popisovací karta Mini-WSB; Jako karta; Neflexibilní; Bez potisku; Možnost naklapnutí; Zelená	<a href="http://www.wago.com/248-501/000-023">www.wago.com/248-501/000-023</a>
	<b>Obj. č.: 248-501/000-024</b> Popisovací karta Mini-WSB; Jako karta; Neflexibilní; Bez potisku; Možnost naklapnutí; Fialová	<a href="http://www.wago.com/248-501/000-024">www.wago.com/248-501/000-024</a>
	<b>Obj. č.: 709-177</b> Popisovací páska; Na cívce; Šířka 7,5 mm; Neflexibilní; Bez potisku; Možnost naklapnutí; Průsvitná	<a href="http://www.wago.com/709-177">www.wago.com/709-177</a>
	<b>Obj. č.: 709-178</b> Popisovací páska; Na cívce; Šířka 7,5 mm; Neflexibilní; Bez potisku; Možnost naklapnutí; Bílá	<a href="http://www.wago.com/709-178">www.wago.com/709-178</a>
	<b>Obj. č.: 709-196</b> Popisovací páska; Pro laserové tiskárny; Průsvitná	<a href="http://www.wago.com/709-196">www.wago.com/709-196</a>
	<b>Obj. č.: 709-198</b> Popisovací páska; Bílá	<a href="http://www.wago.com/709-198">www.wago.com/709-198</a>
	<b>Obj. č.: 793-501</b> Popisovací karta WMB; Jako karta; Neflexibilní; Bez potisku; Možnost naklapnutí; Bílá	<a href="http://www.wago.com/793-501">www.wago.com/793-501</a>
	<b>Obj. č.: 793-501/000-002</b> Popisovací karta WMB; Jako karta; Neflexibilní; Bez potisku; Možnost naklapnutí; Bílá	<a href="http://www.wago.com/793-501/000-002">www.wago.com/793-501/000-002</a>
	<b>Obj. č.: 793-501/000-005</b> Popisovací karta WMB; Jako karta; Neflexibilní; Bez potisku; Možnost naklapnutí; Červená	<a href="http://www.wago.com/793-501/000-005">www.wago.com/793-501/000-005</a>
	<b>Obj. č.: 793-501/000-006</b> Popisovací karta WMB; Jako karta; Neflexibilní; Bez potisku; Možnost naklapnutí; Modrá	<a href="http://www.wago.com/793-501/000-006">www.wago.com/793-501/000-006</a>
	<b>Obj. č.: 793-501/000-007</b> Popisovací karta WMB; Jako karta; Neflexibilní; Bez potisku; Možnost naklapnutí; Šedá	<a href="http://www.wago.com/793-501/000-007">www.wago.com/793-501/000-007</a>



**Obj. č.: 793-501/000-012**  
Popisovací karta WMB; Jako karta; Neflexibilní; Bez potisku; Možnost naklapnutí; Oranžová

[www.wago.com/793-501/000-012](http://www.wago.com/793-501/000-012)



**Obj. č.: 793-501/000-017**  
Popisovací karta WMB; Jako karta; Neflexibilní; Bez potisku; Možnost naklapnutí; Světle zelená

[www.wago.com/793-501/000-017](http://www.wago.com/793-501/000-017)



**Obj. č.: 793-501/000-023**  
Popisovací karta WMB; Jako karta; Neflexibilní; Bez potisku; Možnost naklapnutí; Zelená

[www.wago.com/793-501/000-023](http://www.wago.com/793-501/000-023)



**Obj. č.: 793-501/000-024**  
Popisovací karta WMB; Jako karta; Neflexibilní; Bez potisku; Možnost naklapnutí; Fialová

[www.wago.com/793-501/000-024](http://www.wago.com/793-501/000-024)



**Obj. č.: 793-5501**  
Popisovací karta WMB; Jako karta; Pro svorky o šířce 5–17,5 mm; Flexibilní, 5–5,2 mm; Bez potisku; Možnost naklapnutí; Bílá

[www.wago.com/793-5501](http://www.wago.com/793-5501)



**Obj. č.: 793-5501/000-002**  
Popisovací karta WMB; Jako karta; Pro svorky o šířce 5–17,5 mm; Flexibilní, 5–5,2 mm; Bez potisku; Možnost naklapnutí; Žlutá

[www.wago.com/793-5501/000-002](http://www.wago.com/793-5501/000-002)



**Obj. č.: 793-5501/000-005**  
Popisovací karta WMB; Jako karta; Flexibilní, 5–5,2 mm; Bez potisku; Možnost naklapnutí; Červená

[www.wago.com/793-5501/000-005](http://www.wago.com/793-5501/000-005)



**Obj. č.: 793-5501/000-006**  
Popisovací karta WMB; Jako karta; Flexibilní, 5–5,2 mm; Bez potisku; Možnost naklapnutí; Modrá

[www.wago.com/793-5501/000-006](http://www.wago.com/793-5501/000-006)



**Obj. č.: 793-5501/000-007**  
Popisovací karta WMB; Jako karta; Flexibilní, 5–5,2 mm; Bez potisku; Možnost naklapnutí; Šedá

[www.wago.com/793-5501/000-007](http://www.wago.com/793-5501/000-007)



**Obj. č.: 793-5501/000-012**  
Popisovací karta WMB; Jako karta; Flexibilní, 5–5,2 mm; Bez potisku; Možnost naklapnutí; Oranžová

[www.wago.com/793-5501/000-012](http://www.wago.com/793-5501/000-012)



**Obj. č.: 793-5501/000-017**  
Popisovací karta WMB; Jako karta; Flexibilní, 5–5,2 mm; Bez potisku; Možnost naklapnutí; Světle zelená

[www.wago.com/793-5501/000-017](http://www.wago.com/793-5501/000-017)



**Obj. č.: 793-5501/000-023**  
Popisovací karta WMB; Jako karta; Flexibilní, 5–5,2 mm; Bez potisku; Možnost naklapnutí; Zelená

[www.wago.com/793-5501/000-023](http://www.wago.com/793-5501/000-023)



**Obj. č.: 793-5501/000-024**  
Popisovací karta WMB; Jako karta; Flexibilní, 5–5,2 mm; Bez potisku; Možnost naklapnutí; Fialová

[www.wago.com/793-5501/000-024](http://www.wago.com/793-5501/000-024)

#### tools



**Obj. č.: 210-657**  
Ovládací nástroj; Břit: 3,5 × 0,5 mm; S částečně izolovanou rukojetí; Krátké

















[www.wago.com/210-657](http://www.wago.com/210-657)















**Obj. č.: 210-720**  
Ovládací nástroj; Břit: 3,5 × 0,5 mm; S částečně izolovanou rukojetí

[www.wago.com/210-720](http://www.wago.com/210-720)

#### Jumper

	<b>Obj. č.: 270-409</b> Můstek; Čistý; 9×; Jmenovitý proud 18 A; Stříbrná	<a href="http://www.wago.com/270-409">www.wago.com/270-409</a>
	<b>Obj. č.: 270-417</b> Můstek; Čistý; 17×; Jmenovitý proud 18 A; Stříbrná	<a href="http://www.wago.com/270-417">www.wago.com/270-417</a>
	<b>Obj. č.: 270-480</b> Můstek; Čistý; 80×; Jmenovitý proud 18 A; Stříbrná	<a href="http://www.wago.com/270-480">www.wago.com/270-480</a>
	<b>Obj. č.: 870-402</b> Hřebenový můstek; Izolováno; 2×; Jmenovitý proud 18 A; Světle šedá	<a href="http://www.wago.com/870-402">www.wago.com/870-402</a>
	<b>Obj. č.: 870-403</b> Hřebenový můstek; Izolováno; 3×; Jmenovitý proud 18 A; Světle šedá	<a href="http://www.wago.com/870-403">www.wago.com/870-403</a>
	<b>Obj. č.: 870-404</b> Push-in type jumper bar; insulated; 4-way; Nominal current 18 A; light gray	<a href="http://www.wago.com/870-404">www.wago.com/870-404</a>
	<b>Obj. č.: 870-405</b> Hřebenový můstek; Izolováno; 5×; Jmenovitý proud 18 A; Světle šedá	<a href="http://www.wago.com/870-405">www.wago.com/870-405</a>
	<b>Obj. č.: 870-405/011-000</b> Ready-made push-in type jumper bar; insulated; 3-way (1-3-5); Nominal current 18 A; light gray	<a href="http://www.wago.com/870-405/011-000">www.wago.com/870-405/011-000</a>
	<b>Obj. č.: 870-406</b> Hřebenový můstek; Izolováno; 6×; Jmenovitý proud 18 A; Světle šedá	<a href="http://www.wago.com/870-406">www.wago.com/870-406</a>
	<b>Obj. č.: 870-407</b> Hřebenový můstek; Izolováno; 7×; Jmenovitý proud 18 A; Světle šedá	<a href="http://www.wago.com/870-407">www.wago.com/870-407</a>
	<b>Obj. č.: 870-407/011-000</b> Ready-made push-in type jumper bar; insulated; 1-3-5-7; Nominal current 18 A; light gray	<a href="http://www.wago.com/870-407/011-000">www.wago.com/870-407/011-000</a>
	<b>Obj. č.: 870-408</b> Hřebenový můstek; Izolováno; 8×; Jmenovitý proud 18 A; Světle šedá	<a href="http://www.wago.com/870-408">www.wago.com/870-408</a>
	<b>Obj. č.: 870-409</b> Hřebenový můstek; Izolováno; 9×; Jmenovitý proud 18 A; Světle šedá	<a href="http://www.wago.com/870-409">www.wago.com/870-409</a>
	<b>Obj. č.: 870-409/011-000</b> Ready-made push-in type jumper bar; insulated; 1-3-5-7-9; Nominal current 18 A; light gray	<a href="http://www.wago.com/870-409/011-000">www.wago.com/870-409/011-000</a>
<b>ferrule</b>		
	<b>Obj. č.: 216-121</b> Dutinka; Objímka na 0,5 mm <sup>2</sup> / AWG 22; Bez plastového límce; Galvanicky pocínováno	<a href="http://www.wago.com/216-121">www.wago.com/216-121</a>
	<b>Obj. č.: 216-122</b> Dutinka; Objímka na 0,75 mm <sup>2</sup> / AWG 20; Bez plastového límce; Galvanicky pocínováno	<a href="http://www.wago.com/216-122">www.wago.com/216-122</a>
	<b>Obj. č.: 216-123</b> Dutinka; Objímka na 1 mm <sup>2</sup> / AWG 18; Bez plastového límce; Galvanicky pocínováno	<a href="http://www.wago.com/216-123">www.wago.com/216-123</a>
	<b>Obj. č.: 216-124</b> Dutinka; Objímka na 1,5 mm <sup>2</sup> / AWG 16; Bez plastového límce; Galvanicky pocínováno	<a href="http://www.wago.com/216-124">www.wago.com/216-124</a>

	<b>Obj. č.: 216-131</b> Dutinka; Objímka na 0,25 mm <sup>2</sup> / AWG 24; Bez plastového límce; Galvanicky pocínováno	<a href="http://www.wago.com/216-131">www.wago.com/216-131</a>
	<b>Obj. č.: 216-132</b> Dutinka; Objímka na 0,34 mm <sup>2</sup> / AWG 24; Bez plastového límce; Galvanicky pocínováno	<a href="http://www.wago.com/216-132">www.wago.com/216-132</a>
	<b>Obj. č.: 216-221</b> Ferrule; Sleeve for 0.5 mm <sup>2</sup> / 20 AWG; insulated; electro-tin plated; white	<a href="http://www.wago.com/216-221">www.wago.com/216-221</a>
	<b>Obj. č.: 216-222</b> Ferrule; Sleeve for 0.75 mm <sup>2</sup> / 18 AWG; insulated; electro-tin plated; gray	<a href="http://www.wago.com/216-222">www.wago.com/216-222</a>
	<b>Obj. č.: 216-223</b> Dutinka; Objímka na 1 mm <sup>2</sup> / AWG 18; S plastovým límcem; Galvanicky pocínováno; Červená	<a href="http://www.wago.com/216-223">www.wago.com/216-223</a>
	<b>Obj. č.: 216-224</b> Dutinka; Objímka na 1,5 mm <sup>2</sup> / AWG 16; S plastovým límcem; Galvanicky pocínováno; Černá	<a href="http://www.wago.com/216-224">www.wago.com/216-224</a>
	<b>Obj. č.: 216-321</b> Dutinka; Objímka na 0,25 mm <sup>2</sup> / AWG 24; S plastovým límcem; Galvanicky pocínováno; Žlutá	<a href="http://www.wago.com/216-321">www.wago.com/216-321</a>
	<b>Obj. č.: 216-322</b> Ferrule; Sleeve for 0.34 mm <sup>2</sup> / 22 AWG; insulated; electro-tin plated; green	<a href="http://www.wago.com/216-322">www.wago.com/216-322</a>
<b>Insulation stop</b>		
	<b>Obj. č.: 280-470</b> Izolační zarážka; 0,08–0,2 mm <sup>2</sup> „e“ (0,14 mm <sup>2</sup> „f“); 5 ks/pás; Bílá	<a href="http://www.wago.com/280-470">www.wago.com/280-470</a>
	<b>Obj. č.: 280-471</b> Izolační zarážka; 0,25–0,5 mm <sup>2</sup> ; 5 ks/pás; Světle šedá	<a href="http://www.wago.com/280-471">www.wago.com/280-471</a>
	<b>Obj. č.: 280-472</b> Izolační zarážka; 0,75–1 mm <sup>2</sup> ; 5 ks/pás	<a href="http://www.wago.com/280-472">www.wago.com/280-472</a>
<b>End plate</b>		
	<b>Obj. č.: 270-319</b> Koncová bočnice a separátor; Tloušťka 1 mm; Pro třípatrové svorky; Šedá	<a href="http://www.wago.com/270-319">www.wago.com/270-319</a>
	<b>Obj. č.: 270-321</b> Koncová bočnice a separátor; Tloušťka 1 mm; Pro třípatrové svorky; Oranžová	<a href="http://www.wago.com/270-321">www.wago.com/270-321</a>

## Ke stažení

### Documentation

#### Additional Information

Technical explanations	03-Apr-2019	pdf 2,1 MB	Stáhnout
------------------------	-------------	---------------	----------

## CAD/CAE-Data

### CAD data

2D/3D Models 270-572	URL	Stáhnout
----------------------	-----	----------

### CAE data



## Handling Instructions

### Jumpered

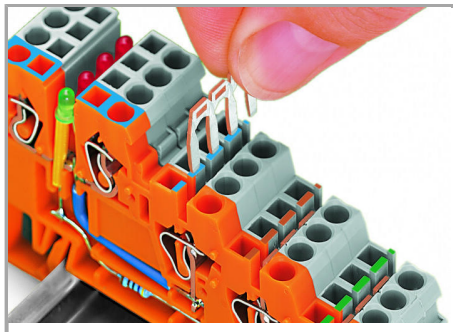

Inserting a jumper.

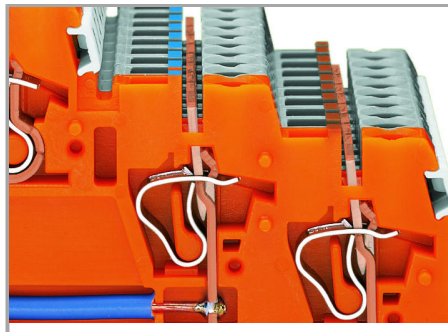

Commoning a supply voltage using uninsulated push-in type jumper bars, 2- to 9-way or 17-way (2 x 8 bits), depending on application.



Commoning signal level voltage via insulated push-in type jumper bars (870 Series) – 2- to 9-way, depending on application.

**Sensor LED terminal blocks cannot be commoned!**

### Marking

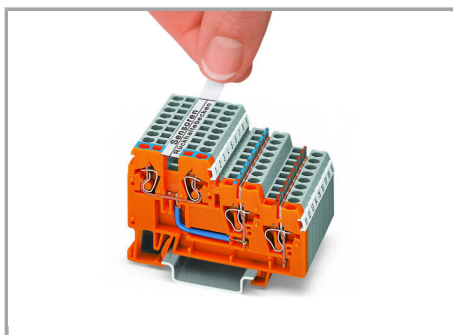

Marking strip (Item No. 709-196)

**Not suitable for LED terminal blocks!**

Změny vyhrazeny.