

Datový list | Objednací číslo: 270-570

4vodičová svorka pro senzor; S barevnými přívody vodiče; 2,5 mm<sup>2</sup>; CAGE CLAMP®; 2,50 mm<sup>2</sup>; Šedá

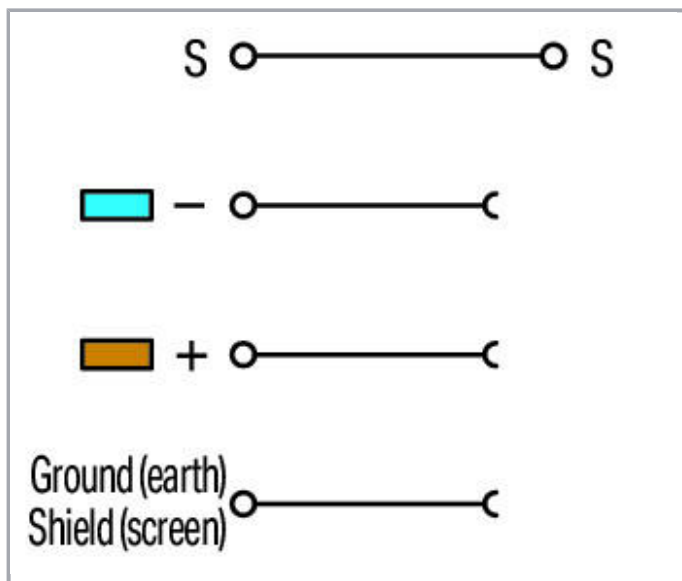

[www.wago.com/270-570](http://www.wago.com/270-570)

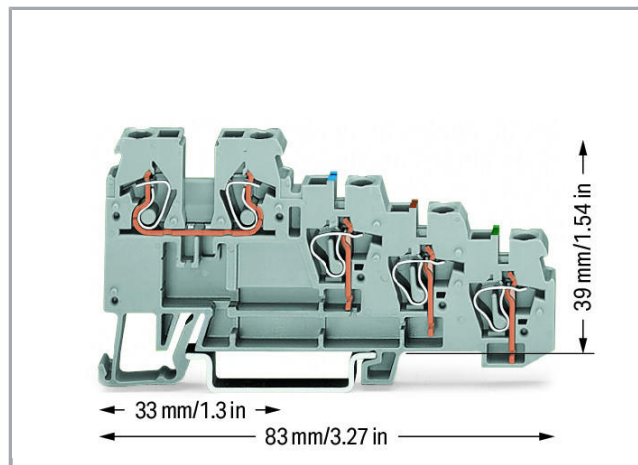
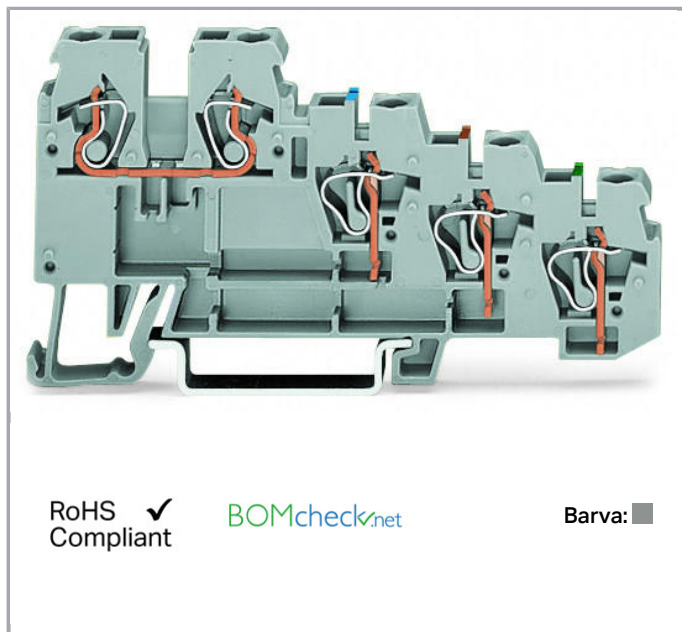

#### Data

Elektrické parametry

#### Ratings per IEC/EN 60664-1

Návrhové napětí (III / 3)	250 V
Návrhové rázové napětí (III / 3)	4 kV



Jmenovitý proud	18 A
Legenda (návrhové hodnoty)	(III / 3) $\hat{=}$ kategorie přepětí III / stupeň znečištění 3

### Údaje o připojení

Připojovací technika	CAGE CLAMP®
Způsob ovládání	Ovládací nástroj
Materiály připojitelných vodičů	Měď
Plný vodič	0,08 ... 2,5 mm <sup>2</sup> / 28 ... 12 AWG
Jemně laněný vodič	0,08 ... 2,5 mm <sup>2</sup> / 28 ... 12 AWG
Délka odizolování	6 ... 7 mm / 0.24 ... 0.28 palec
Celkový počet kontaktních míst	5
Celkový počet potenciálů	4
Počet úrovní	4
Způsob zapojení	čelní připojení
Upozornění (průřez vodiče)	12 AWG: THHN, THWN

### Geometrické údaje

Šířka	5 mm / 0.197 inch
Výška od horní hrany lišty DIN 35	39 mm / 1.535 inch
Hloubka	83 mm / 3.268 inch

### Mechanické parametry

Provedení	Horizontální provedení
Způsob montáže	Lišta DIN 35
Úroveň popisování	Boční popis

### Údaje o materiálu



barva	šedá
Požární zatížení	0.201 MJ
Hmotnost	10.484 g

### Obchodní údaje

Product Group	1 (Rail Mounted Terminal Blocks)
Druh balení	BOX
Country of origin	CN
GTIN	4050821035305
Customs Tariff No.	85369010000

## Atesty/certifikáty

## Specifické atesty jednotlivých států





Logo	Schválení	Doplňkový text schválení	Název certifikátu
	CCA DEKRA Certification B.V.	EN 60947	NTR NL 6828
	CCA DEKRA Certification B.V.	EN 60947	2143311.03
	CSA DEKRA Certification B.V.	C22.2	1565649

## Atesty UL















Logo	Schválení	Doplňkový text schválení	Název certifikátu
	UR Underwriters Laboratories Inc.	UL 1059	20190731- E45172

















## Kompatibilní produkty

## Jumper

	Obj. č.: 270-409 Můstek; Čistý; 9x; Jmenovitý proud 18 A; Stříbrná	<a href="http://www.wago.com/270-409">www.wago.com/270-409</a>
	Obj. č.: 270-417 Můstek; Čistý; 17x; Jmenovitý proud 18 A; Stříbrná	<a href="http://www.wago.com/270-417">www.wago.com/270-417</a>
	Obj. č.: 270-480 Můstek; Čistý; 80x; Jmenovitý proud 18 A; Stříbrná	<a href="http://www.wago.com/270-480">www.wago.com/270-480</a>
	Obj. č.: 870-402 Hřebenový můstek; Izolováno; 2x; Jmenovitý proud 18 A; Světle šedá	<a href="http://www.wago.com/870-402">www.wago.com/870-402</a>
	Obj. č.: 870-403 Hřebenový můstek; Izolováno; 3x; Jmenovitý proud 18 A; Světle šedá	<a href="http://www.wago.com/870-403">www.wago.com/870-403</a>

	<b>Obj. č.: 870-404</b> Push-in type jumper bar; insulated; 4-way; Nominal current 18 A; light gray	<a href="http://www.wago.com/870-404">www.wago.com/870-404</a>
	<b>Obj. č.: 870-405</b> Hřebenový můstek; Izolováno; 5×; Jmenovitý proud 18 A; Světle šedá	<a href="http://www.wago.com/870-405">www.wago.com/870-405</a>
	<b>Obj. č.: 870-405/011-000</b> Ready-made push-in type jumper bar; insulated; 3-way (1-3-5); Nominal current 18 A; light gray	<a href="http://www.wago.com/870-405/011-000">www.wago.com/870-405/011-000</a>
	<b>Obj. č.: 870-406</b> Hřebenový můstek; Izolováno; 6×; Jmenovitý proud 18 A; Světle šedá	<a href="http://www.wago.com/870-406">www.wago.com/870-406</a>
	<b>Obj. č.: 870-407</b> Hřebenový můstek; Izolováno; 7×; Jmenovitý proud 18 A; Světle šedá	<a href="http://www.wago.com/870-407">www.wago.com/870-407</a>
	<b>Obj. č.: 870-407/011-000</b> Ready-made push-in type jumper bar; insulated; 1-3-5-7; Nominal current 18 A; light gray	<a href="http://www.wago.com/870-407/011-000">www.wago.com/870-407/011-000</a>
	<b>Obj. č.: 870-408</b> Hřebenový můstek; Izolováno; 8×; Jmenovitý proud 18 A; Světle šedá	<a href="http://www.wago.com/870-408">www.wago.com/870-408</a>
	<b>Obj. č.: 870-409</b> Hřebenový můstek; Izolováno; 9×; Jmenovitý proud 18 A; Světle šedá	<a href="http://www.wago.com/870-409">www.wago.com/870-409</a>
	<b>Obj. č.: 870-409/011-000</b> Ready-made push-in type jumper bar; insulated; 1-3-5-7-9; Nominal current 18 A; light gray	<a href="http://www.wago.com/870-409/011-000">www.wago.com/870-409/011-000</a>
<b>Marking accessories</b>		
	<b>Obj. č.: 2009-110</b> Popisovací páska; Na cívce; Neflexibilní; Bez potisku; Možnost naklapnutí; Bílá	<a href="http://www.wago.com/2009-110">www.wago.com/2009-110</a>
	<b>Obj. č.: 2009-115</b> WMB Inline; Pro Smart Printer; Na cívce; Flexibilní, 5–5,2 mm; Bez potisku; Možnost naklapnutí; Bílá	<a href="http://www.wago.com/2009-115">www.wago.com/2009-115</a>
	<b>Obj. č.: 2009-115/000-002</b> WMB Inline; Pro Smart Printer; Na cívce; Flexibilní, 5–5,2 mm; Bez potisku; Možnost naklapnutí; Žlutá	<a href="http://www.wago.com/2009-115/000-002">www.wago.com/2009-115/000-002</a>
	<b>Obj. č.: 2009-115/000-006</b> WMB Inline; Pro Smart Printer; Na cívce; Flexibilní, 5–5,2 mm; Bez potisku; Možnost naklapnutí; Modrá	<a href="http://www.wago.com/2009-115/000-006">www.wago.com/2009-115/000-006</a>
	<b>Obj. č.: 2009-115/000-007</b> WMB Inline; Pro Smart Printer; Na cívce; Flexibilní, 5–5,2 mm; Bez potisku; Možnost naklapnutí; Šedá	<a href="http://www.wago.com/2009-115/000-007">www.wago.com/2009-115/000-007</a>
	<b>Obj. č.: 2009-115/000-012</b> WMB Inline; Pro Smart Printer; Na cívce; Flexibilní, 5–5,2 mm; Bez potisku; Možnost naklapnutí; Oranžová	<a href="http://www.wago.com/2009-115/000-012">www.wago.com/2009-115/000-012</a>
	<b>Obj. č.: 2009-115/000-017</b> WMB Inline; Pro Smart Printer; Na cívce; Flexibilní, 5–5,2 mm; Bez potisku; Možnost naklapnutí; Světle zelená	<a href="http://www.wago.com/2009-115/000-017">www.wago.com/2009-115/000-017</a>
	<b>Obj. č.: 2009-115/000-023</b>	

	WMB Inline; Pro Smart Printer; Na cívce; Flexibilní, 5–5,2 mm; Bez potisku; Možnost naklapnutí; Zelená	<a href="http://www.wago.com/2009-115/000-023">www.wago.com/2009-115/000-023</a>
	<b>Obj. č.: 2009-115/000-024</b> WMB Inline; Pro Smart Printer; Na cívce; Flexibilní, 5–5,2 mm; Bez potisku; Možnost naklapnutí; Fialová	<a href="http://www.wago.com/2009-115/000-024">www.wago.com/2009-115/000-024</a>
	<b>Obj. č.: 2009-145</b> Mini-WSB Inline; Pro Smart Printer; Na cívce; Flexibilní, 5–5,2 mm; Bez potisku; Možnost naklapnutí; Bílá	<a href="http://www.wago.com/2009-145">www.wago.com/2009-145</a>
	<b>Obj. č.: 2009-145/000-002</b> Mini-WSB Inline; Pro Smart Printer; Na cívce; Flexibilní, 5–5,2 mm; Bez potisku; Možnost naklapnutí; Žlutá	<a href="http://www.wago.com/2009-145/000-002">www.wago.com/2009-145/000-002</a>
	<b>Obj. č.: 2009-145/000-005</b> Mini-WSB Inline; Pro Smart Printer; Na cívce; Flexibilní, 5–5,2 mm; Bez potisku; Možnost naklapnutí; Červená	<a href="http://www.wago.com/2009-145/000-005">www.wago.com/2009-145/000-005</a>
	<b>Obj. č.: 2009-145/000-006</b> Mini-WSB Inline; Pro Smart Printer; Na cívce; Flexibilní, 5–5,2 mm; Bez potisku; Možnost naklapnutí; Modrá	<a href="http://www.wago.com/2009-145/000-006">www.wago.com/2009-145/000-006</a>
	<b>Obj. č.: 2009-145/000-007</b> Mini-WSB Inline; Pro Smart Printer; Na cívce; Flexibilní, 5–5,2 mm; Bez potisku; Možnost naklapnutí; Šedá	<a href="http://www.wago.com/2009-145/000-007">www.wago.com/2009-145/000-007</a>
	<b>Obj. č.: 2009-145/000-012</b> Mini-WSB Inline; Pro Smart Printer; Na cívce; Flexibilní, 5–5,2 mm; Bez potisku; Možnost naklapnutí; Oranžová	<a href="http://www.wago.com/2009-145/000-012">www.wago.com/2009-145/000-012</a>
	<b>Obj. č.: 2009-145/000-023</b> Mini-WSB Inline; Pro Smart Printer; Na cívce; Flexibilní, 5–5,2 mm; Bez potisku; Možnost naklapnutí; Zelená	<a href="http://www.wago.com/2009-145/000-023">www.wago.com/2009-145/000-023</a>
	<b>Obj. č.: 2009-145/000-024</b> Mini-WSB Inline; Pro Smart Printer; Na cívce; Flexibilní, 5–5,2 mm; Bez potisku; Možnost naklapnutí; Fialová	<a href="http://www.wago.com/2009-145/000-024">www.wago.com/2009-145/000-024</a>
	<b>Obj. č.: 248-501</b> Systém rychlého popisování Mini-WSB; Bez potisku; Šířka štítků 5 mm; 10 řad po 10 štítcích na každé kartě	<a href="http://www.wago.com/248-501">www.wago.com/248-501</a>
	<b>Obj. č.: 248-501/000-002</b> Popisovací karta Mini-WSB; Jako karta; Neflexibilní; Bez potisku; Možnost naklapnutí; Žlutá	<a href="http://www.wago.com/248-501/000-002">www.wago.com/248-501/000-002</a>
	<b>Obj. č.: 248-501/000-005</b> Popisovací karta Mini-WSB; Jako karta; Neflexibilní; Bez potisku; Možnost naklapnutí; Červená	<a href="http://www.wago.com/248-501/000-005">www.wago.com/248-501/000-005</a>
	<b>Obj. č.: 248-501/000-006</b> Popisovací karta Mini-WSB; Jako karta; Neflexibilní; Bez potisku; Možnost naklapnutí; Modrá	<a href="http://www.wago.com/248-501/000-006">www.wago.com/248-501/000-006</a>
	<b>Obj. č.: 248-501/000-007</b> Popisovací karta Mini-WSB; Jako karta; Neflexibilní; Bez potisku; Možnost naklapnutí; Šedá	<a href="http://www.wago.com/248-501/000-007">www.wago.com/248-501/000-007</a>

	<b>Obj. č.: 248-501/000-012</b> Popisovací karta Mini-WSB; Jako karta; Neflexibilní; Bez potisku; Možnost naklapnutí; Oranžová	<a href="http://www.wago.com/248-501/000-012">www.wago.com/248-501/000-012</a>
	<b>Obj. č.: 248-501/000-017</b> Popisovací karta Mini-WSB; Jako karta; Neflexibilní; Bez potisku; Možnost naklapnutí; Světle zelená	<a href="http://www.wago.com/248-501/000-017">www.wago.com/248-501/000-017</a>
	<b>Obj. č.: 248-501/000-023</b> Popisovací karta Mini-WSB; Jako karta; Neflexibilní; Bez potisku; Možnost naklapnutí; Zelená	<a href="http://www.wago.com/248-501/000-023">www.wago.com/248-501/000-023</a>
	<b>Obj. č.: 248-501/000-024</b> Popisovací karta Mini-WSB; Jako karta; Neflexibilní; Bez potisku; Možnost naklapnutí; Fialová	<a href="http://www.wago.com/248-501/000-024">www.wago.com/248-501/000-024</a>
	<b>Obj. č.: 709-177</b> Popisovací páska; Na cívce; Šířka 7,5 mm; Neflexibilní; Bez potisku; Možnost naklapnutí; Průsvitná	<a href="http://www.wago.com/709-177">www.wago.com/709-177</a>
	<b>Obj. č.: 709-178</b> Popisovací páska; Na cívce; Šířka 7,5 mm; Neflexibilní; Bez potisku; Možnost naklapnutí; Bílá	<a href="http://www.wago.com/709-178">www.wago.com/709-178</a>
	<b>Obj. č.: 709-196</b> Popisovací páska; Pro laserové tiskárny; Průsvitná	<a href="http://www.wago.com/709-196">www.wago.com/709-196</a>
	<b>Obj. č.: 709-198</b> Popisovací páska; Bílá	<a href="http://www.wago.com/709-198">www.wago.com/709-198</a>
	<b>Obj. č.: 793-501</b> Popisovací karta WMB; Jako karta; Neflexibilní; Bez potisku; Možnost naklapnutí; Bílá	<a href="http://www.wago.com/793-501">www.wago.com/793-501</a>
	<b>Obj. č.: 793-501/000-002</b> Popisovací karta WMB; Jako karta; Neflexibilní; Bez potisku; Možnost naklapnutí; Bílá	<a href="http://www.wago.com/793-501/000-002">www.wago.com/793-501/000-002</a>
	<b>Obj. č.: 793-501/000-005</b> Popisovací karta WMB; Jako karta; Neflexibilní; Bez potisku; Možnost naklapnutí; Červená	<a href="http://www.wago.com/793-501/000-005">www.wago.com/793-501/000-005</a>
	<b>Obj. č.: 793-501/000-006</b> Popisovací karta WMB; Jako karta; Neflexibilní; Bez potisku; Možnost naklapnutí; Modrá	<a href="http://www.wago.com/793-501/000-006">www.wago.com/793-501/000-006</a>
	<b>Obj. č.: 793-501/000-007</b> Popisovací karta WMB; Jako karta; Neflexibilní; Bez potisku; Možnost naklapnutí; Šedá	<a href="http://www.wago.com/793-501/000-007">www.wago.com/793-501/000-007</a>
	<b>Obj. č.: 793-501/000-012</b> Popisovací karta WMB; Jako karta; Neflexibilní; Bez potisku; Možnost naklapnutí; Oranžová	<a href="http://www.wago.com/793-501/000-012">www.wago.com/793-501/000-012</a>
	<b>Obj. č.: 793-501/000-017</b> Popisovací karta WMB; Jako karta; Neflexibilní; Bez potisku; Možnost naklapnutí; Světle zelená	<a href="http://www.wago.com/793-501/000-017">www.wago.com/793-501/000-017</a>
	<b>Obj. č.: 793-501/000-023</b> Popisovací karta WMB; Jako karta; Neflexibilní; Bez potisku; Možnost naklapnutí; Zelená	<a href="http://www.wago.com/793-501/000-023">www.wago.com/793-501/000-023</a>



Obj. č.: 793-501/000-024

Popisovací karta WMB; Jako karta; Neflexibilní; Bez potisku; Možnost naklapnutí; Fialová

[www.wago.com/793-501/000-024](http://www.wago.com/793-501/000-024)

Obj. č.: 793-5501

Popisovací karta WMB; Jako karta; Pro svorky o šířce 5–17,5 mm; Flexibilní, 5–5,2 mm; Bez potisku; Možnost naklapnutí; Bílá

[www.wago.com/793-5501](http://www.wago.com/793-5501)

Obj. č.: 793-5501/000-002

Popisovací karta WMB; Jako karta; Pro svorky o šířce 5–17,5 mm; Flexibilní, 5–5,2 mm; Bez potisku; Možnost naklapnutí; Žlutá

[www.wago.com/793-5501/000-002](http://www.wago.com/793-5501/000-002)

Obj. č.: 793-5501/000-005

Popisovací karta WMB; Jako karta; Flexibilní, 5–5,2 mm; Bez potisku; Možnost naklapnutí; Červená

[www.wago.com/793-5501/000-005](http://www.wago.com/793-5501/000-005)

Obj. č.: 793-5501/000-006

Popisovací karta WMB; Jako karta; Flexibilní, 5–5,2 mm; Bez potisku; Možnost naklapnutí; Modrá

[www.wago.com/793-5501/000-006](http://www.wago.com/793-5501/000-006)

Obj. č.: 793-5501/000-007

Popisovací karta WMB; Jako karta; Flexibilní, 5–5,2 mm; Bez potisku; Možnost naklapnutí; Šedá

[www.wago.com/793-5501/000-007](http://www.wago.com/793-5501/000-007)

Obj. č.: 793-5501/000-012

Popisovací karta WMB; Jako karta; Flexibilní, 5–5,2 mm; Bez potisku; Možnost naklapnutí; Oranžová

[www.wago.com/793-5501/000-012](http://www.wago.com/793-5501/000-012)

Obj. č.: 793-5501/000-017

Popisovací karta WMB; Jako karta; Flexibilní, 5–5,2 mm; Bez potisku; Možnost naklapnutí; Světle zelená

[www.wago.com/793-5501/000-017](http://www.wago.com/793-5501/000-017)

Obj. č.: 793-5501/000-023

Popisovací karta WMB; Jako karta; Flexibilní, 5–5,2 mm; Bez potisku; Možnost naklapnutí; Zelená

[www.wago.com/793-5501/000-023](http://www.wago.com/793-5501/000-023)

Obj. č.: 793-5501/000-024

Popisovací karta WMB; Jako karta; Flexibilní, 5–5,2 mm; Bez potisku; Možnost naklapnutí; Fialová

[www.wago.com/793-5501/000-024](http://www.wago.com/793-5501/000-024)

#### End plate



Obj. č.: 270-320

Koncová bočnice a separátor; Tloušťka 1 mm; Pro čtyřpatrové svorky; Šedá

[www.wago.com/270-320](http://www.wago.com/270-320)

Obj. č.: 270-322

Koncová bočnice a separátor; Tloušťka 1 mm; Pro čtyřpatrové svorky; Oranžová

[www.wago.com/270-322](http://www.wago.com/270-322)

#### ferrule



Obj. č.: 216-121

Dutinka; Objímka na 0,5 mm<sup>2</sup> / AWG 22; Bez plastového límce; Galvanicky pocínováno[www.wago.com/216-121](http://www.wago.com/216-121)

Obj. č.: 216-122













Dutinka; Objímka na 0,75 mm<sup>2</sup> / AWG 20; Bez plastového límce; Galvanicky pocínováno[www.wago.com/216-122](http://www.wago.com/216-122)

Obj. č.: 216-123

Dutinka; Objímka na 1 mm<sup>2</sup> / AWG 18; Bez plastového límce; Galvanicky pocínováno[www.wago.com/216-123](http://www.wago.com/216-123)

Obj. č.: 216-124

Dutinka; Objímka na 1,5 mm<sup>2</sup> / AWG 16; Bez plastového límce; Galvanicky pocínováno[www.wago.com/216-124](http://www.wago.com/216-124)

	<b>Obj. č.: 216-131</b> Dutinka; Objímka na 0,25 mm <sup>2</sup> / AWG 24; Bez plastového límce; Galvanicky pocínováno	<a href="http://www.wago.com/216-131">www.wago.com/216-131</a>
	<b>Obj. č.: 216-132</b> Dutinka; Objímka na 0,34 mm <sup>2</sup> / AWG 24; Bez plastového límce; Galvanicky pocínováno	<a href="http://www.wago.com/216-132">www.wago.com/216-132</a>
	<b>Obj. č.: 216-221</b> Ferrule; Sleeve for 0.5 mm <sup>2</sup> / 20 AWG; insulated; electro-tin plated; white	<a href="http://www.wago.com/216-221">www.wago.com/216-221</a>
	<b>Obj. č.: 216-222</b> Ferrule; Sleeve for 0.75 mm <sup>2</sup> / 18 AWG; insulated; electro-tin plated; gray	<a href="http://www.wago.com/216-222">www.wago.com/216-222</a>
	<b>Obj. č.: 216-223</b> Dutinka; Objímka na 1 mm <sup>2</sup> / AWG 18; S plastovým límcem; Galvanicky pocínováno; Červená	<a href="http://www.wago.com/216-223">www.wago.com/216-223</a>
	<b>Obj. č.: 216-224</b> Dutinka; Objímka na 1,5 mm <sup>2</sup> / AWG 16; S plastovým límcem; Galvanicky pocínováno; Černá	<a href="http://www.wago.com/216-224">www.wago.com/216-224</a>
	<b>Obj. č.: 216-321</b> Dutinka; Objímka na 0,25 mm <sup>2</sup> / AWG 24; S plastovým límcem; Galvanicky pocínováno; Žlutá	<a href="http://www.wago.com/216-321">www.wago.com/216-321</a>
	<b>Obj. č.: 216-322</b> Ferrule; Sleeve for 0.34 mm <sup>2</sup> / 22 AWG; insulated; electro-tin plated; green	<a href="http://www.wago.com/216-322">www.wago.com/216-322</a>
<b>Insulation stop</b>		
	<b>Obj. č.: 280-470</b> Izolační zarážka; 0,08–0,2 mm <sup>2</sup> „e“ (0,14 mm <sup>2</sup> „f“); 5 ks/pás; Bílá	<a href="http://www.wago.com/280-470">www.wago.com/280-470</a>
	<b>Obj. č.: 280-471</b> Izolační zarážka; 0,25–0,5 mm <sup>2</sup> ; 5 ks/pás; Světle šedá	<a href="http://www.wago.com/280-471">www.wago.com/280-471</a>
	<b>Obj. č.: 280-472</b> Izolační zarážka; 0,75–1 mm <sup>2</sup> ; 5 ks/pás	<a href="http://www.wago.com/280-472">www.wago.com/280-472</a>
<b>tools</b>		
	<b>Obj. č.: 210-657</b> Ovládací nástroj; Břit: 3,5 × 0,5 mm; S částečně izolovanou rukojetí; Krátké	<a href="http://www.wago.com/210-657">www.wago.com/210-657</a>
	<b>Obj. č.: 210-720</b> Ovládací nástroj; Břit: 3,5 × 0,5 mm; S částečně izolovanou rukojetí	<a href="http://www.wago.com/210-720">www.wago.com/210-720</a>

## Ke stažení

### Documentation

#### Additional Information

Technical explanations	03-Apr-2019	pdf 2,1 MB	Stáhnout
------------------------	-------------	---------------	----------

### CAD/CAE-Data

#### CAD data

2D/3D Models 270-570	URL	Stáhnout
----------------------	-----	----------



## CAE data

EPLAN Data Portal 270-570

Stáhnout

WSCAD Universe 270-570

Stáhnout

## Handling Instructions

### Jumpered

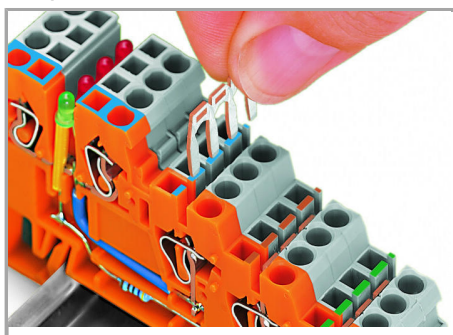

Inserting a jumper.

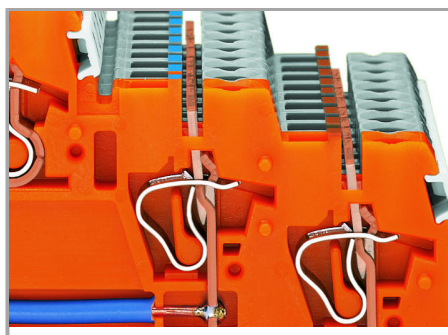

Commoning a supply voltage using uninsulated push-in type jumper bars, 2- to 9-way or 17-way (2 x 8 bits), depending on application.



Commoning signal level voltage via insulated push-in type jumper bars (870 Series) – 2- to 9-way, depending on application.

**Sensor LED terminal blocks cannot be commoned!**

### Marking

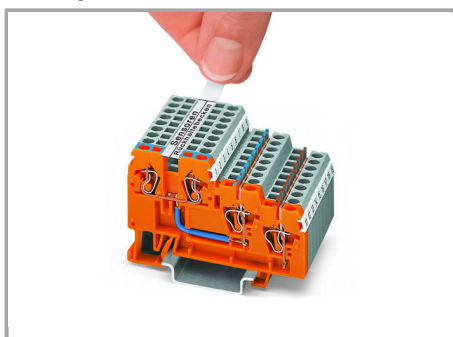

Marking strip (Item No. 709-196)

**Not suitable for LED terminal blocks!**

Změny vyhrazeny.

WAGO Elektro spol. sr. o.  
Rozvodova 1116/36  
143 00 Praha 12 - Modřany  
Tel.: +420 261 090 143  
Email: [info.cz@wago.com](mailto:info.cz@wago.com), [wago-cz@wago.com](mailto:wago-cz@wago.com)

Máte otázky ohledně našich produktů?  
Kdykoli nám zavolejte na číslo +420 261 090 143.