

KT label sleeve (standard sleeve)

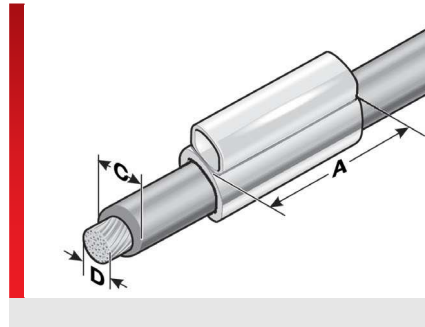

Single wire, cable, and conduit labelling

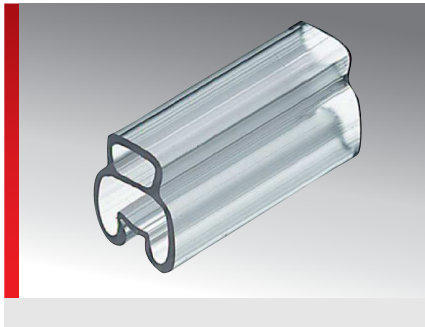



PRODUCT INFORMATION

High-quality, fully transparent label sleeves for labelling wires, cables and conduits. The KT label sleeves hold the BK idents and type KS labels.

- 7 sizes are available for wire cross sections from 0.22 – 120 mm².
- The sleeves come in different lengths.

The KT 2/20x9 as well as KT 2/35x9 for multi-line inscription are designed to hold type KSO labels.

SPECIFICATIONS

-  Polyvinyl chloride (PVC)
-  -40 – 60 °C
-  V0
-  Standard label sleeve
- 

Type	Order No.	Area of application from - to Ø mm (C)	Wire cross section from - to mm ² (D)	Recommended Label plate	No. idents BK23 / BK30	Pack qty.
10 mm sleeve length (A), single line inscription						
KT 0/10	86201010	1.30 – 2.00	0.22 – 0.50	KS 4/10	4 / 3	2000
KT 1/10	86201012	1.80 – 2.50	0.50 – 1.00	KS 4/10	4 / 3	2000
KT 2/10	86201014	2.50 – 4.00	0.75 – 2.50	KS 4/10	4 / 3	2000
KT 3/10	86201016	4.00 – 6.50	2.50 – 6.00	KS 4/10	4 / 3	1000
KT 4/10	86201018	6.00 – 10.00	10.00 – 25.00	KS 4/10	4 / 3	1000
KT 5/10	86201020	9.00 – 15.00	25.00 – 50.00	KS 4/10	4 / 3	1000
KT 6/10	86201022	15.00 – 23.00	50.00 – 120.00	KS 4/10	4 / 3	500
12 mm sleeve length (A), single line inscription						
KT 0/12	86201210	1.30 – 2.00	0.22 – 0.50	KS 4/12	5 / 4	2000
KT 1/12	86201212	1.80 – 2.50	0.50 – 1.00	KS 4/12	5 / 4	2000
KT 2/12	86201214	2.50 – 4.00	0.75 – 2.50	KS 4/12	5 / 4	2000
KT 3/12	86201216	4.00 – 6.50	2.50 – 6.00	KS 4/12	5 / 4	1000
KT 4/12	86201218	6.00 – 10.00	10.00 – 25.00	KS 4/12	5 / 4	1000
KT 5/12	86201220	9.00 – 15.00	25.00 – 50.00	KS 4/12	5 / 4	1000
KT 6/12	86201222	15.00 – 23.00	50.00 – 120.00	KS 4/12	5 / 4	500
15 mm sleeve length (A), single line inscription						
KT 0/15	86201510	1.30 – 2.00	0.22 – 0.50	KS 4/15	6 / 5	2000
KT 1/15	86201512	1.80 – 2.50	0.50 – 1.00	KS 4/15	6 / 5	2000
KT 2/15	86201514	2.50 – 4.00	0.75 – 2.50	KS 4/15	6 / 5	2000
KT 3/15	86201516	4.00 – 6.50	2.50 – 6.00	KS 4/15	6 / 5	1000
KT 4/15	86201518	6.00 – 10.00	10.00 – 25.00	KS 4/15	6 / 5	1000
KT 5/15	86201520	9.00 – 15.00	25.00 – 50.00	KS 4/15	6 / 5	1000

KT label sleeve (standard sleeve)

Type	Order No.	Area of application from - to Ø mm (C)	Wire cross section from - to mm ² (D)	Recommended Label plate	No. idents BK23 / BK30	Pack qty.
KT 6/15	86201522	15.00 – 23.00	50.00 – 120.00	KS 4/15	6 / 5	500
18 mm sleeve length (A), single line inscription						
KT 0/18	86201810	1.30 – 2.00	0.22 – 0.50	KS 4/18	7 / 6	2000
KT 1/18	86201812	1.80 – 2.50	0.50 – 1.00	KS 4/18	7 / 6	2000
KT 2/18	86201814	2.50 – 4.00	0.75 – 2.50	KS 4/18	7 / 6	2000
KT 3/18	86201816	4.00 – 6.50	2.50 – 6.00	KS 4/18	7 / 6	1000
KT 4/18	86201818	6.00 – 10.00	10.00 – 25.00	KS 4/18	7 / 6	1000
KT 5/18	86201820	9.00 – 15.00	25.00 – 50.00	KS 4/18	7 / 6	750
KT 6/18	86201822	15.00 – 23.00	50.00 – 120.00	KS 4/18	7 / 6	300
23 mm sleeve length (A), single line inscription						
KT 0/23	86202310	1.30 – 2.00	0.22 – 0.50	KS 4/23	10 / 7	2000
KT 1/23	86202312	1.80 – 2.50	0.50 – 1.00	KS 4/23	10 / 7	2000
KT 2/23	86202314	2.50 – 4.00	0.75 – 2.50	KS 4/23	10 / 7	1000
KT 3/23	86202316	4.00 – 6.50	2.50 – 6.00	KS 4/23	10 / 7	1000
KT 4/23	86202318	6.00 – 10.00	10.00 – 25.00	KS 4/23	10 / 7	1000
KT 5/23	86202320	9.00 – 15.00	25.00 – 50.00	KS 4/23	10 / 7	500
KT 6/23	86202322	15.00 – 23.00	50.00 – 120.00	KS 4/23	10 / 7	250
30 mm sleeve length (A), single line inscription						
KT 0/30	86203010	1.30 – 2.00	0.22 – 0.50	KS 4/30	13 / 10	1000
KT 1/30	86203012	1.80 – 2.50	0.50 – 1.00	KS 4/30	13 / 10	1500
KT 2/30	86203014	2.50 – 4.00	0.75 – 2.50	KS 4/30	13 / 10	1000
KT 3/30	86203016	4.00 – 6.50	2.50 – 6.00	KS 4/30	13 / 10	1000
KT 4/30	86203018	6.00 – 10.00	10.00 – 25.00	KS 4/30	13 / 10	500
KT 5/30	86203020	9.00 – 15.00	25.00 – 50.00	KS 4/30	13 / 10	500
KT 6/30	86203022	15.00 – 23.00	50.00 – 120.00	KS 4/30	13 / 10	200
20 mm sleeve length (A), single and multi-line inscription						
KT 2/20x9	86202050	2.50 – 4.00	0.75 – 2.50	KSO 20x9		1000
35 mm sleeve length (A), single and multi-line inscription						
KT 2/35x9	86203550	2.50 – 4.00	0.75 – 2.50	KSO 35x9		500
70 mm sleeve length (A), single line inscription						
KT 2/70	86207014	2.50 – 4.00	0.75 – 2.50	KS 4/30-70	30 / 23	500
KT 3/70	86207016	4.00 – 6.50	2.50 – 6.00	KS 4/30-70	30 / 23	400
* Single wire, type H05/07V-K						

MATERIAL PROPERTIES



Polyvinyl chloride (PVC)

Single wire, cable, and conduit labelling

KT label sleeve (standard sleeve)

THERMAL PROPERTIES



Temperature / temperature range

-40 – 60 °C

FIRE BEHAVIOUR



Fire classification

V0

GENERAL TECHNICAL DATA



Standard label sleeve

INSTALLATION METHOD



Sleeve system

All details given in our sales brochures and catalogues, as well as the information available online, are based on our current knowledge of the products described.

The electronic data and files made available by Murrplastik, particularly CAD files are based on our current knowledge of the product described.

A legally binding assurance of certain properties or the suitability for a certain purpose can not be determined from this information.

All information with respect to the chemical and physical properties of Murrplastik products, as well as application advice given verbally, in writing or by tests, is given to the best of our knowledge.

This does not free the purchaser of carrying out their own inspections and tests in order to determine the suitability of a product for a specific purpose.

Murrplastik accepts no responsibility for the available information being up-to-date, correct or complete. Neither do we accept responsibility for the quality of this information.

Murrplastik accepts no liability for damage caused as a result of using our products.

Murrplastik reserves the right to make technical changes and improvements through constant further development of products and services.

Our General Terms and Conditions apply.