

7 521 65, 7 522 65, 7 523 65,  
7 556 37 / 38 / 39

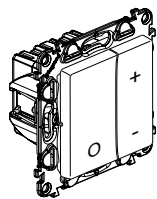









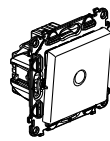



7 521 62, 7 522 62, 7 523 62,  
7 556 34 / 35 / 36

<p><b>ES</b> <b>Consignas de seguridad</b> El no cumplimiento estricto de las instrucciones de instalación y uso puede implicar riesgos de choque eléctrico o incendio.</p> <p><b>PT</b> <b>Instruções de segurança</b> Não respeitar estritamente as condições de instalação e de utilização poderá provocar riscos de choque eléctrico ou de incêndio.</p> <p><b>DE</b> <b>Sicherheitshinweise</b> Bei Nichtbeachtung der Einbaubund Nutzungsvorschriften besteht Stromschlag- bzw. Brandgefahr.</p> <p><b>GR-CY</b> <b>Σημαντικές οδηγίες</b> Η μη αυστηρή τήρηση των συνθηκών εγκατάστασης και χρήσης μπορεί να επιφέρει κινδύνους ηλεκτροπληξίας ή πυρκαγιάς.</p> <p><b>PL</b> <b>Przepisy bezpieczeństwa</b> Niezastosowanie się ściśle do warunków instalacji i użytkowania może grozić porażeniem prądem lub pożarem.</p> <p><b>CZ</b> <b>Bezpečnostní pokyny</b> Nedodržení stanovených podmínek instalace a používání může vést k rizikům zasažení elektrickým proudem nebo požáru.</p> <p><b>SK</b> <b>Bezpečnostné pokyny</b> V prípade nedodržania presných podmienok týkajúcich sa inštalácie a používania hrozí riziko úrazu elektrickým prúdom alebo vzniku požiaru.</p> <p><b>HU</b> <b>Biztonsági előírások</b> A beépítéskor és használatkor feltétlenül szigorú betartásának elmulasztása áramütés vagy tűz kockázatával jár.</p>	<p><b>RO</b> <b>Instrucțiuni de siguranță</b> Nerespectarea strictă a condițiilor de instalare și utilizare poate genera riscuri de șocuri electrice sau incendiu.</p> <p><b>SI</b> <b>Varnostna navodila</b> Neupoštevanje vseh pogojev instalacije in uporabe lahko povzroči nevarnost električnega udara ali požara.</p> <p><b>HR</b> <b>Sigurnosne napomene</b> Ako se ne pridržavate strogo uvjeta za instalaciju i uporabu, može doći do strujnog udara ili požara.</p> <p><b>BG</b> <b>Указания за безопасност</b> Неспазването стриктно на указанията за съгласване и използване може да доведе до риск от токов удар или пожар.</p> <p><b>RS</b> <b>Sigurnosne preporuke</b> Ukoliko se ne pridržavate striktno uslova instaliranja i korišćenja, može doći dostrujnog udara ili požara.</p> <p><b>FR-LU-BE-CH</b> <b>Consignes de sécurité</b> Ne pas respecter strictement les conditions d'installation et d'utilisation peut entraîner des risques de choc électrique ou d'incendie.</p> <p><b>NL-BE</b> <b>Veiligheidsvoorschriften</b> Door de installatie- en gebruiksvoorwaarden niet strikt na te leven, kan er gevaar voor elektrische schokken of brand ontstaan.</p> <p><b>GB-IE</b> <b>Safety instructions</b> The instructions for installation and use must be strictly observed in order to avoid the risk of electric shock or fire.</p>
---	--

<p><b>N</b></p> <p>Neutro = azul Neutralleiter = blau Neutro = azul Ουδέτερος = μπλε Neutralny = niebieski Střední vodič = modrá Nulový vodič = modrá Nulla vezeték = kék Neutro = albastru Nížeňi vodič = modrá Неутрална = синьо Нути проводник = плава Null = plava Neutre = bleu Nullleiter = blauw Neutral = blue</p>	<p><b>L</b></p> <p>Fase = todos excepto azul e verde/amarelo Aussenleiter = aller außer blau und grün/gelb Fase = todos excepto azul y verde/amarillo Φάση = όλα εκτός από μπλε και πράσινο/κίτρινο Fazowy = inny niż niebieski i zielono-żółty Fázový vodič = všechny mimo modré a žlutozelené Фаза = kторékolvek okrem modrá a zelená/žltá Fázis = mind, kivéve a zöld/sárga és kék Фаза = оцсаре, су ексепта албаstrу и galben/verde Fazi vodičnik = katerakoli, razen modre in zeleno/rumene Фаза = всімко освен синьо, зелено/жълто Fazni provodnik = sve osim plave i zelene/žute boje Faza = sve osim plave i zelene/žute Phase = tout sauf bleu et vert/jaune Fase = alles behalve blauw en groen/geel Phase = all, except blue and green/yellow</p>	<p><b>Terra = verde/amarelo</b> Schutzleiter = grün/gelb Tierra = verde/amarillo Γειωση = Πράσινο/Κίτρινο Uziemienie = zielony-żółty Zemnični vodič = zelená/žltá Uzemnienie = zelená/žltá Föld = zöld/sárga Impământare = verde/galben Ozemljitveni vodnik = zelena/rumena Земля = зелено/жълто Uzemljenje = zelena/žuta Zemlja = zelena/žuta Terre = vert/jaune Aarding = groen/geel Earth = green/yellow</p>
--	--	---

7 521 65, 7 522 65, 7 523 65,  
7 556 37 / 38 / 39

	 -20°C ... +70°C	 00:10:00	 8 mm 1,5 mm²	<b>R</b>  	<b>L</b>  	<b>C/L</b>  	 LED														
	 -5°C ... +45°C	<table border="1" style="width: 100%; border-collapse: collapse;"> <tr> <td style="width: 10%;"></td> <td style="width: 10%;">Max.</td> <td style="width: 10%;">150 W</td> <td style="width: 10%;">150 W</td> <td style="width: 10%;">150 VA</td> <td style="width: 10%;">150 VA</td> <td style="width: 10%;">100VA</td> <td style="width: 10%;">650 mA</td> <td style="width: 10%;">650 mA</td> </tr> <tr> <td></td> <td>Min.</td> <td>12 W</td> <td>12 W</td> <td>12 VA</td> <td>12 VA</td> <td>12 VA</td> <td>50 mA</td> <td>50 mA</td> </tr> </table>		Max.	150 W	150 W	150 VA	150 VA	100VA	650 mA	650 mA		Min.	12 W	12 W	12 VA	12 VA	12 VA	50 mA	50 mA	
	Max.	150 W	150 W	150 VA	150 VA	100VA	650 mA	650 mA													
	Min.	12 W	12 W	12 VA	12 VA	12 VA	50 mA	50 mA													

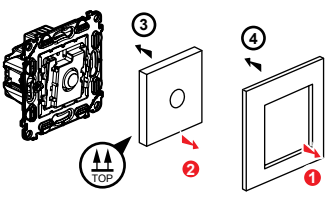

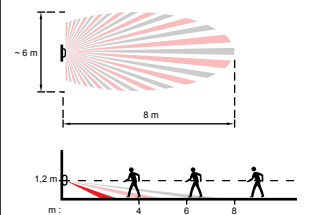

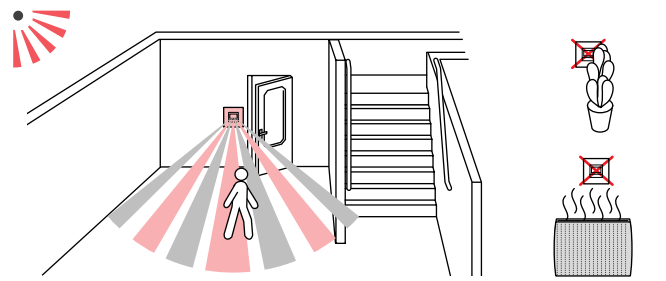
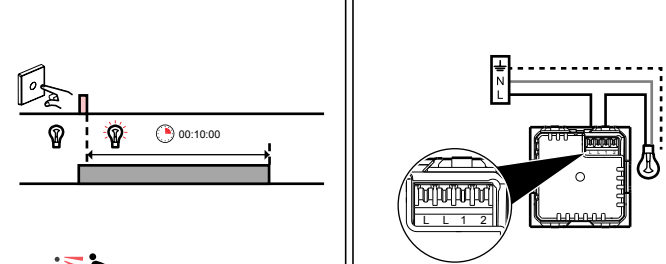
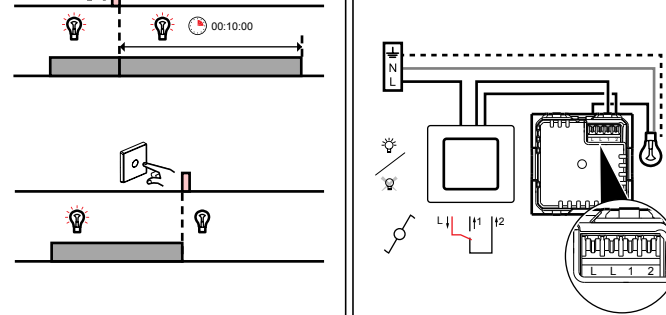
7 521 62, 7 522 62, 7 523 62,  
7 556 34 / 35 / 36

	-10°C ... +75°C	0°C ... +35°C	40 mm	100 ... 240 V~ 50 / 60 Hz	8 mm 1...2.5 mm <sup>2</sup>

	R	L	GL		Dimmable	Dimmable LED
	240V~ 50Hz	3 ... 400 W 400 VA	3 ... 400 VA	3 ... 200 VA	3 ... 200 VA	3 ... 75 W <= 10 x
	100V~ 60Hz	3 ... 200 W 200 VA	3 ... 200 VA	3 ... 100 VA	3 ... 200 VA	3 ... 37 W <= 10 x

