

- **Cassette obturatrice**
- **Afsluitcassette**
- **Blanking cassette**

- **Abdeckkassette**
- **Cassette obturador**
- **Cassete de obturação**

- **Κασέτα στεγάνωσης**
- **Κασετα-ζαγλυσκα**
- **Casseta di copertura**

- **端口封板**
- **كاسيت سدادة**

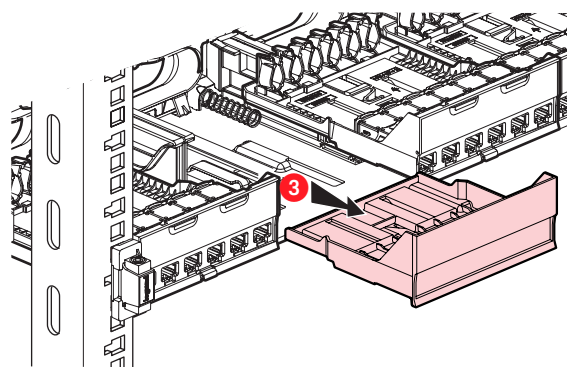
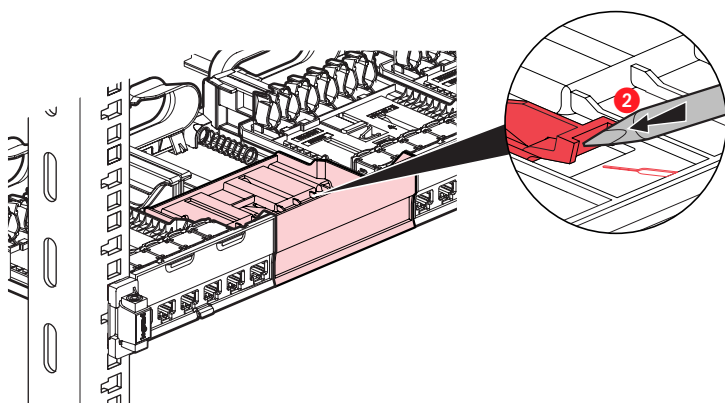
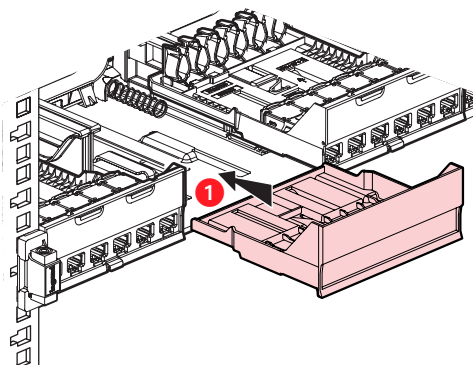

- **Obturateur de ports**
- **Afsluitdop poorten**
- **Port blanking piece**

- **Portabdeckung**
- **Obturador de puertos**
- **Obturador de portas**

- **Τάπες θυρών**
- **Ζαγλυσκα πορτοβ**
- **Copri porta**

- **端口挡片**
- **سدادة المنافذ**

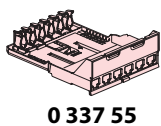

0 337 55

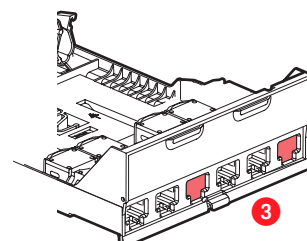
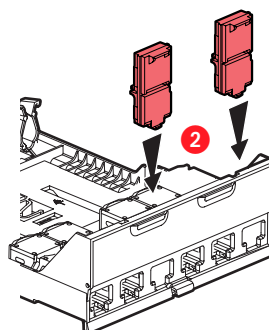
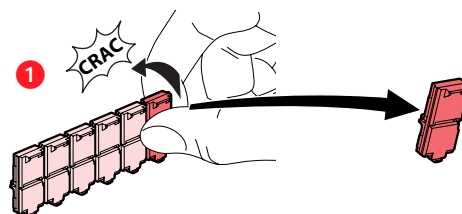
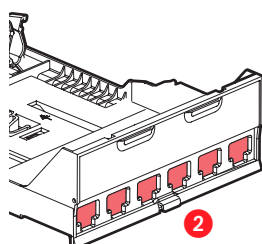
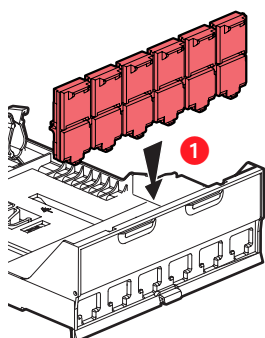

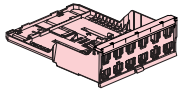

0 337 95

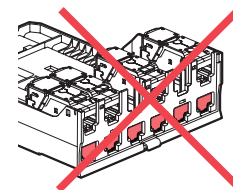
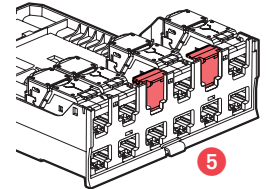
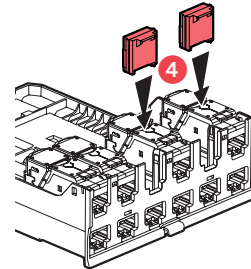
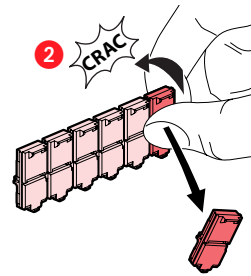
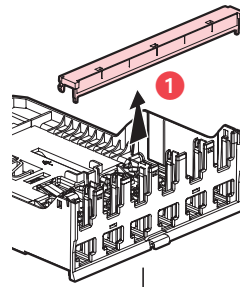
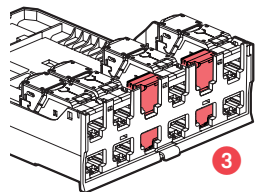
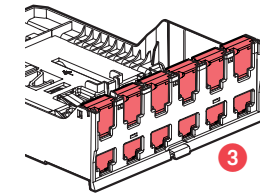
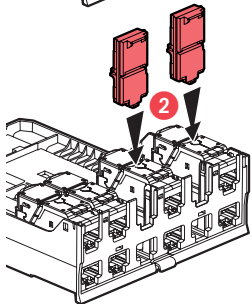
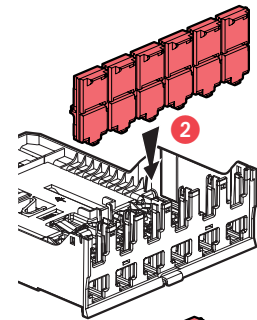

- Accessoire de gestion
- Accessoire voor beheer
- Management accessory

- Verwaltungszubehör
- Accesorio de gestión
- Acessório de gestão

- Αξεσουάρ διαχείρισης
- ملحقات الإدارة
- 理线附件
- Вспомогательный аксессуар
- Accessorio di gestione

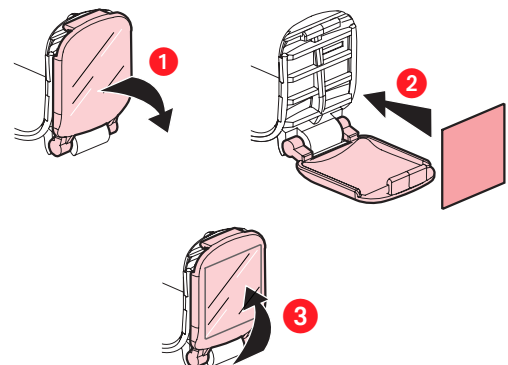
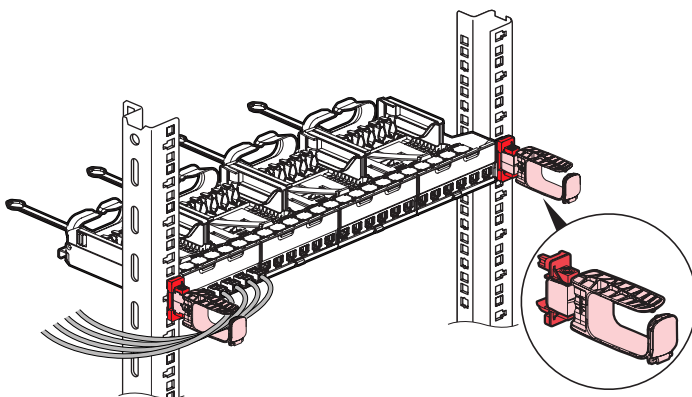
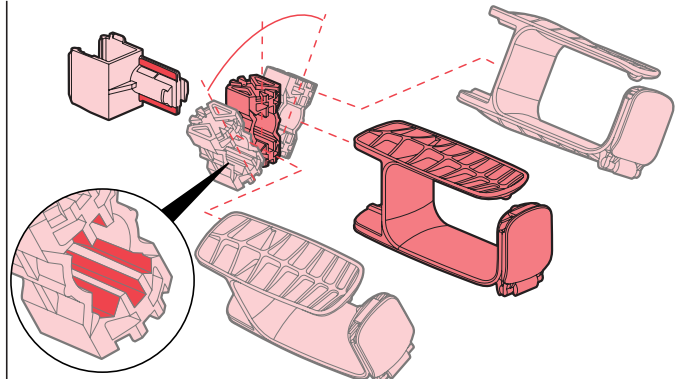
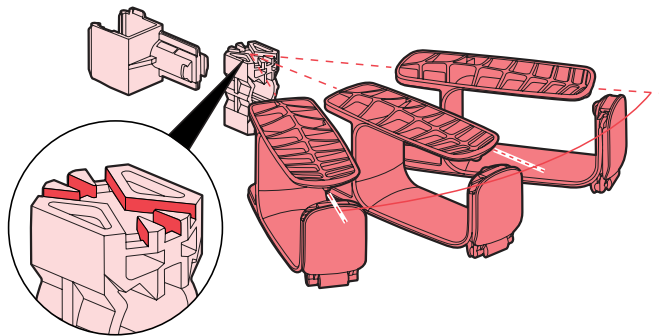

⚠ Consignes de sécurité (FR LU BE CH)
 Avant toute intervention, couper le courant.
 Respecter strictement les conditions d'installation et d'utilisation.

⚠ Veiligheidsvoorschriften (NL BE)
 Onderbreek voor enige ingreep de stroom.
 Neem de installatie- en gebruiksvoorwaarden nauwgezet in acht.

⚠ Safety instructions (GB IE)
 Make sure the power supply is disconnected before any intervention.
 Strictly comply with instructions for installation and use.

⚠ Sicherheitshinweise (DE CH)
 Vor jeglichem Eingriff die Spannungsfreiheit sicherstellen.
 Einbau- und Gebrauchsanleitungen sind genau zu beachten.

⚠ Consignas de seguridad (ES)
 Antes de realizar cualquier intervención, cortar la corriente eléctrica.
 Respetar estrictamente las condiciones de instalación y uso.

⚠ Instruções de segurança (PT)
 Antes de qualquer intervenção, desligar a corrente.
 Respeitar rigorosamente as condições de instalação e de utilização.

⚠ Συστάσεις ασφαλείας (GR CY)
 Πριν από οποιαδήποτε επέμβαση, διακόψτε την παροχή ρεύματος.
 Να τηρείτε ανστηρά τις συνθήκες εγκατάστασης και χρήσης.

⚠ Меры предосторожности (RU)
 Отключить питание перед проведением любых ремонтных работ.
 Строго соблюдайте требования к условиям монтажа и эксплуатации.

⚠ Istruzioni di sicurezza (IT CH)
 Prima di qualsiasi intervento, interrompere l'alimentazione.
 Rispettare scrupolosamente le condizioni d'installazione e uso.

⚠ 安全提示
 在任何干涉以前一定要断电，严格遵守安全和使用的规定。

إرشادات الأمان:
 «اقطع التيار الكهربائي قبل أي تدخل. تقيماً نقيداً تماماً بملصق التركيب والاستخدام.»