

0 337 57

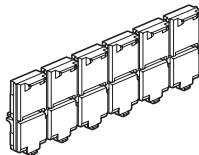

0 337 56

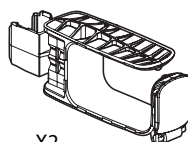

X2

0 337 59

SOMMAIRE

Page



1. CARACTERISTIQUES GENERALES 1
 2. MISE EN SITUATION 1
 3. CARACTERISTIQUES TECHNIQUES 1
 4. INSTALLATION 1
 5. COTES D'ENCOMBREMENT 3

1. CARACTERISTIQUES GENERALES

0 337 57 : Cassette obturatrice
 Permet d'obturer le panneau.

0 337 56 : Obturateur de ports
 Plaque obturatrice 6 ports sécables
 Permet d'obturer individuellement, partiellement ou totalement de 1 à 6 ports (cassette 6 ports) ou 1 à 12 ports (cassette HD).

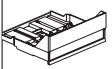
0 337 59 : Guide cordons
 2 guides cordons à clipser sur Soluclip nouvelle génération
 Permet la gestion latérale des cordons en les maintenant et en les orientant horizontalement et verticalement

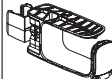
Désignation		Référence	Poids (g)
	Cassette obturatrice	0 337 57	39,6
	Obtuteur de ports	0 337 56	8,11
	Guide cordons x 2	0 337 59	32,4

2. MISE EN SITUATION

0 337 57 : Cassette obturatrice
 La cassette se clipse par l'avant, en lieu et place d'une cassette équipée, le déclipage se fait à l'aide d'un tournevis.

0 337 56 : Obturateur de ports
 L'obturateur de port sécable se clipse par le dessus de la cassette, à la place d'un connecteur. La sécabilité permet presque toutes les combinaisons pour des cassettes 6 ports ou 12 ports.

0 337 59 : Guide cordons
 Le guide cordon se clipse sur le soluclip gauche et droit du panneau. Les différentes positions possibles permettent un guidage parfait des cordons.

3. CARACTERISTIQUES TECHNIQUES

■ 3.1 Caractéristiques matière

0 337 57 : Cassette obturatrice
 Polycarbonate

0 337 56 : Obturateur de ports
 ABS

0 337 59 : Guide cordons
 ABS
 Polycarbonate : porte étiquette

■ 3.2 Caractéristiques climatiques

Températures d'utilisation : -10°C à +60°C
 Humidité : 5% à 85% (sans condensation)

4. INSTALLATION

0 337 57 : Cassette obturatrice
 Montage cassette obturatrice

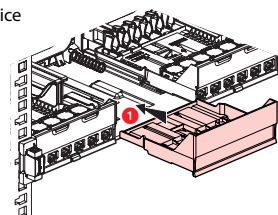

Démontage cassette obturatrice

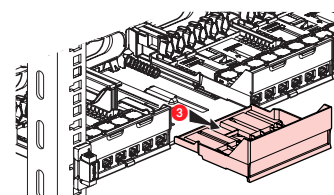
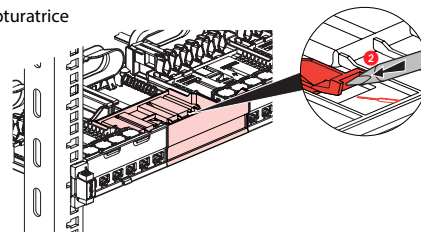

0 337 56 : Obturateur de ports

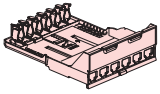

Sur cassette 6 pots 0 337 55

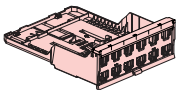
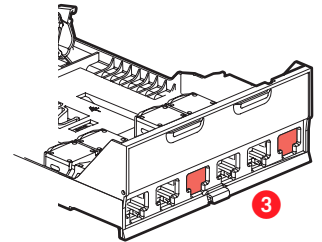
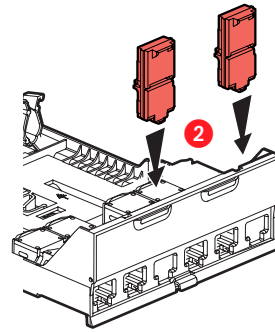
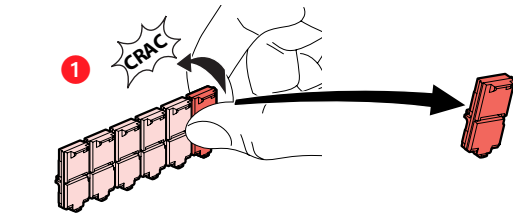
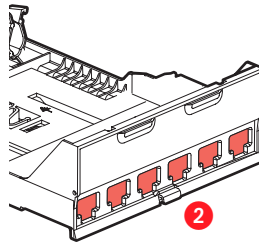
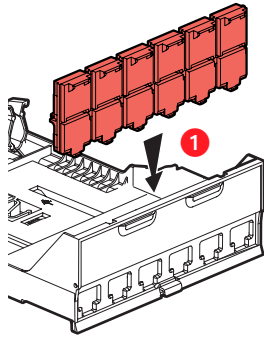

Sur cassette 12 pots 0 337 95

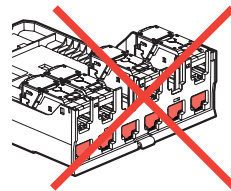
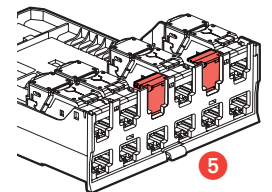
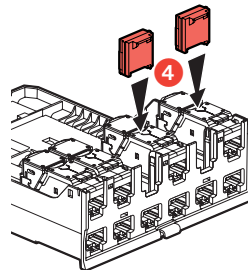
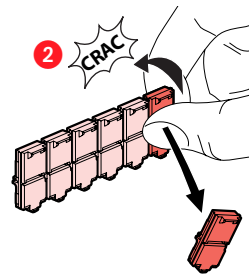
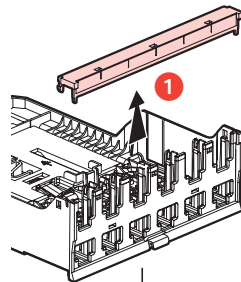
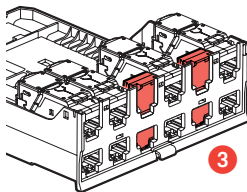
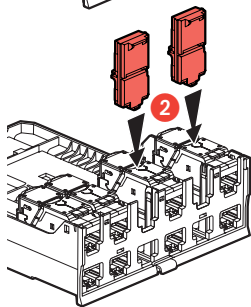
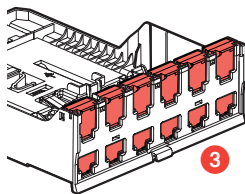
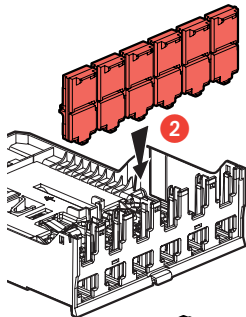

0 337 59 : Guide cordons

3 possibilités de guidage horizontal des cordons

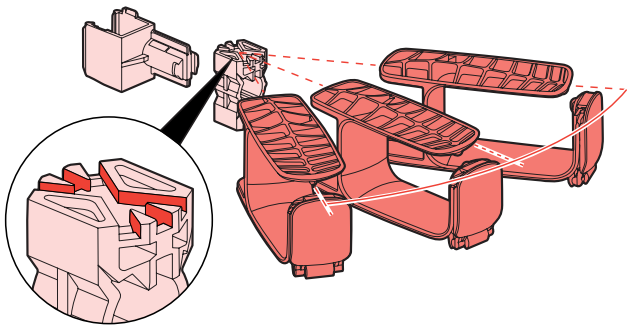

3 possibilités de guidage vertical des cordons

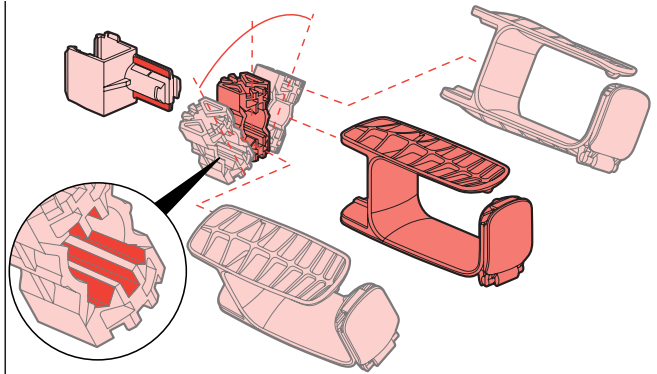

Le guide cordons se monte sur le nouveau soluclip

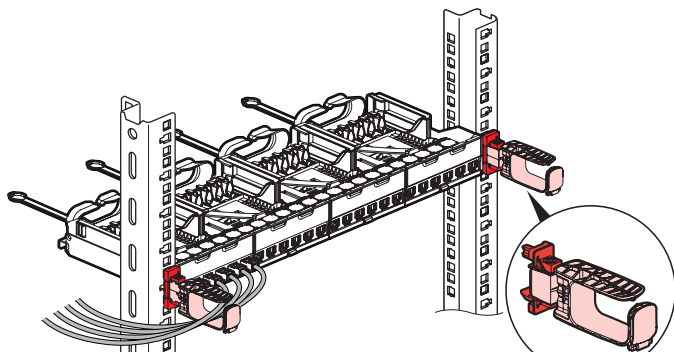

Porte étiquette permettant le repérage du U

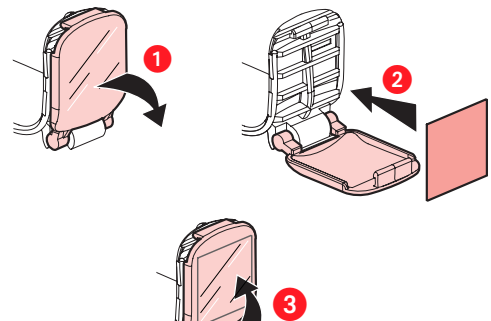

5. COTES D'ENCOMBREMENT

